

رسول
الله
ﷺ

HARUN YAHYA

A DEFINITIVE
REPLY TO
EVOLUTIONIST
PROPAGANDA





*In the name of God,
Most Gracious, Most Merciful*



All translations from the Qur'an are from *The Noble Qur'an: a New Rendering of its Meaning in English* by Hajj Abdalhaqq and Aisha Bewley, published by Bookwork, Norwich, UK. 1420 CE/1999 AH.

Edited by James Barham

PUBLISHED IN MALAYSIA BY :



SABA ISLAMIC MEDIA

1-2-1, Prima Peninsula,

Jalan Setiawangsa 11,

Taman Setiawangsa,

54200 Kuala Lumpur, Malaysia

www.saba-islamic-media.com

PRINTED BY:

Seçil Ofset

Istanbul/Turkey

Tel: +90 212 6290615

www.harunyahya.com



**A DEFINITIVE
REPLY**

TO

**EVOLUTIONIST
PROPAGANDA**

ABOUT THE AUTHOR

Now writing under the pen-name of HARUN YAHYA, he was born in Ankara in 1956. Having completed his primary and secondary education in Ankara, he studied arts at Istanbul's Mimar Sinan University and philosophy at Istanbul University. Since the 1980s, he has published many books on political, scientific, and faith-related issues. Harun Yahya is well-known as the author of important works disclosing the imposture of evolutionists, their invalid claims, and the dark liaisons between Darwinism and such bloody ideologies as fascism and communism.

His pen-name is a composite of the names *Harun* (Aaron) and *Yahya* (John), in memory of the two esteemed Prophets who fought against their people's lack of faith. The Prophet's seal on the his books' covers is symbolic and is linked to the their contents. It represents the Qur'an (the final scripture) and the Prophet Muhammad (peace be upon him), last of the prophets. Under the guidance of the Qur'an and the Sunnah (teachings of the Prophet), the author makes it his purpose to disprove each fundamental tenet of godless ideologies and to have the "last word," so as to completely silence the objections raised against religion. He uses the seal of the final Prophet, who attained ultimate wisdom and moral perfection, as a sign of his intention to offer the last word.

All of Harun Yahya's works share one single goal: to convey the Qur' an's message, encourage readers to consider basic faith-related issues such as God's Existence and Unity and the hereafter; and to expose godless systems' feeble foundations and perverted ideologies.

Harun Yahya enjoys a wide readership in many countries, from India to America, England to Indonesia, Poland to Bosnia, and Spain to Brazil. Some of his books are available in English, French, German, Spanish, Italian, Portuguese, Urdu, Arabic, Albanian, Russian, Serbo-Croat (Bosnian), Polish, Malay, Uygur Turkish, and Indonesian.

Greatly appreciated all around the world, these works have been instrumental in many people recovering faith in God and gaining deeper insights into their faith. His books' wisdom and sincerity, together with a distinct style that's easy to understand, directly affect anyone who reads them.



Those who seriously consider these books, can no longer advocate atheism or any other perverted ideology or materialistic philosophy, since these books are characterized by rapid effectiveness, definite results, and irrefutability. Even if they continue to do so, it will be only a sentimental insistence, since these books refute such ideologies from their very foundations. All contemporary movements of denial are now ideologically defeated, thanks to the books written by Harun Yahya.

This is no doubt a result of the Qur'an's wisdom and lucidity. The author modestly intends to serve as a means in humanity's search for God's right path. No material gain is sought in the publication of these works.

Those who encourage others to read these books, to open their minds and hearts and guide them to become more devoted servants of God, render an invaluable service.

Meanwhile, it would only be a waste of time and energy to propagate other books that create confusion in people's minds, lead them into ideological chaos, and that clearly have no strong and precise effects in removing the doubts in people's hearts, as also verified from previous experience. It is impossible for books devised to emphasize the author's literary power rather than the noble goal of saving people from loss of faith, to have such a great effect. Those who doubt this can readily see that the sole aim of Harun Yahya's books is to overcome disbelief and to disseminate the Qur'an's moral values. The success and impact of this service are manifested in the readers' conviction.

One point should be kept in mind: The main reason for the continuing cruelty, conflict, and other ordeals endured by the vast majority of people is the ideological prevalence of disbelief. This can be ended only with the ideological defeat of disbelief and by conveying the wonders of creation and Qur'anic morality so that people can live by it. Considering the state of the world today, leading into a downward spiral of violence, corruption and conflict, clearly this service must be provided speedily and effectively, or it may be too late.

In this effort, the books of Harun Yahya assume a leading role. By the will of God, these books will be a means through which people in the twentyfirst century will attain the peace, justice, and happiness promised in the Qur'an.



TO THE READER

All the author's books explain faith-related issues in light of Qur'anic verses, and invite readers to learn God's words and to live by them. All the subjects concerning God's verses are explained so as to leave no doubt or room for questions in the reader's mind. The books' sincere, plain, and fluent style ensure that everyone of every age and from every social group can easily understand them. Thanks to their effective, lucid narrative, they can be read at a one sitting. Even those who rigorously reject spirituality are influenced by the facts these books document and cannot refute the truthfulness of their contents.

This and all the other books by the author can be read individually, or discussed in a group. Readers eager to profit from the books will find discussion very useful, letting them relate their reflections and experiences to one another.

In addition, it will be a great service to Islam to contribute to the publication and reading of these books, written solely for the pleasure of God. The author's books are all extremely convincing. For this reason, to communicate true religion to others, one of the most effective methods is encouraging them to read these books.

We hope the reader will look through the reviews of his other books at the back of this book. His rich source material on faith-related issues is very useful, and a pleasure to read.

In these books, unlike some other books, you will not find the author's personal views, explanations based on dubious sources, styles that are unobservant of the respect and reverence due to sacred subjects, nor hopeless, pessimistic arguments that create doubts in the mind and deviations in the heart.

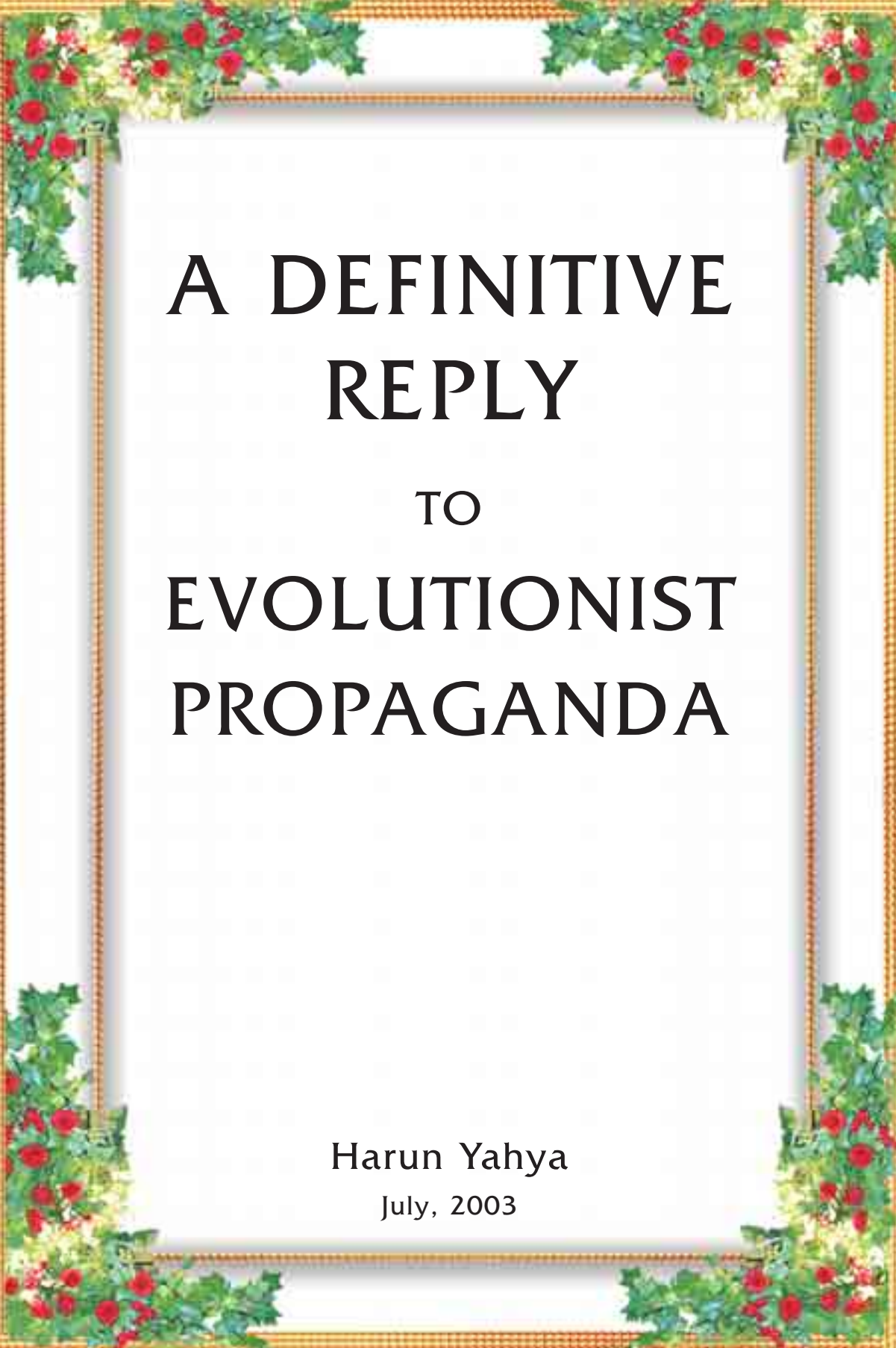

**A DEFINITIVE
REPLY
TO
EVOLUTIONIST
PROPAGANDA**

Harun Yahya

July, 2003



CONTENTS

Introduction	10
A Series Of Blunders Regarding Monkey Intelligence From National Geographic TV	12
The Smuggling Incident National Geographic TV Declined To Cover	26
National Geographic TV's Undersea Fairy Tales.....	30
Tall Tales From The National Geographic Channel	38
Tales Of Transformation From National Geographic Television	54
The "Mitochondrial Eve" Deception On The Discovery Channel.....	74
The Dino-Bird Fantasy On The Discovery Channel.....	82
Errors Concerning Human Intelligence From The Discovery Channel.....	86
The Discovery Channel's Spider Dilemma	104
Evolutionist Propaganda On The History Channel.....	110
The History Channel's Darwinist And Atheist Propaganda	118
New Scientist's Latest Myth: "Hiccups Are A Legacy From Evolution".....	128
<i>New Scientist's</i> "Evolution With Climate" Error	132
Paul Davies' Desperate Case For A "Multiverse".....	138
Evolutionary Tall Tales From The BBC – I –	146
Evolutionary Tall Tales From The BBC – II –	168
Evolutionary Tall Tales From The BBC – III –	178
The BBC's Functionless Tissue Error In Its Documentary <i>The Human Body</i>	186
BBC's Evolution Of The Human Brain Error	190
The Evolutionist Deceptions In The Documentary <i>The Shape Of Life</i>	202
Evolutionist Deceptions Continue With The Arthropods In <i>The Shape Of Life</i> Documentary.....	208
The Evolutionists Are Still Struggling With The Same Dilemma: The Origin Of Flight	220
New Fossil Discoveries Pose A New Dilemma For The Theory Of Evolution	240
The Latest Version Of Baseless Evolutionist Scenarios In Scientific American: Nutrition	244
<i>Time</i> Writer M. Lemonick's Mind-Body Error	252



INTRODUCTION

Between early 2001 and the present day there have been a number of very interesting and important developments in the world of science. The advances made in such different scientific fields as palaeontology, molecular biology, anatomy and genetics have once again revealed the terrible scientific dilemma the theory of evolution finds itself in. The theory of evolution was proposed in its present form in the mid-19th century by Charles Darwin and at that time provided enormous support for materialism. Such was that support that the present collapse of the theory is also resulting in the collapse of materialism itself.

Materialism is a most dangerous philosophy, which denies the existence of God, religion and the spiritual life and which regards matter as the only absolute and supports a selfish world view. The selfish, self-interested, combative and ruthless moral view which is still widespread in the world is the product of a materialist-Darwinist viewpoint.

It is therefore essential to inflict an intellectual defeat on the materialist world view, and to this end it is essential to reveal the scientific invalidity of Darwinism, which constitutes the basis of that view. This is an easy task, because Darwinism lacks any scientific foundation. Not one scientific proof to back up the theory of evolution has so far been found in any relevant branch of science. The findings which have been made all show that evolution never happened. All that evolutionists do is to distort certain biological phenomena, observations or the fossil record, none of which actually constitute any evidence for the theory of evolution, in a prejudiced manner, and sometimes even wage their propaganda campaign by engaging in scientific fraud.

In order for the true face of Darwinism to be revealed it is therefore essential that the effect of this propaganda be nullified and that the scientific facts be made available to as many people as possible. The subsequent chapters of this book therefore examine the new scientific findings which unmask the evolution deception as well as the invalidity of the one-sided reports which have appeared in evolutionist publications and media outlets in recent months.

**A SERIES OF BLUNDERS
REGARDING MONKEY
INTELLIGENCE**

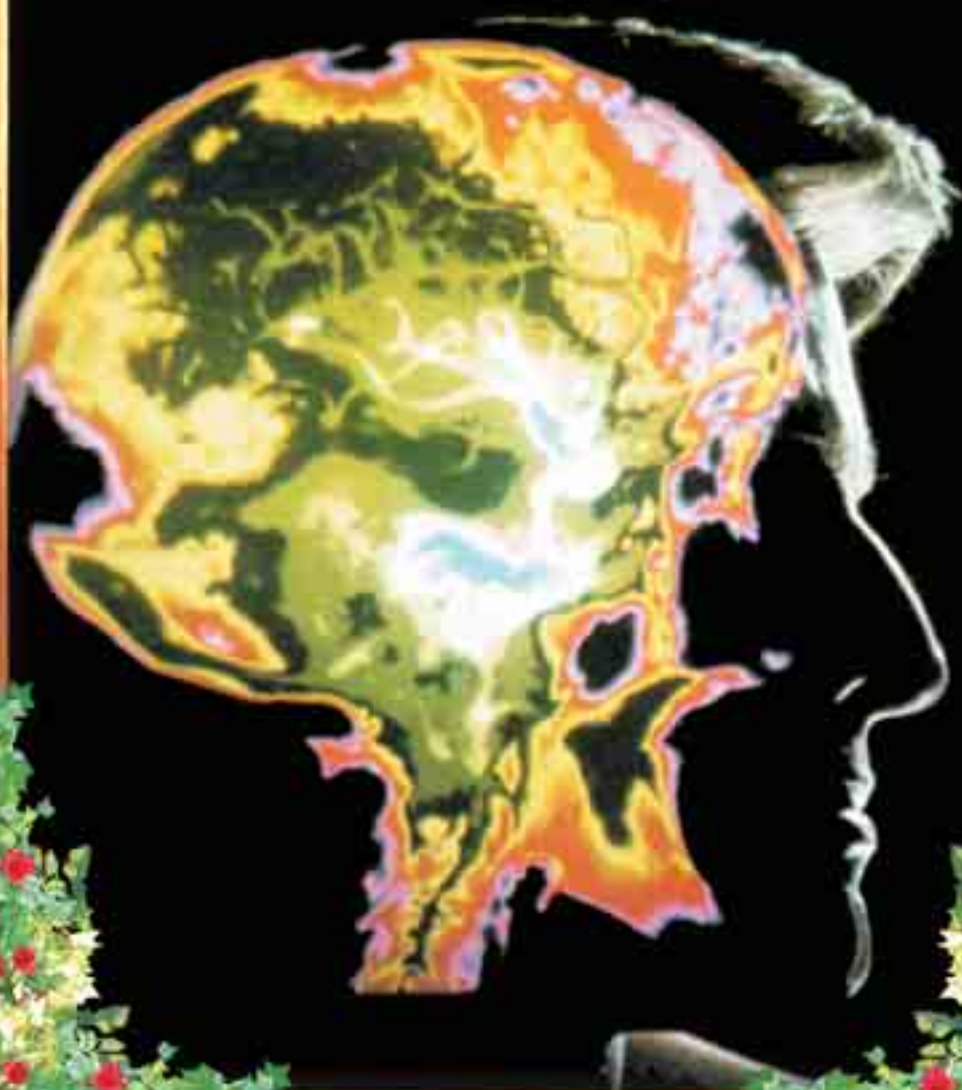

National Geographic TV broadcast two documentaries in April 2003 in its Europe edition. Called *A Tale of Three Chimps* and *My Favorite Monkey*, these documentaries bore clear similarities in terms of the message they sought to give. The consecutive broadcasting of these documentaries by National Geographic TV, their subject matter, and their timing indicated that deliberate evolutionist propaganda was going on. This channel, which in March 2003 brought us the fairy tales of "the dog that entered the sea and became a whale" and "the fish that left the sea and grew legs" in its *Great Transformations*, this time offered us another story and tried to inculcate the suggestion of the alleged evolution of man.

The documentary "A Tale of Three Chimps" dealt with chimpanzees working in a circus, and "My Favorite Monkey" was about the tailed macaque. Throughout both of these films frequent examples were given of what appeared to be intelligent behavior in monkeys, and the impression was given that since monkeys are so-called close relatives of man, their intelligence is correspondingly high. The aim of this article is to reveal the twisted Darwinist interpretations given in both documentaries.

Claims That Chimpanzees and Man are Brothers or Genetic Relatives are Untrue

Right at the beginning of the film there is talk of chimpanzees' being a "brother species" to man and it was said that scientists realized the similarities between the two species before their genetic proximity was confirmed.

National Geographic TV's view of monkeys as a "brother species" to man is nothing more than Darwinist prejudice and rests on no scientific findings. There is absolutely no evidence to support the claim that man and apes evolved from a common ancestor. In

A DEFINITIVE REPLY
TO EVOLUTIONIST
PROPAGANDA

the face of the picture presented by the fossil record, evolutionist paleontologists admit that they have abandoned hope of finding a missing link between man and the chimpanzee.

The claim that a "genetic proximity" between man and ape has been confirmed is a deception, pure and simple. Genetic proximity is a scenario produced as the result of a distortion of data regarding human and chimpanzee DNA with the aim of supporting Darwinism. However, this scenario is rotten to the core, because it claims that DNA emerged by means of so-called random evolutionary mutations. The fact is, however, that the effects of mutations on organisms are inevitably harmful, and may even have fatal results. DNA contains meaningful information recorded in a special encoding system. Random mutations in genes cannot possibly add new information to the DNA of the organism and turn it into a new species. All experiments and observations on mutations demonstrate this.

Moreover, the invalidity of the figures put forward in this genetic proximity propaganda has also emerged in new scientific discoveries in recent months. The findings of a California Institute of Technology geneticist have revealed that the genetic difference between man and chimpanzee was three times greater than had been claimed.¹ It was revealed that there is absolutely no scientific proof of a point that is so frequently stressed in evolutionist propaganda. (For more details about the scientific discoveries which have undermined the scenario of human evolution, see *Darwinism Refuted*, by Harun Yahya at www.harunyahya.com under the subtopic "Refutation of Darwinism.")

The National Geographic TV documentary, "My Favorite Monkey," states that man and apes possess a similar physiology, and this is portrayed as evidence of evolution.

Space is devoted to the comments of a veterinarian regarding a monkey which was brought to him for treatment. The veterinarian states that some of the medicines he used for the monkey were actually human medicines, and cites this as evidence that the two species are related.

The fact, however, that medicines can prove to be effective in both species provides no evidence

for the theory of evolution whatsoever.

The comparison is merely one made in line with Darwinist prejudices. It is quite natural that similar chemicals should benefit both man and apes. Both species share the same biosphere and the same carbon-based organic molecules. This common structure applies not just to man and apes, but to the whole of nature. For instance, human beings produce medicine from the blood of the horseshoe crab. Yet this does not mean that man and the horseshoe crab are related. On the other hand, kidney transplants carried out from chimpanzees to human beings represent a serious blow to the claims of similar physiology. Dr. Keith Reemtsma of Tulane University carried out more than a dozen such transplants from chimpanzees to human beings in 1963, but all the

patients died.² That is because the chimpanzee metabolism worked faster, for which reason the cells in the tissue of the chimpanzee kidney rapidly consumed the water in the bodies of the human recipients.

National Geographic TV's Propaganda Tactics

The propaganda tactic so often resorted to in documentaries on National Geographic TV consists of showing examples of intelligent behavior by apes and then drawing comparisons between them and human beings. This tactic can be seen in expressions like "they are intelligent animals," "their needs closely resemble those of human beings," and "like us, they feel the need for personal bonds and interpersonal relationships."

The commentary in *My Favorite Monkey* mentions that apes produce creative solutions in the face of problems in nature and that they are intelligent problem-solvers. It says the line between human and ape behavior may be very unclear.

In another narration, it is stated that they resemble us physically; we use them in space and medical research. Also, they resemble us socially, but we keep that to ourselves. Family life is very important among members of the macaque species and we are so closely related that ...

Yet the inconsistency of constructing an evolutionary link between man and ape in respect of intelligence and interpersonal relationships is quite evident. There are other animals far superior to apes when it comes to intelligence and relationships. Bees, for instance, are able to employ the kind of architecture in building their combs that only a mathematician's calculations could match.³ A geometrical plan can be seen in the comb, one that allows the least possible material to be used in the construction but the greatest possible amount of area for storage. (In the identification of such an "optimal" design the area and circumferences of different geometrical shapes need to be calculated, and the geometric shape with the



The assumptions which evolutionists accept without really thinking about them are actually based on very weak foundations. Evolutionists feel enormous excitement at ape behavior which is similar to that of humans, yet ignore other creatures which display even more intelligent behavior than apes.



According to evolutionists' own logic, it is possible to draw a comparison between bees, which build combs that are architectural marvels, or beavers, which construct dams, with civil engineers and say that they are our ancestors. That claim is as nonsensical as saying we are descended from apes.

**A DEFINITIVE REPLY
TO EVOLUTIONIST
PROPAGANDA**

highest area/circumference ratio should be selected.)

In the same way, beavers are able to build their nests against the current in the middle of rivers, employing the kind of engineering abilities used by man in constructing dams.⁴ Termites build magnificent towers capable of comparison with our own skyscrapers, and set up air-conditioning systems, special storage chambers and agricultural areas inside them. The fact, of course, that they display a visibly sensitive mathematical and geometrical knowledge in their buildings and use engineering techniques does not imply that we are related to bees, beavers, or termites.

Neither is the fact that monkeys feel the need for interpersonal bonds and relationships evidence for evolution. Creatures that have no possible relation to human beings also enjoy similar bonds and relationships. Penguins, for example, raise families full of love and loyalty. Dogs are much more faithful and friendly in the relationships they establish with human beings. Doves enjoy close relations with their mates. Budgerigars exhibit enormous interest and devo-



tion to one another, and also to human beings. Yet these features do not make penguins, doves, budgerigars, and dogs our relatives.

On the other hand, these animals do reveal the invalidity of the theory of evolution's claims regarding the origin of their intelligence and behavior. Despite the fact that the creatures we have just listed are located on branches of the imaginary evolutionary tree far more distant from man than are chimpanzees, they are still able to display behavior much closer to human intelligence than that of chimpanzees.

Honeybees reveal yet another contradiction which the theory of evolution is quite incapable of accounting for. The theory seeks to account for level of intelligence by the development of the nervous system. For instance, it links the fact that man is the most highly developed living thing to his having the highest brain/body ratio. According to this logic, chimpanzees, with a much more complex nervous system than that of bees, should be far superior to them. Yet the truth is actually the exact opposite. The fact that a creature much further away from man on the imaginary evolutionary tree than the chimpanzee is able to display the kind of complex behavior seen in man, despite its being a simple organism, – the way it calculates the surface area and circumference of the hexagon and measures internal angles, for instance – definitively invalidates the evolutionist claims with regard to ape intelligence.

Beware the Monkey Culture Distortion

In the documentary *My Favorite Monkey* it is suggested that the tailed monkey known as the macaque possesses the ability to develop complex behaviors, and to teach them to individuals and so hand them on to subsequent generations. This is described as a kind of "monkey culture," on the grounds that such learned behavior falls within the meaning of culture.

It may be suggested that the behavior models peculiar to one living species are an indication of "culture." However, as we have

A DEFINITIVE REPLY
TO EVOLUTIONIST
PROPAGANDA

stated above, "human-type" behavior or the demonstration of a "human-type" culture in certain aspects by a living being is again no evidence for the theory of evolution.

National Geographic TV engages in two major distortions here. First, the example is given of a macaque washing the sand off a potato in the sea before eating it. Second, an adult macaque is shown forcibly taking the stones a younger monkey is playing with out of its hand.

It is stated that the washing of the potato in water is behavior that was first developed by one macaque in the group and then taught to the others. This is taken to be a sign of culture. The taking away by the adult of the stone the younger macaques are playing with is compared to the way that children playing in a nursery take each other's toys. It is suggested here that the way the adult engages in a display of strength by taking it away from the younger animal shows that macaques imbue the stone with a kind of social significance.

The fact that a monkey engages in "humane" cleaning and displays a "toy" culture cannot be put forward as evidence for evolution. Evolutionists persistently fixate on monkey culture, and are accustomed to portray this as a whole entity, based on particular communication between monkeys. The aim here is to install the idea in people's minds that human culture is a phenomenon which emerged with evolution, and that among animals the nearest level to human culture is that exhibited by monkeys.

Yet the wild bee known as *schwarzula* or the leafcutter ant exhibit an even more complex culture – that of agriculture. *Schwarzula* engages in "livestock rearing" by making use of secretions from a species of larva it gathers up and collects in its nest. Leafcutter ants engage in "agriculture" by growing fungus.⁵ Another species of ant collects resin from trees and uses this as an antiseptic to purify its nest from germs. This is a sign of a "culture of medicine." The way that creatures which (according to evolutionists) are "simpler" than apes and much further removed from man than



Due to the symbiosis of leaf cutter ants and fungi, the ants obtain the protein they need for nutrition from the mushroom buds they grow on leaves. Here we see a mushroom garden tended by ants.

1) Inside the nest, slightly smaller workers chop leaves into bits.

2)The next caste chews these bits into pulp and fertilizes them with deposits of enzyme-rich fecal fluid.

3) Other ants apply the fertile leaf paste over a base of dried leaves in new chambers.

4) Another caste hauls in bits of fungus from older chambers and plants them in the leaf paste. Bits of fungus spread on the leaf paste like frost.

5) A teeming caste of dwarfs cleans and weeds the garden, then harvests the fungus for others to eat.



apes, are able to display such complex examples of culture is enough to invalidate the evolutionists' claims of a link between "monkey culture" and man.

As we have seen, National Geographic TV's distortions are insufficient to account, according to the theory of evolution, for behavior and culture among animals that are similar to those in man. Moreover, the examples we have cited of behavior and culture in bees, ants, beavers, dogs, and doves raise certain questions that can never be answered in terms of the theory of evolution: How did these creatures come by the necessary information to accomplish such complex behavior? How are they able to interpret such information? How is it that tiny insects are able to display more complex behavior than apes, alleged to be man's closest relatives?

You can ask these questions to the evolutionist of your choice. It is absolutely certain that the reply will demonstrate the total quandary they find themselves in. Those with rather more experience will try to gloss over the matter by saying such behavior depends on "instinct." Yet that fails to save the theory that is deadlocked. "Instinct" is nothing more than a name generated for this evolutionary quandary.

It is obvious that instinct does not stem from the living thing itself, but is inspired by a superior intelligence. It is God Who inspires the behavior in bees, beavers, dogs, doves, and chimpanzees. Every living thing displays the characteristics God set out for it. The fact that the chimpanzee is an animal, which man finds amusing and which is able to obey his commands, stems from the inspiration God places in it. The truth of this can be seen in the verse of the Qur'an; **"Your Lord revealed to the bees..."** (Qur'an, 16:48)

Monkey Blunders from National Geographic TV

The claims put forward in the comparisons between the tailed macaques and man in the documentary "My Favorite Monkey" are so utterly inconsistent that the film gives the impression of having

been prepared as an entertainment for children. For instance:

The experimental monkeys sent into space are referred to as heroes, and we are told, had it not been for them man could never have taken the giant leap into space that he did. This is a totally baseless comment: The monkeys sent into space did not "succeed" in doing anything. The rockets they were placed into were controlled from earth, and the monkeys were just tightly strapped into the cabins and used as experimental subjects.

Furthermore, even if we do allow a measure of heroism in the experimental animals used in space research, then rats and dogs must also be included, since these too were used in craft sent up into space.

It is also stated in *My Favorite Monkey* that apes have been of major use to man in the medical field. We are told how, as a result of research on rhesus monkeys, the Rh tests were developed. Obviously, though, the use of an animal in medical research does not make it a relative of man, in the same way that the use of bacteria in the development of antibiotics does not make them relatives of man.

In that same documentary, a comparison is made between the way that monkeys groom each other to remove fleas and parasites and the way that human beings go to the hairdresser, and it is suggested that going to the hairdresser is parallel social behavior to being groomed for fleas.

**A DEFINITIVE REPLY
TO EVOLUTIONIST
PROPAGANDA**

This claim must represent a "shining example" of the way in which National Geographic TV's Darwinist fantasies know no limits. Maybe in future programs this creative imagination could be used to engage in speculation regarding the origin of the human habit of going to the theatre by showing two groups of apes, the one watching the other group playing. That is, of course, if termites are not rediscovered with their construction abilities and put forward as man's nearest ancestors!

Macaques' jumping onto jet skis, skiing, or sitting and eating in

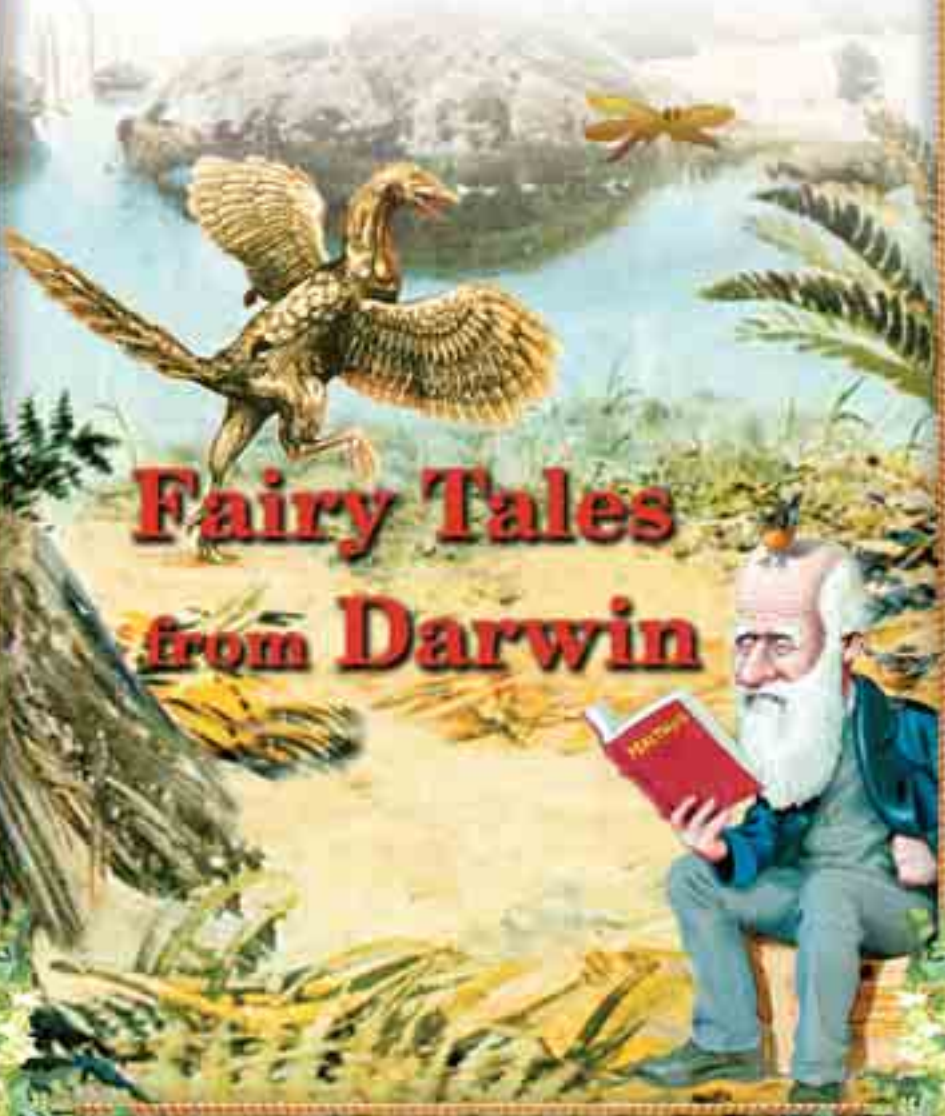

restaurants with their owners does not make them relatives of man. It is clear that such behavior does not have its roots in ape etiquette or culture. Such behavior is the result of punishment and reward training, and has no more significance than a circus show. Indeed, dogs, birds, and dolphins are also used in such shows and demonstrate impressive abilities. National Geographic TV is using and distorting such images of monkeys to implant in people's minds the idea set out in evolution that the monkeys are man's closest relatives.

Conclusion

These documentaries broadcast on National Geographic TV once again show that the channel is a blind and dogmatic supporter of Darwinism. The claims put forward about animal behavior and intelligence make no scientific statement at all. This channel, which declares the apes sent into space to be heroes and tries to establish an evolutionary link between monkeys grooming each other and human beings going to the hairdresser, is trying to cover claims that even children would find laughable with a scientific veneer. We recommend that if the channel is to defend the theory of evolution, it should try to find more rational and logical arguments with which to do so.

1. "Chimps Humans only 95% Similar," <http://www.cnn.com/2002/TECH/science/09/24/humans.chimps.ap/index.html>
2. Daniel Q. Haney, "Scientists choose a transplant donor that's smart, plentiful and kind of cute," Associated Press, 08.04.2001.
http://www.boston.com/news/daily/04/pig_transplant.htm
3. *The Miracle in the Honeybee*, Audio Book: 3.
http://www.harunyahya.com/m_audio.php#a8
4. Harun Yahya, *For Men of Understanding*, Ta-Ha Publishers, January 2001
5. Harun Yahya, *The Miracle in the Ant*, Goodword Books, 2001

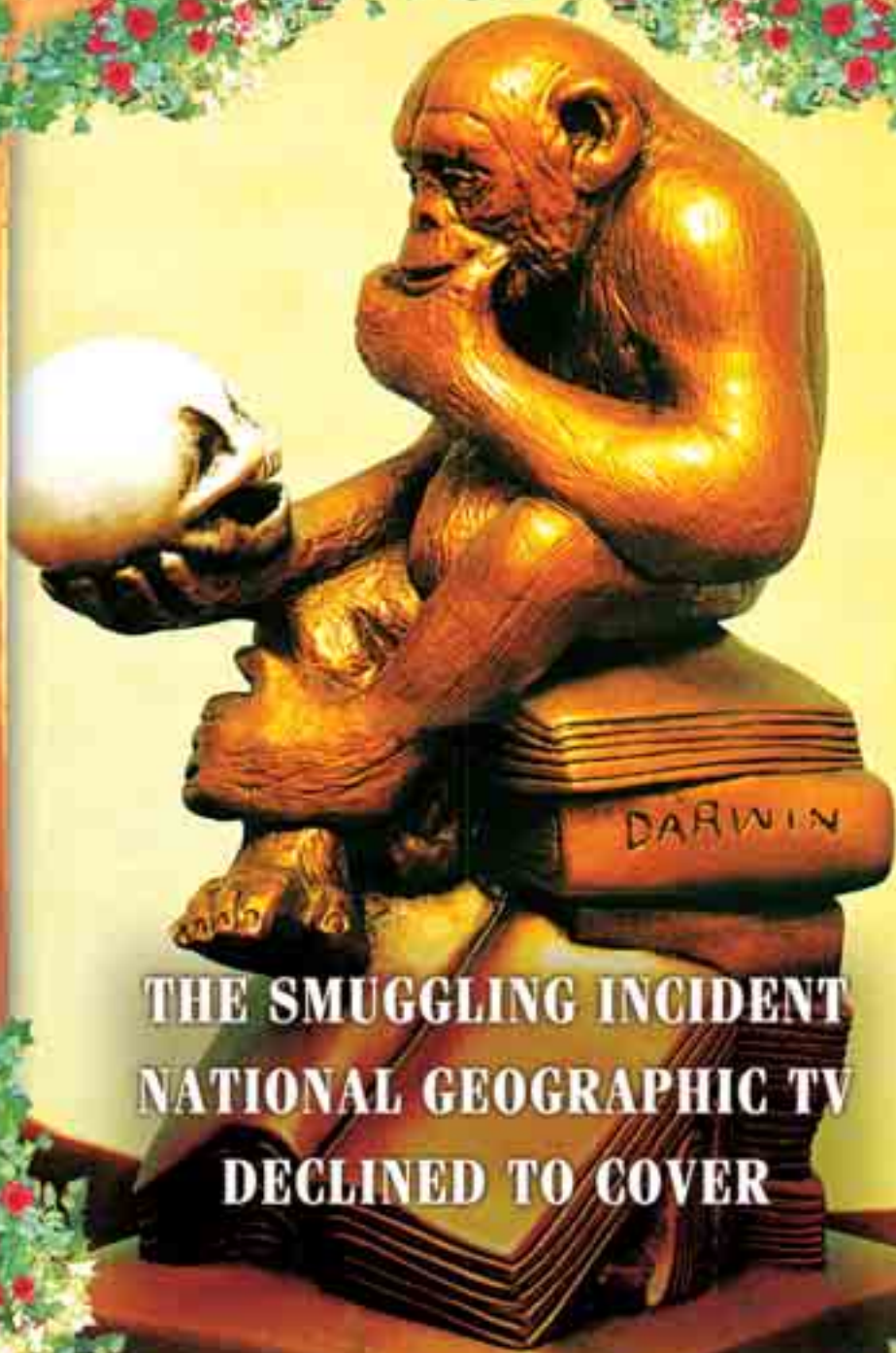

**THE SMUGGLING INCIDENT
NATIONAL GEOGRAPHIC TV
DECLINED TO COVER**

Two documentaries called *Dinosaur Dealers* have been broadcast on National Geographic TV. These dealt with the trade in fossils and fossil smuggling, and described the adventures of a paleontologist who followed in the tracks of a number of stolen fossils, or fossils smuggled out of Australia. The trail was followed detective-style, and the program showed the negotiations carried out in order to trap the smugglers. In this way, the impression was given that *National Geographic* is an idealistic body, chasing hot on the heels of smugglers and striving with all its might to destroy this illegal trade. However, the TV channel failed to mention that just a few years ago it too was involved in smuggling an *Archaeoraptor* fossil (and the fraud that accompanied it). In fact, it said not a word about it.

Let us recall the details of that smuggling operation.

Archaeoraptor liaoningensis was a forged dino-bird fossil. The remains of the creature, alleged to be an evolutionary link between dinosaurs and birds, had apparently been unearthed in the Liaoning area of China and were published in the November 1999 edition of *National Geographic* magazine.

Stephen Czerkas, an American museum administrator, had bought the fossil from the Chinese for \$80,000, and then showed it to two scientists he had made contact with. Once the expected confirmation had been received, he wrote a report about the fossil. Yet Czerkas was no scientific researcher, nor did he hold a doctorate of any sort. He submitted his report to two famous scientific journals, *Nature* and *Science*, but they both declined to publish it unless it was first vetted by an independent commission of paleontologists.

Czerkas was determined to have this fantastical discovery published, and he next knocked at the door of *National Geographic*, known for its support of the theory of evolution.

Under Chinese law it was definitely forbidden to remove fossils unearthed within its borders from the country, and fossil-smuggling

A DEFINITIVE REPLY
TO EVOLUTIONIST
PROPAGANDA

Pittdown bird

A "missing link" in avian evolution was nothing of the sort

A 1996 report appears to be a head-scratcher for many evolutionists. It describes a fossilized tail from a dromaeosaur, a dinosaur with egg on their hips.

At a press conference in Washington DC last October, the National Geographic Society unveiled the fossil's history of fact and fiction. It was a "missing link" in the complex chain that connects dinosaurs to birds.

Some scientists, however, were not convinced. "This is a fossilized tail of a dinosaur, not a bird," says Martin, who



Pittdown bird

A "missing link" in avian evolution was nothing of the sort

A 1996 report appears to be a head-scratcher for many evolutionists. It describes a fossilized tail from a dromaeosaur, a dinosaur with egg on their hips.

At a press conference in Washington DC last October, the National Geographic Society unveiled the fossil's history of fact and fiction. It was a "missing link" in the complex chain that connects dinosaurs to birds.

who had found the fossilized tail of a dinosaur tail to it. "They found long tails attached to it," he says.

Despite having extensive paleontological knowledge, he called it a bird. Archaeopteryx was just a primitive dinosaur species. "One may discover parts of fossils with the same bird," says Martin, who

Mix and match: Archaeopteryx seems to consist of the tail of a dromaeosaur (above), glued to a fossil bird's body (below)



Thus, the *Archaeopteryx* fossil is similar to the earlier Pittdown Man fraud committed by evolutionists. *Archaeopteryx* was even described under the headline "Pittdown Bird" in the well-known magazine *New Scientist*. The report states that *Archaeopteryx* was formed by adding the tail of a dromaeosaur, a genuine dinosaur, to a bird fossil, and that this was a fraud perpetrated in the name of science.

could be severely punished, even by death. Despite being well aware of this, *National Geographic* accepted this fossil which had been smuggled out of China. The fossil was presented to the media at a press conference staged in the *National Geographic* headquarters in October 1999. An illustrated seven-page article describing the dino-bird fairy tale formed the cover story in the November edition of *National Geographic* magazine. Moreover, the fossil was exhibited in the National Geographic museum, where it was presented to millions of people as definitive proof of the theory of evolution.

The truth emerged in March 2001: no such intermediate species as *Archaeoraptor* had ever existed. Computer tomography analyses of the fossil revealed that it consisted of parts of at least two different species. *Archaeoraptor* was thus dethroned, and took its place alongside all the other evolutionist frauds in history. Darwinism—whose claims have never been empirically verified in the past 150 years—was once more associated with specially manufactured fossil forgeries.

As we have seen, *National Geographic* was once party to that very fossil-smuggling which it now purports to oppose. Naturally, the fact that in its latest documentaries it devotes space to bringing fossil smuggling out into the open may be regarded as a positive sign that it will not tolerate similar abuses in the future. However, if the TV channel does oppose fossil-smuggling, then it must also deal with such well-known smuggling incidents as *Archaeoraptor* in its programs. No matter how much of a violation of its Darwinist broadcasting policy it might be, admitting its past mistakes and taking the side of the truth would be commendable behavior in the sight of all its viewers.

**NATIONAL GEOGRAPHIC TV'S
UNDERSEA FAIRY TALES**

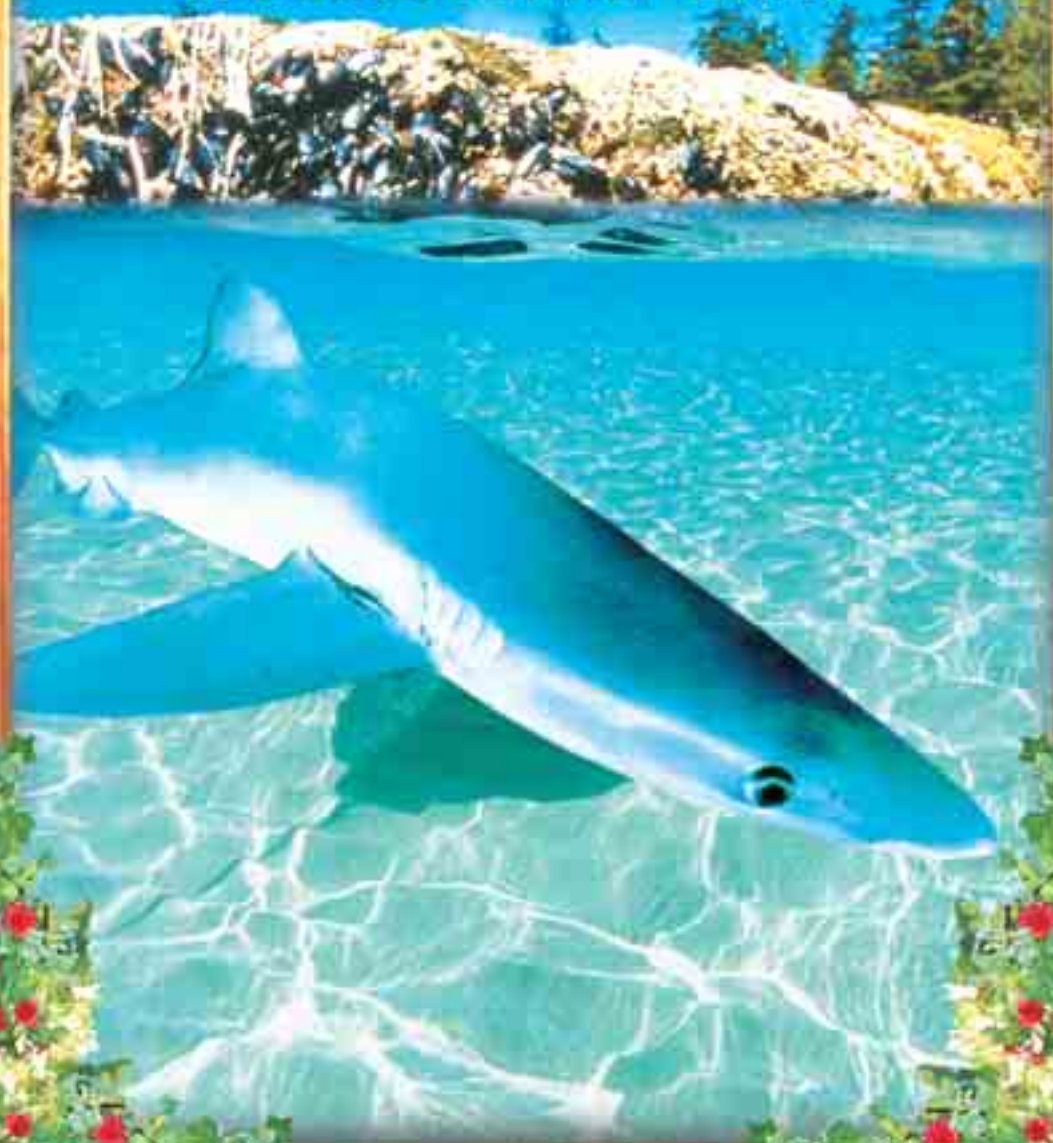

A documentary called *Built for the Kill* has been screened on National Geographic TV. Its aim was twofold. On the one hand, the program described some of the techniques used by sea creatures to hunt or evade capture. On the other, it sent out a Darwinist message by describing some creatures as "programmed to kill" or "ruthless killers."

The flawless design in the creatures described in the documentary were portrayed as mechanisms "developed for survival," although no evidence of this was offered. This is a technique frequently encountered in broadcasts by National Geographic TV and similar Darwinist institutions. However, it is obvious that these descriptions lack any scientific basis, since looking at the features possessed by the creatures and saying "they developed these in order to survive" or sticking an evolutionary label on the design in living things is itself of no scientific value.

For instance, attempting to account for the shiny skin on the underside of the blue shark and the dark skin on the top by means of evolution, while failing to provide any evidence, merely reveals National Geographic TV's prejudices. Another fish, looking down, cannot make out the shark against the dark tones of the sea bottom thanks to the dark color of the shark's skin. The shark will similarly be camouflaged against the brightness of the sea surface stemming from the rays of the sun. If this is to be explained by evolution, then it must also be explained how the information for this camouflage design emerged by chance in the creature's DNA, and scientific proof must be given. Maintaining that this information came about by natural selection and random mutations, in the absence of any scientific evidence whatsoever, is merely Darwinist dogma.

On the other hand, this feature of the shark can be perfectly convincingly accounted for by intelligent design: the information regarding which areas of the shark's skin are to be which colors is present in its DNA. It is utterly rational and scientific to maintain that the encoding of this information came about not by chance but

by conscious intervention.

The fundamental factor, which reveals the invalidity of the evolutionist claims put forward in the film, is the exceedingly complex nature of the design in the creatures discussed. The dolphin sonar dealt with in the documentary is one instance of this. Dolphins possess a special organ in their heads that allows them to send out sound waves and sense the echoes that reflect from physical bodies. These sound waves can penetrate some 30 cm beneath the sand and can be picked up in an amazing way by the dolphins as the environment changes (from water to sand and back from sand to water). In this way the dolphin plots a sort of map of what lies beneath the sand.

Another aspect indicative of the perfection in dolphin sonar is the way the U.S. Navy has imitated it in its own development of sonar. Since existing forms of sonar were unable to locate mines buried in the sand during the Gulf War, the U.S. fleet lost a number of ships. It then set out to use the dolphin wave range in the research it supported and to employ the dolphin's sensory technique in its own vessels.

Whitlow Au, a researcher from the Hawaii Marine Biology Institute in Kailua, together with his colleagues, managed to come up with such a sonar system four years ago. A computerized sonar device which monitored and decoded the echoes of the waves it sent was added to this artificial dolphin sonar. This sonar, developed by scientists, was subjected to a number of tests and produced very positive results, registering a 90% success rate in locating mines buried 40 cm under the sand.¹

As we can see, an advanced computer needs to be used in order to imitate the action of dolphin sonar. This animal's sonar faculty, which does what an advanced computer can do but in an even more efficient manner, and which is also far more com-



Whitlow Au

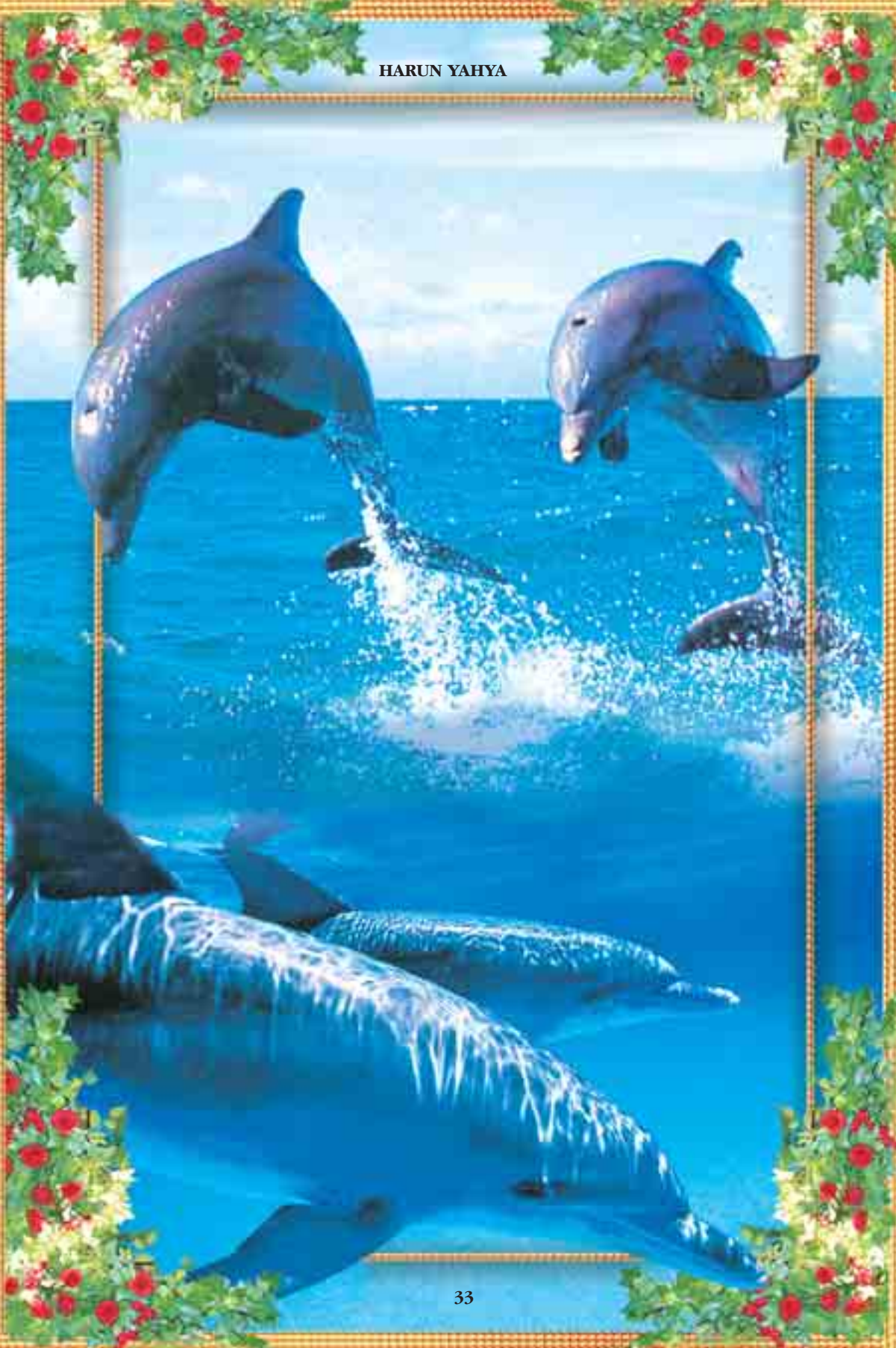

**A DEFINITIVE REPLY
TO EVOLUTIONIST
PROPAGANDA**

The perfect sonar system in dolphins inspired many scientists and led them to make use of this system in marine technology. ASDIC, the first active sonar technology invented in World War II, was able to detect and track a submerged submarine at about 2,000 yards in good conditions. The sonar system, which humans only started to use in the twentieth century, has been used by dolphins for millions of years. All these perfect designs in nature are evidence for God's matchless artistry in creation.

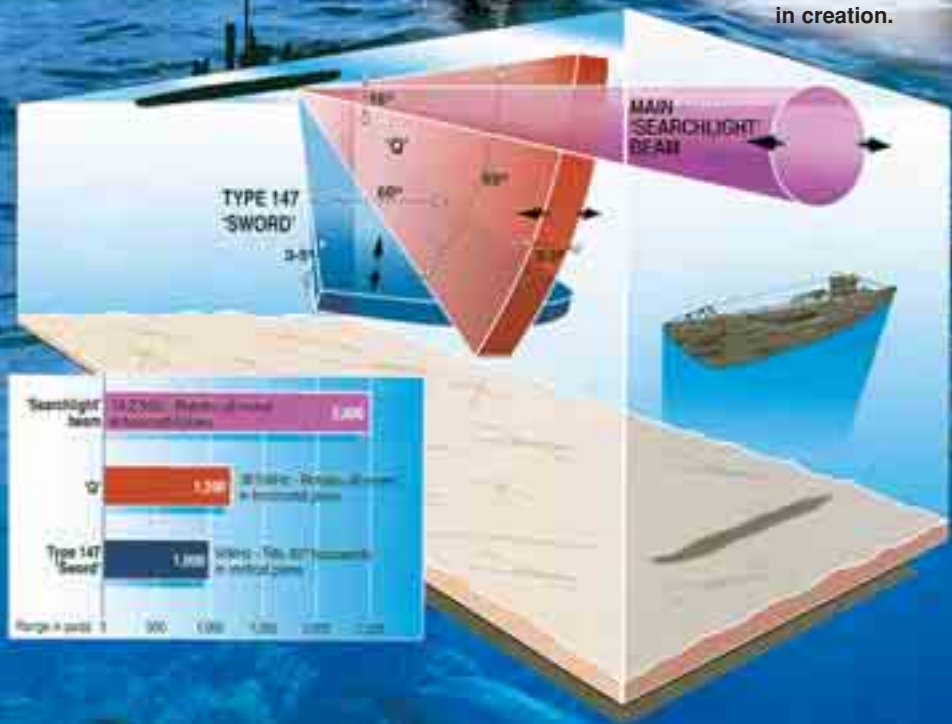

fact than a computer, is a miracle of engineering. To maintain that such an organ emerged by mutations—which evolution depends on—is just as illogical as maintaining that a computer could emerge from the soil as a result of natural phenomena such as wind and rain. No rational person would obviously ever believe such a claim. Yet National Geographic TV glosses over this complex organ during its account of dolphin sonar by calling it "a product of evolution," without offering the slightest evidence.

Another creature whose complex design leaves the theory of evolution floundering is the angelfish. Thanks to its flat body, this animal buries itself in the sand to wait for its prey, and keeps a look-out with two eyes which protrude like periscopes. One of the creature's most astonishing aspects is that it can also detect the approach of prey thanks to an organ which senses electrical signals. When the moment comes, it suddenly lunges out of its hiding place and swallows its prey in a single gulp.

National Geographic TV employed the expression "it developed a sixth sense" during its description of this sense possessed by the creature. This sensory system contains a most complex design: the animal possesses an organ that perceives electrical impulses, nerves which carry the signals received by that organ, and, most important of all, a brain capable of transforming these signals into a meaningful map. Highly effective connections transmit the signals between the nerve cells. These connections have been designed to prevent the signals from being lost or diminished in any way. In short, there is a very detailed design and organization in the sensory system. Since even a simple ammeter for measuring electric currents requires a specific design, it is clear that this much more complex sensory system was also intelligently designed.

After describing all these complex systems, National Geographic TV claimed that they all emerged "by evolution," without feeling the need to offer any evidence for this. Yet again, this shows how dogmatically devoted National Geographic TV is to the theory of evolution. It feels no need to test the foundations of the

A DEFINITIVE REPLY
TO EVOLUTIONIST
PROPAGANDA



theory. On the contrary, it seeks to account for the whole of nature in the light of the theory after having swallowed it verbatim.

Nor do the descriptions of some creatures in the program as "ruthless killers" actually reflect the truth. This expression is employed to impose the Darwinist dogma that there is a ruthless struggle for survival in nature and that living things are aggressive, selfish, and ruthless. Yet, the hunting that goes on among living things is not "ruthless killing." Animals kill only for food or self-defense. The method they employ is usually the swiftest, and thus the method that inflicts the least suffering. (For instance, a lion kills its prey by biting its throat.)

Conclusion

The magnificent hunting mechanisms and camouflage skills in living things cannot have come about by evolution. The complex design in animals and all other organisms can only be accounted for by intelligent design. National Geographic TV merely repeats Darwinist shibboleths as it describes natural phenomena. If the channel really wants to defend the theory of evolution, it must account for the origin of complex organs in evolutionary terms. Indeed, the reason why it makes do with offering accounts full of Darwinist slogans is that it is impossible to offer such an explanation.

1. "Spotting Mines With Dolphins Sonar", <http://sciencenow.sciencemag.org/cgi/content/full/1998/1016/2>

TALL TALES FROM THE NATIONAL GEOGRAPHIC CHANNEL



The documentary *Humans: Who Are We?*, one of the documentaries being broadcast on the National Geographic Channel (NGC), consists of the best-known scenarios of the myth of evolution. The scientific errors and deceptions in the documentary are explained below.

The NGC's Contradictions and the Lamarckian View of Evolution

In the documentary on the NGC, there is first of all an address by the anthropologist Ian Tattersall. Among his first statements is the idea, "Human evolution did not happen as the result of needs, it was entirely coincidental." Yet the needs which might have caused ape-men to evolve into human beings are then described several times in the minutes which follow. This is one of the most obvious contradictions in the whole program.

Actually, this is a contradiction experienced by many evolutionists, not just the NGC or Ian Tattersall. In order to shed more light on this subject, let us summarize the difference between the concepts of "evolution as a response to need" and "evolution as the result of chance alone" (even though both are in fact unscientific fairy tales).

Before Darwin, another important figure put forward an evolutionary model on the subject of the origin of living things: the French biologist Jean-Baptiste Lamarck. Lamarck's claim was rather different from the contemporary evolutionist view. In his opinion, requirements or needs gave rise to their own organs. Let us illustrate Lamarckism with the example of the giraffe's neck. According to this theory, the necks of the first giraffes were the same length as those of deer or gazelles. However, giraffes experiencing food shortages wanted to be able to reach the rich sources of food in the upper levels of trees. A need was thus born. As a result of that need, the

**A DEFINITIVE REPLY
TO EVOLUTIONIST
PROPAGANDA**

necks of giraffes wishing to reach up into the tops of trees grew longer.

Lamarckism based this claim on the thesis of "inheritance of acquired traits." In other words, the giraffe which had tried to reach up to trees' highest levels throughout its life should be able to hand this characteristic on to its young. Yet, with the discovery of the laws of genetics, it was seen that acquired traits could not actually be inherited at all.

As a result, Lamarckism had been invalidated by science by the beginning of the twentieth century. Yet, evolutionists continued to put forward Lamarckian views between the lines. While fiercely criticizing Lamarckism on the one hand, their scenarios regarding the origins of living things still bore powerful traces of it. The myth of front legs' remaining free in order to make tools, making man a bipedal (two-footed) creature, the claim that Neanderthal man



FALSE

evolved in order to be able to live in cold climates, as put forward by the NGC, and that *Australopithecus* evolved in order to adapt to its environment as the thick forests thinned out—all of these rest on the assumption of evolution out of need.

The reason why evolutionists employ Lamarckian expressions, on the one hand, while fiercely criticizing the thesis, on the other, is this: According to the theory of evolution, in order for a monkey to be able to stand on two legs, for instance, it needs to be exposed to mutations that will bring about such a sensitive change in its skeleton, and which furthermore will not cause it any damage. This is in any case a scenario that cannot possibly happen. It would require a chance mutation to come about at just the very time when the living thing in question has need of it, and this would have to occur many times in individuals of the same species, bringing about a little more development each time. The impossibility of this scenario just reinforces the absurdity of the whole concept of evolution.

On the surface, evolutionists refuse to say, "there was evolution out of need," but underneath, they actually support that idea.

Australopithecus was a Species of Ape, and was not Bipedal

According to the NGC, the species known as *Australopithecus* was the ancestor of the first man to walk upright. Yet that claim is not correct. All of the *Australopithecus* species are extinct apes that resemble the apes of today. Their cranial capacities are the same or smaller than those of the chimpanzees of our day. There are projecting parts in their hands and feet that they used to climb trees, just like in today's chimpanzees, and their feet are built for grasping to hold onto branches. *Australopithecus* specimens are short (130 cm, maximum) and, just as in modern apes, the males are much bigger than the females. Many other characteristics—such as the details in their skulls, the closeness of their eyes, their sharp molar teeth, their

A DEFINITIVE REPLY
TO EVOLUTIONIST
PROPAGANDA

mandibular structure, their long arms, and their short legs—constitute evidence that these creatures were no different from today's apes.

NGC's claim that *Australopithecus* walked upright is a view that has been held by paleoanthropologists like Richard Leakey and Donald C. Johanson for decades. Yet many scientists who have carried out a great deal of research on the skeletal structures of *Australopithecus* have proved the invalidity of that argument. Extensive research done on various *Australopithecus* specimens by two world-renowned anatomists from England and the USA, Lord Solly Zuckerman and Prof. Charles Oxnard, showed that these creatures did not walk upright in the human manner, and had exactly the same movements as modern apes. Having studied the bones of these fossils for a period of 15 years thanks to grants from the British government, Lord Zuckerman and his team of five specialists reached the conclusion that *Australopithecus* was only an ordinary species of ape, and was definitely not bipedal—this even though Zuckerman is an evolutionist himself.¹ Correspondingly, Charles E. Oxnard, who is another evolutionary anatomist famous for his research on the subject, also likened the skeletal structure of *Australopithecus* to that of modern orangutans.²

Probably the most important study demonstrating that *Australopithecus* could not have been bipedal came in 1994 from the research anatomist Fred Spoor and his team at the University of Liverpool, England. This group conducted studies in the inner ear of fossilized *Australopithecus* specimens. In the inner ears of human beings and other complex living beings, there is an organ named the "cochlea" that determines the position of the body in relation to the ground. The function of this organ, which maintains balance in human beings, is



Right: Donald Johanson
Left: Richard Leakey



Many characteristics of the australopithecines' head, such as a low forehead, a large eyebrow ridge, a flat nose, and a jutting jaw constitute evidence that these creatures were no different from today's apes.

The small brain size of *Australopithecus* is also an indication of the fact that they were apes.

low, flattened forehead

low brow ridge



Australopithecus brain
(450-500 cc in volume)



Human brain
(1400 cc in volume)



HUMAN AND APE FEET

The ape's big toe sticks out at an angle and is used for grasping. In humans, the big toe is aligned with the others.



HUMAN NECK

The human head is balanced on the top of the backbone.



APE NECK

The backbone of a ape meets its head at an angle.



HUMAN AND APE HIPS

Humans have a broad, short pelvis for upright walking; apes have a long, narrow pelvis.

Extensive research done on various *Australopithecus* specimens has shown that these creatures did not walk upright in human manner. In fact, it is impossible for them to have done so, because they had the anatomy of apes, which enabled them only to walk on all fours. The human skeleton, on the other hand, is designed to walk upright.

A DEFINITIVE REPLY
TO EVOLUTIONIST
PROPAGANDA

the same as the "gyroscope," which maintains correct flight attitude in airplanes. Fred Spoor investigated the involuntary balance mechanism found in this "snail-shell" like organ, and his findings showed conclusively that *Australopithecus* was quadrupedal (four legged).³

This means *Australopithecus* is an extinct ape species and has no relation with human beings.

That *Australopithecus* cannot be counted an ancestor of man has recently been accepted by evolutionist sources. The famous French popular-science magazine, *Science et Vie*, made the subject the cover of its May 1999 issue. Under the headline "Adieu Lucy" ("Goodbye, Lucy"—Lucy being the most important fossil example of the species *Australopithecus afarensis*), the magazine reported that apes of the species *Australopithecus* would have to be removed from the human family tree. In this article, based on the discovery of another *Australopithecus* fossil known simply as St W573, the following sentences appear:

A new theory states that the genus *Australopithecus* is not the root of



"GOODBYE, LUCY"

Scientific discoveries have revealed evolutionist assumptions regarding "Lucy," once considered the most important example of the *Australopithecus* genus, as completely unfounded.

Actually, each new discovery in paleontology causes evolutionists to redesign their tree of life, which is nothing but a figment of their imagination.

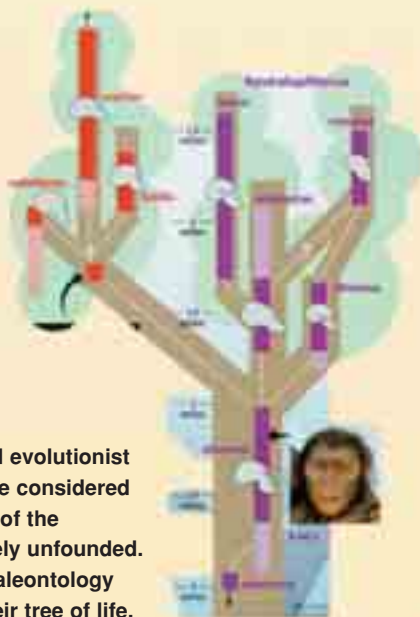

the human race... The results arrived at by the only woman authorized to examine St W573 are different from the normal theories regarding mankind's ancestors: this destroys the hominid family tree. Large primates, considered the ancestors of man, have been removed from the equation of this family tree... *Australopithecus* and *Homo* [human] species do not appear on the same branch. Man's direct ancestors are still waiting to be discovered.⁴

Another important discovery concerning *Australopithecus* is the realization that this creature's hands were used for walking, just like those of present-day apes. Apes employ a four-legged mode of walking in which they lean on the knuckles of their fingers. Known as "knuckle walking," this is one of the major structural differences



There is a big anatomical difference between human and ape feet. Apes have longer toes and a divergent great toe, and lack the arch that gives spring to the human stride.

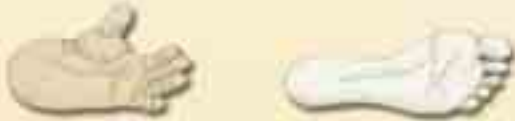

Humans hold the upper body erect and walk upright on two feet. This is a very special form of locomotion. Apes, on the other hand, are knuckle-walkers, who walk with the upper body bent forward, using the arms to provide extra support. This is one of the unbridgeable anatomical gaps between men and apes which also invalidate the fiction of human evolution.

As may be seen from these pictures, the ape hand lacks the long and mobile thumb, which is an essential feature of human hand. Without the current structure of the thumb, we would not be able to do many of the things that we do now.



between apes and men. The skeletal studies performed in 2000 on Lucy by two evolutionist scientists called B. G. Richmond and D. S. Strait, resulted in a conclusion that astonished the two evolutionists: Lucy's hand possessed a four-legged "knuckle walking structure," just like those of the apes of today. Strait's comment in an interview regarding this discovery, the details of which were covered by the journal *Nature*, is striking: "I walked over to the cabinet, pulled out Lucy, and—shazam!—she had the morphology that was classic for knuckle walkers."⁵

Homo erectus was a Human Race, not an Ape-Man

In the NGC documentary *Homo erectus* is portrayed as a half-ape, half-man creature which walked upright and tried to speak by making peculiar noises. The fact is, however, that *Homo erectus* was a human race, with no ape characteristics at all.

There is no difference between the *Homo erectus* skeleton and that of modern man. The primary reason for evolutionists' defining *Homo erectus* as "primitive" is the cranial capacity of its skull (900-1,100 cc), which is smaller than the average modern man, and its thick eyebrow projections. However, there are many people living today in the world who have the same cranial capacity as *Homo erectus* (pygmies, for instance) and other races have protruding eyebrows (Native Australians, for instance).

It is a commonly agreed-upon fact that differences in cranial capacity do not necessarily denote differences in intelligence or abilities. Intelligence depends on the internal organization of the brain, rather than on its volume.⁶

The fossils that have made *Homo erectus* known to the entire world are those of Peking man and Java man in Asia. However, in time it was realized that these two fossils are not reliable. Peking Man consists of some elements made of plaster whose originals have been lost, and Java Man is "composed" of a skull fragment plus a

As seen in this picture, there is no difference between the postcranial skeleton of modern man and that of *Homo erectus*. It is now an acknowledged fact in the scientific community that *Homo erectus* is a superfluous taxon, and that fossils assigned to the *Homo erectus* class are actually not so different from *Homo sapiens* as to be considered a different species. This thesis can be summarized as "*Homo erectus* is not a different species from *Homo sapiens*, but rather a race within *Homo sapiens*."



Homo erectus



Homo sapiens



Homo erectus



Homo sapiens

A DEFINITIVE REPLY
TO EVOLUTIONIST
PROPAGANDA

pelvic bone that was found meters away from it with no indication that these belonged to the same creature. This is why the *Homo erectus* fossils found in Africa have gained such increasing importance.

The most famous of the *Homo erectus* specimens found in Africa is the fossil of the "Turkana Boy," which was found near Lake Turkana in Kenya. It is confirmed that the fossil was that of a 12-year-old boy, who would have been 1.83 meters tall in adolescence. The upright skeletal structure of the fossil is no different from that of modern man. The American paleoanthropologist Alan Walker said that he doubted that "the average pathologist could tell the difference between the fossil skeleton and that of a modern human." Concerning the skull, Walker wrote that he laughed when he saw it because "it looked so much like a



Richard Leakey (left) and Alan Walker, who studied the Turkana Boy fossil—the most complete known specimen of *Homo erectus*—concluded that it belonged to a 12-year-old boy 1.6 meters tall. The interesting thing is that there is no major difference between this 1.6 million-year-old fossil and people of our day. This situation reveals once again that *Homo erectus* was a genuine human race, with no "primitive" features.

Neanderthal."⁷ Since Neanderthals are a modern human race, *Homo erectus* is also a modern human race.

Even the evolutionist Richard Leakey states that the differences between *Homo erectus* and modern man are no more than racial variance:

One would also see differences in the shape of the skull, in the degree of protrusion of the face, the robustness of the brows and so on. These differences are probably no more pronounced than we see today between the separate geographical races of modern humans. Such biological variation arises when populations are geographically separated from each other for significant lengths of time.⁸

Professor William Laughlin from the University of Connecticut made extensive anatomical examinations of Inuits and the people living on the Aleutian islands, and noticed that these people were extraordinarily similar to *Homo erectus*. The conclusion Laughlin arrived at was that all these distinct races were in fact different races of *Homo sapiens* (modern man):

When we consider the vast differences that exist between remote groups such as Eskimos and Bushmen, who are known to belong to the single species of *Homo sapiens*, it seems justifiable to conclude that *Sinanthropus* [an erectus specimen] belongs within this same diverse species.⁹

There is a huge gap between *Homo erectus*, a human race, and the apes that preceded *Homo erectus* in the "human evolution" scenario (*Australopithecus*, *Homo Habilis*, and *Homo rudolfensis*). This means that the first men appeared in the fossil record suddenly and without any prior evolutionary history.

NGC Fairy Tales Appropriate for Bedtime Programs

The scientists expressing their views on NGC told the viewer stories, relying on their imaginations instead of scientific findings. Almost the entire length of the documentary consisted of such story-

telling. The most striking example of this appeared in the section about *Homo erectus*' power of speech. People enjoying the status of scientists gave their views, in all seriousness, regarding what members of the *Homo erectus* species talked about amongst themselves. According to the anthropologist Dr. Steven Mithen, when *Homo erectus* spoke, they engaged in gossip! Another evolutionist scientist claimed that rather than gossiping, they talked about serving food!

Neither was this the limit of the stories related on NGC. These scientists were also somehow aware of a great many more details, such as what one migrating ape-man thought, and the fixed-thoughts possessed by yet another one. The odd thing is that these Darwinist mental gymnastics, devoid of any scientific foundations, were portrayed to the viewer as scientific fact.

The NGC's Visual Evolutionist Propaganda

Throughout the documentary on NGC, images of half-ape, half-man creatures hunting on the African savannah, eating, and migrating were shown. Those who imagined the NGC to be a scientific institution would have been deceived into thinking that these creatures were based on scientific evidence. The fact is, however, that just like the information provided, these images had been prepared solely on the basis of evolutionists' imaginations and the abilities of various artists.

Reconstructions are one of evolutionists' most important propaganda tools. The ape-man models and drawings seen in such documentaries as this, and in evolutionist magazines and newspapers, are termed reconstructions. These are totally unscientific, and in no way reflect the truth, because it is impossible to obtain any information about a living thing's soft tissues on the basis of fossils. Reconstructions based on bone remains can only reveal the most general characteristics of the creature, since the really distinctive morphological features of any animal are soft tissues, which quickly

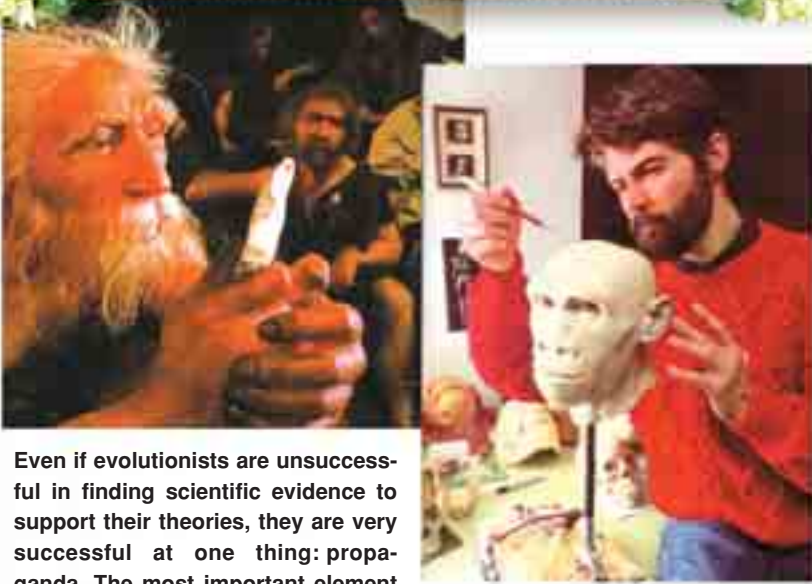

Even if evolutionists are unsuccessful in finding scientific evidence to support their theories, they are very successful at one thing: propaganda. The most important element of this propaganda is the practice of creating false designs known as "reconstructions."

vanish after death. Therefore, due to the speculative nature of the interpretation of the soft tissues, the reconstructed drawings or models become totally dependent on the imagination of the person producing them. Earnst A. Hooten from Harvard University explains the situation like this:

To attempt to restore the soft parts is an even more hazardous undertaking. The lips, the eyes, the ears, and the nasal tip leave no clues on the underlying bony parts. You can with equal facility model on a Neanderthaloid skull the features of a chimpanzee or the lineaments of a philosopher. These alleged restorations of ancient types of man have very little if any scientific value and are likely only to mislead the public ... So put not your trust in reconstructions.¹⁰

In the NGC documentary, all kinds of details, such as living things' hair, eyes, lips, the expressions in their eyes, and the shape of their eyebrows, could be seen. In fact, since evolutionists are so caught up by their evolutionary fantasies as to debate what these

imaginary creatures might have talked about, it comes as no surprise that they should also come up with models and drawings of them. This is not science, however. It could only be a part of a science fiction film. Evolutionists are not behaving like scientists. Like fortune-tellers engaging in prophecies, they produce scenarios about the past and future based on no evidence whatsoever.

Conclusion

NGC's documentary, which describes the so-called evolution of man, offering no evidence but supplying details which can never be known, is of absolutely no scientific value. The only place for this documentary is in a science fiction movie or a screenwriter's fantasies about human history. The way that the NGC broadcasts scenarios, which not even children could possibly find convincing, under the guise of science casts a shadow over the institution's credibility.

1 - Solly Zuckerman, *Beyond The Ivory Tower*, New York: Toplinger Publications, 1970, p. 75-94

2- Charles E. Oxnard, "The Place of Australopithecines in Human Evolution: Grounds for Doubt," *Nature*, vol. 258, p. 389

3- Fred Spoor, Bernard Wood, Frans Zonneveld, "Implication of Early Hominid Labyrinthine Morphology for Evolution of Human Bipedal Locomotion," *Nature*, vol. 369, 23 June 1994, p. 645-648.

4- Isabelle Bourdial, "Adieu Lucy," *Science et Vie*, May 1999, no. 980, p. 52-62

5- Stokstad, E., "Hominid ancestors may have knuckle walked," *Science* 287(5461):2131, 2000

6- Marvin Lubenow, *Bones of Contention*, Grand Rapids, Baker, 1992, p. 83

7- Boyce Rensberger, *The Washington Post*, 19 November 1984

8- Richard Leakey, *The Making of Mankind*, London: Sphere Books, 1981, p. 62

9- Marvin Lubenow, *Bones of Contention*, Grand Rapids, Baker, 1992. p. 136

10 - Earnest A. Hooton, *Up From The Ape*, New York: McMillan, 1931, p. 332

**To Him belongs the dominion of
the heavens and the earth: It is He
Who gives life and death; and He
has Power over all things.**

(Qur'an, 57: 2)

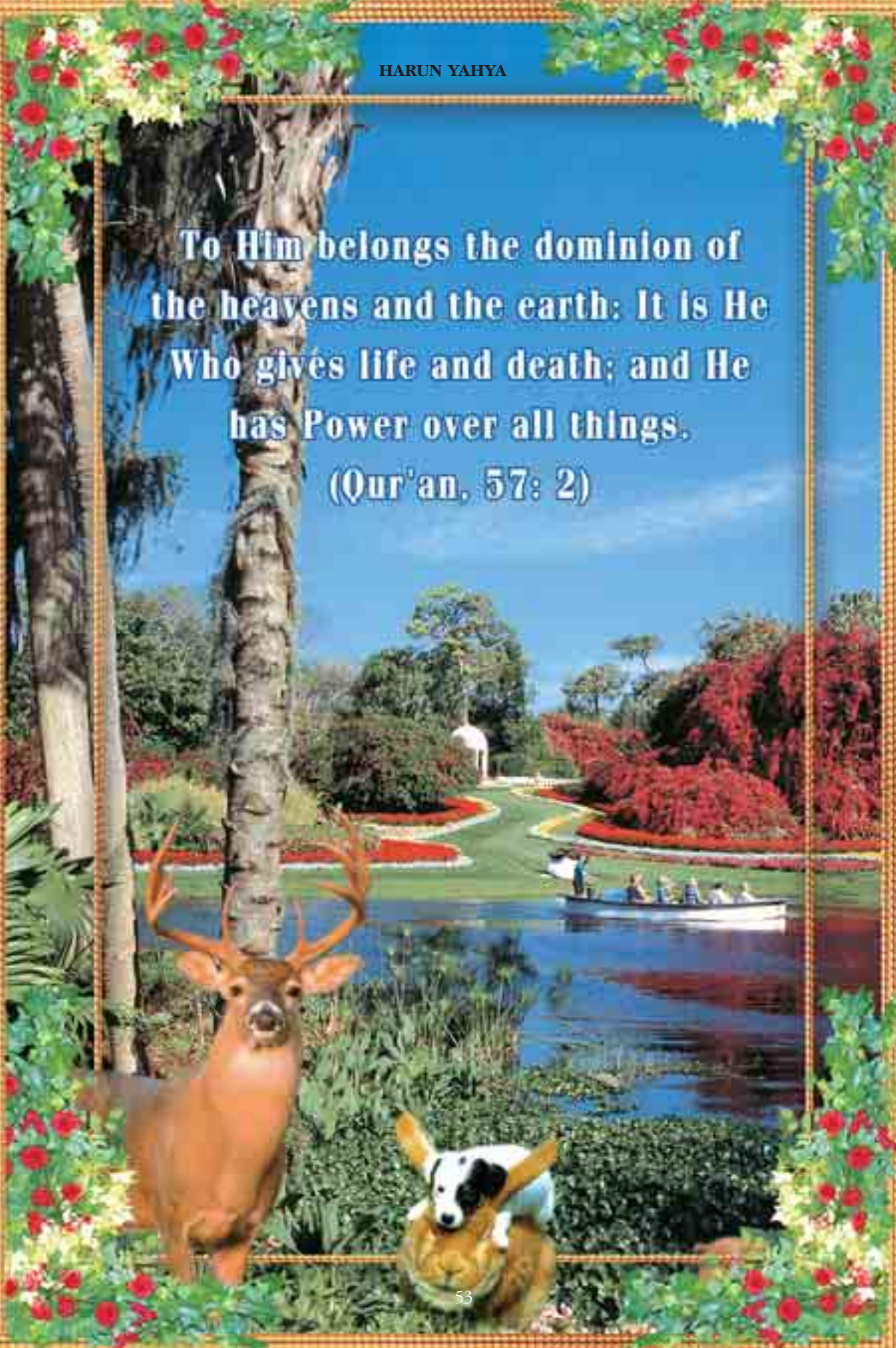



**TALES OF TRANSFORMATION
FROM NATIONAL GEOGRAPHIC
TELEVISION**



National Geographic TV recently broadcast a documentary called *Evolution – The Great Transformations*. It mainly concentrated on the origin of whales, and devoted considerable space to evolutionist claims regarding their transition from the sea to the land, together with comments concerning at which stages such transitions might have come about. National Geographic TV's favored solution to the question of the origin of whales was an interesting one: It was proposed that dogs surviving by eating corpses on the sea shore decided to live in the sea in order to find a better supply of food. Over time their front legs turned into fins and they lost their back legs altogether, thus giving rise to whales. In these imaginary scenarios dreamed up by National Geographic TV accompanied by computer reconstructions, living things with completely different physical structures easily turned into other creatures: dogs into whales, for instance, or fish into land-dwellers. Yet what was related was totally based on imagination, and possessed no scientific significance or value. The drawings produced consisted of nothing more than the scenarios demanded by the Darwinist theory, which is entirely lacking in any scientific proof. In this article, we shall be explaining how the great transformations discussed on National Geographic TV never actually happened.

A Whale Story for the Very Young

The origin of whales, and of sea mammals in general, is a very important question from the point of view of the theory of evolution. The theory maintains that sea-dwelling creatures moved onto the land, where mammals evolved. This leads to an important question regarding the existence of marine mammals, one which is difficult to answer: If mammals evolved on land, how and why did they return to the sea?

Charles Darwin gave considerable thought to this question,

A DEFINITIVE REPLY
TO EVOLUTIONIST
PROPAGANDA

which represented a serious dilemma for his theory, but failed to come up with a conclusion. On this point, which truly deadlocked his theory, he was forced to suggest a none-too-convincing ancestor. The animal Darwin suggested as the ancestor of whales was the bear. He said, "I can see no difficulty in a race of bears being rendered, by natural selection, more and more aquatic in their structure and habits, with larger and larger mouths, till a creature was produced as monstrous as a whale."¹

While applauding Darwin's imagination, evolutionists are now of the view that whales must have had some other ancestor. The latest creature suggested to fill this vacancy is a species of dog.

National Geographic magazine embarked on a campaign of whale propaganda in its November 2001 edition, publishing this inconsis-

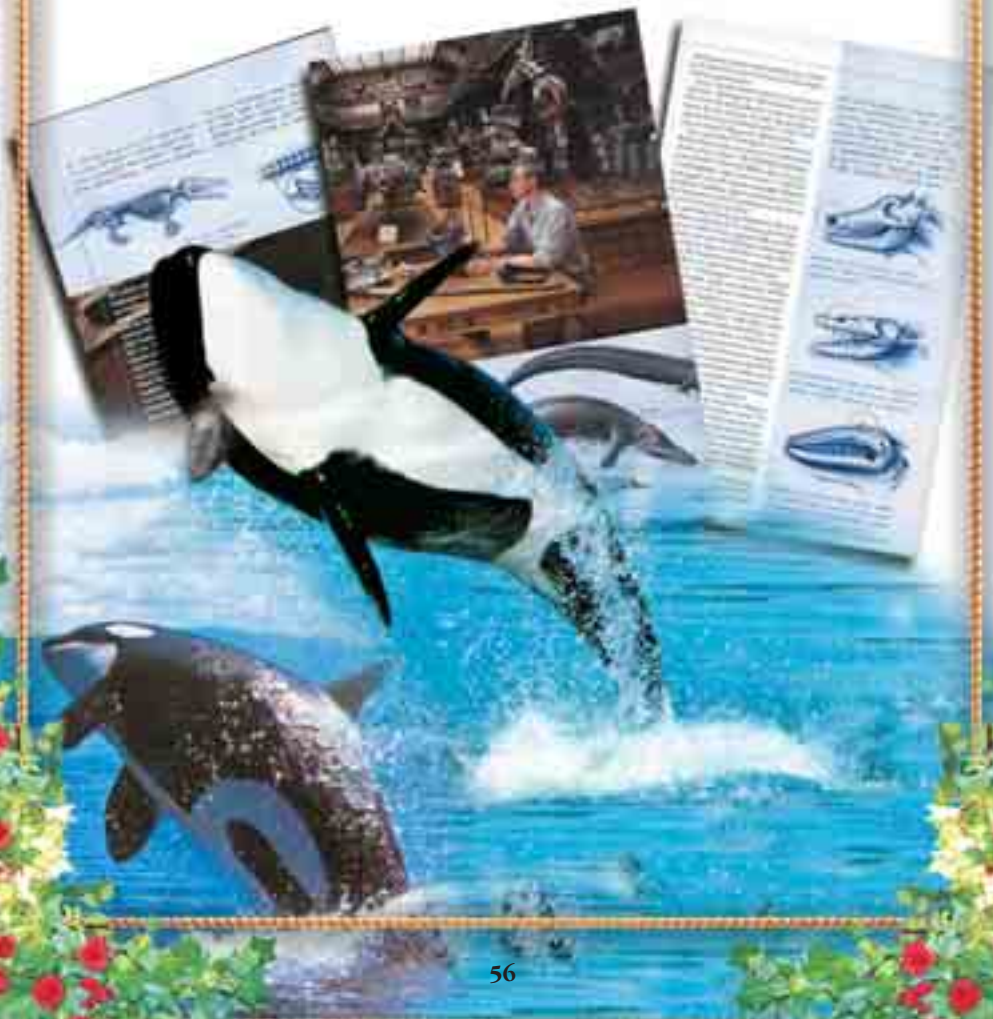

tent claim in a 14-page article, complete with illustrations. We published a detailed response to this "whale evolution" claim, revealing all its contradictions and inconsistencies, in a paper on our website, www.harunyahya.com. The whale story on the TV screens went no further than the scenarios in the magazine, and made no new claims.

For that reason, we shall not be going into scientific detail regarding those points, which invalidate these claims about the whale, recommending instead that our readers to turn to our original article. "A Whale Fantasy from *National Geographic*":

http://www.harunyahya.com/70national_geographic_sci29.php

The Problems with the Transition from Sea to Land and the *Acanthostega* Error

One of the so-called evolutionary transformations discussed on National Geographic TV had to do with the theory of the transition from the sea to the land. This theory suggests that fish emerged in the sea by means of evolution and moved onto the land some 370 million years ago. No scientific evidence can be produced to show how fish, whose organs and systems were completely suited to allowing them to live in the sea, could have survived on land, nor how they could have turned into other species. Instead of scientifically examining one of the fundamental dogmas of Darwinism, National Geographic TV glosses it over with a fairy-tale account.

The scale of the deception represented by this claim, so blindly defended by National Geographic TV, becomes even clearer upon examination of the fossil record.

According to Darwin, species evolved from a common ancestor, and this evolutionary process must have happened in stages. In the event of one species' evolving from another, there should be a great many intermediate forms between the two. The natural conclusion from this would be that the geological strata should be full of count-

less fossils displaying such intermediate characteristics. Yet, the situation in the fossil record is actually the exact opposite. Fossils appear to be divided into very clear categories, and species appear to have possessed their characteristic traits from the very beginning. New categories of living things always appear suddenly in the fossil record.

The efforts of evolutionist paleontologists all over the world have been fruitless, and the long-sought-for missing links have never been found. This demonstrates very clearly why no process such as evolution ever happened. National Geographic TV, on the other hand, covers up the dilemma that fossils pose for the theory and portrays the transition from sea to land as if it had actually happened. The TV channel refuses to accept the collapse of Darwinism, and therefore clings to the extinct species known as *Acanthostega*.

Acanthostega and What it Brings to Mind

Acanthostega is a sea creature with gills. Its age is estimated at some 360 million years. Jenny Clack, a paleontologist from Cambridge University, maintains that this fossil possesses a hand, and that on this hand there are eight fingers, for which reason it is an intermediate form between fish and tetrapods (four-footed land vertebrates). Taking this fossil as their starting point, evolutionists claim that instead of fish developing feet after moving onto the land, they first developed feet and then made that transition. Yet this claim is inconsistent. First of all, despite being an evolutionist, Clack clearly states that she does not know whether *Acanthostega*

made the transition to the land or not. It is an error to regard a marine-dwelling creature with certain bone-like structures in its fins as a form that brought about the transition from sea to land. The fact that

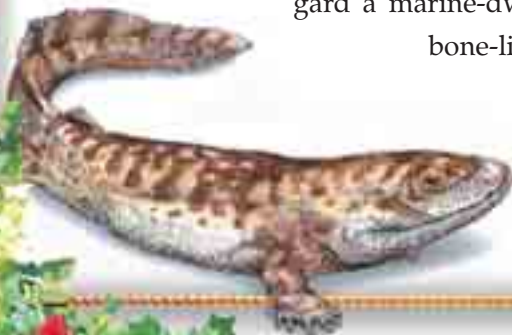

Acanthostega

When they only had fossils of *Coelacanth*s, evolutionist paleontologists put forward a number of Darwinist assumptions regarding them; however, when living examples were found, all these assumptions were shattered.



evolutionists are making this error shows how quickly they have forgotten their mistakes over the *Coelacanth*, which was discovered to be living up until 65 years ago.

Up until the end of 1930s, evolutionists portrayed the *Coelacanth* as an intermediate form. It was thought that the bones in the fins of this 200-million-year-old fossil turned into feet, which carried the creature when it moved onto the land. In 1938, however, they learnt to their great surprise that *Coelacanth* was still living. On close examination, it was revealed that these fish caught by fishermen off the coast of Madagascar had undergone no changes at all in the last 200 million years. Furthermore, the organ which evolutionists had believed to be a primitive lung turned out to be nothing but a fat-filled swimbladder. Moreover, a great many more *Coelacanth*s were caught shortly afterwards, and evolutionists had to abandon forever the claim that the creature represented an intermediate form.

As can be seen from the *Coelacanth* example, as well as that of *Acanthostega*, marine creatures with bone-like structures are portrayed as intermediate forms, not because they might have been able to live on land, but because of evolutionists' prejudices.

Obstacles to the Transition from Water to Land

The profound physiological differences between land and marine mammals can be divided into five basic categories:

1. Weight-bearing: Sea-dwelling creatures have no problem in bearing their own weight in the sea. However, most land-dwelling creatures consume 40% of their energy just in carrying their bodies around. Creatures making the transition from water to land would at the same time have had to develop new muscular and skeletal systems (!) to meet this energy need, and this could not have come about by chance mutations.

2. Heat Retention: On land, the temperature can change quickly, and fluctuates over a wide range. Land-dwelling creatures possess a physical mechanism that can withstand such great temperature changes. However, in the sea, the temperature changes slowly and within a narrower range. A living organism with a body system reg-



God created every living
[creature] from water. Some
of them go on their bellies,
some of them on two legs,
and some on four.

ulated according to the constant temperature of the sea would need to acquire a protective system to ensure minimum harm from the temperature changes on land. It is preposterous to claim that fish acquired such a system by random mutations as soon as they stepped onto land.

3. Water: Essential to metabolism, water needs to be used economically due to its relative scarcity on land. For instance, the skin has to be able to permit a certain amount of water loss, while also preventing excessive evaporation. That is why land-dwelling creatures experience thirst, something sea-dwelling creatures do not do. For this reason, the skin of sea-dwelling animals is not suitable for a non-aquatic habitat.

4. Kidneys: Sea-dwelling organisms discharge waste materials, especially ammonia, by means of their aquatic environment. On land, water has to be used economically. This is why these living beings have a kidney system.



God creates whatever
He wills. God has power
over all things.
(Qur'an, 24: 45)

Thanks to the kidneys, ammonia is stored by being converted into urea and the minimum amount of water is used during its excretion. In addition, new systems are needed to provide for the kidney's functioning. In short, in order for the passage from water to land to have occurred, living things without a kidney would have had to develop a kidney system all at once.

5. Respiratory system: Fish "breathe" by taking in oxygen dissolved in water, which they pass through their gills. They cannot live more than a few minutes out of water. In order to survive on land, they would have to acquire a perfect lung system all of a sudden.

It is most certainly impossible that all of these dramatic physiological changes could have happened in the same organism at the same time, and all by chance.

National Geographic TV is Reluctant to Tell the Truth About the Cambrian Explosion

One section at the beginning of the documentary "Evolution – The Great Transformations" is devoted to the Cambrian Period. This is when organisms with complex physical structures are first encountered in the fossil record. The most basic categories of living things are known as "phyla." And it is most interesting that just about all the phyla now living should have emerged in the Cambrian Period. Before that time, there were only a few phyla, whereas the fossil record shows the number of phyla emerging during the Cambrian to be around 100. This enormous leap in the variety of living things at that time is so impressive that it has been given the name "Cambrian Explosion" in the scientific literature. The Cambrian Explosion represents one of the most serious dilemmas facing the theory of evolution. The National Geographic TV channel is reluctant to make the facts regarding that period clear, offering an obscure account instead.

The facts concealed by National Geographic TV are expressed by the well-known evolutionist Richard Monastersky in these terms:

A half-billion years ago, . . . the remarkably complex forms of animals that we see today suddenly appeared. This moment, right at the start of Earth's Cambrian Period, some 550 million years ago, marks the evolutionary explosion that filled the seas with the world's first complex creatures.²

The illustration and the fossils seen here include some of the living things with complex structures from the Cambrian age. The emergence of such different creatures with no preceding ancestors completely invalidates Darwinist theory.



A DEFINITIVE REPLY
TO EVOLUTIONIST
PROPAGANDA

Jan Bergström, a paleontologist who studied the early Cambrian deposits also says:

The large animal phyla of today were present already in the early Cambrian and they were as distinct from each other then as they are today.³

No similar organism which evolutionists might be able to put forward as the "ancestor" of the living things which emerged in the Cambrian Explosion exists. The creatures of the Cambrian Explosion came into being instantaneously, with all their features perfectly formed. This, of course, indicates that creation lies at the root of the Cambrian Explosion.

Another aspect of the Cambrian Period explosion, which undermines evolution, is that there are considerably fewer phyla today than there were during the Cambrian. According to the theory of evolution, there should have been an increase over time in the number of categories of living things. Yet, the fossil record demonstrates the exact opposite. The number of phyla existing today is less than half the number that emerged during the Cambrian; the others have gradually become extinct.

One of the most important critics of Darwinism in the world today is the University of California Berkeley professor Phillip E. Johnson, who openly reveals the contradiction between these facts and Darwinism:

Darwinian theory predicts a "cone of increasing diversity," as the first living organism, or first animal species, gradually and continually diversified to create the higher levels of taxonomic order. The animal fossil record more resembles such a cone turned upside down, with the phyla present at the start and thereafter decreasing.⁴

There can be only one reason for the indirect way this is dealt with in the documentary screened by National Geographic: This explosion shows that life on Earth did not come about by chance, but emerged suddenly and perfectly formed—in other words, that it was created.

National Geographic TV's DNA Error

In a later part of the National Geographic TV documentary, another major error appears, when it is claimed that genetic similarities account for so-called evolutionary transformations. We are told how similar organs in organisms from different species are controlled by similar genes, and it is then suggested that small changes in the DNA which controls such similarities between organisms can give rise to new species. Yet, this claim is a total violation of all experiments and observations in the field of genetics: Chance alterations in the genes (mutations) have never been seen to develop living things or to increase their genetic information. For nearly a century, scientists studying the inheritance mechanisms by which physical features are encoded and passed on from generation to generation have obtained findings revealing that DNA is a most complex design directed by exceptional control mechanisms.

Even a general overview of the structure of DNA will be sufficient to demonstrate that the claims of the Darwinists go no further than fantasy, and that these need to be distinguished from the science of genetics.

DNA: The Molecule Which Refutes Evolution

The DNA molecule is found in structures that are specially packaged in the form of chromosomes.



**A DEFINITIVE REPLY
TO EVOLUTIONIST
PROPAGANDA**

The molecule known as DNA, which is found in the nucleus of each of the 100 trillion cells in our bodies, contains the complete blueprint for the construction of the human body. If we were to write down the information coded in DNA,



then we would have to compile a giant library consisting of 900 volumes of 500 pages each. But the information this enormous library would hold is encoded inside the DNA molecules in the cell nucleus, which is far smaller than the 1/100th-of-a-millimeter-long cell itself.

In the cell nucleus, far too small to be seen by the naked eye, are curled a total of 3 meters of DNA strings. These spiral DNA strings bound up in the chromosomes are divided up into the parts we know as "genes." Despite the tiny volume occupied by this packaging system, it possesses a huge information-storage capacity. It is calculated that there is enough information to fill around 1 million encyclopaedia pages in the nucleus of a single human cell.

Exceedingly complex systems allow this information to function. The functioning of the DNA molecule is of vital importance to a living thing's survival. Every stage of this functioning is controlled. Some stages in the functioning of the perfect system that is DNA are the following:

Encoding: Nucleotides are sequenced in the DNA string. There are four types of these; adenine, guanine, thymine and cytosine. Consecutively arranged, three-part nucleotide sequences are known as "codons." If we imagine the nucleotides as letters (A, T, C and G), then the codons are words (AAT, CAG, TCC, etc.).

Location: All the information describing all of a living thing's physical and biochemical structures is set out in the cell nucleus. However, cells in different structures will generally only require that part of the information for their own functioning. For that reason, the necessary information must be located within the huge information bank, which includes all the details of the body plan. This is done by means of enzymes: enzymes stand at specific points and open up the links which extend between the two spiral strings of the DNA, like a zipper. The points where the zipper begins and stops opening, are the borders of the relevant information. It is rather as if enzymes searched among the shelves of a giant library and took out the book they were looking for. This is a genuine miracle, because enzymes are nothing more than molecules made up of unconscious atoms.

Reading: After the required section of DNA has been found, the special enzymes attached to this section begin to read the nucleotides, three by three. The reading of these triplet nucleotide

strings, in which the information is encoded, is a very particular phenomenon. The enzyme, which carries out the reading process, separates the combined millions of nucleotides into the triplets. This process takes less than one second.

Translation: There are four types of nucleotides in DNA. The proteins, which will be used in the activities and development of the organism, however, emerge from amino acids, not from the nucleotides. Living things contain 20 amino acids. In essence, the language of DNA consists of four letters, but the language of proteins consists of 20. Thus, these letters are different from one another. Yet, a surprising "translation" takes place: the enzymes, which read the codons in the DNA, "understand" that this codon refers to an amino-acid, despite the fact that there are no amino acids in the codon. The nucleotide language in the DNA is translated into the amino-acid language in the protein. Unconscious enzymes thus work yet another miracle.

Repair: Cell multiplication in the development of the body is of vital importance. During this process, the DNA in the dividing cell is copied and reproduced in the new cell. During this replication, some 3.1 billion nucleotides need to be copied in exactly the same order. If just one nucleotide in a gene is missing, then the codons in the new nucleotide order will go wrong, resulting in the synthesis of totally different proteins, which may in turn result in the death of the organism. (With the missing nucleotide, all the triple-read codons will change.) There is a system in the cells which checks and repairs these mistakes (mutations). The copied nucleotide string is checked against the original, and any errors are restored to the original form. This repair process, known as "proofreading," takes place an average of 20,000 times a second in the human body.

The complex design of these systems in DNA makes the claims of genetic transformation put forward on National Geographic TV ridiculous. Random changes in DNA—mutations, in other words—damage the sensitive genetic code in living things and give rise to abnormal organs. As shown on National Geographic, embryos ex-

posed to poison or radiation are born totally abnormal. Mutation experiments over nearly a century have not been seen to add any information to organisms' DNA. This fact reveals the invalidity of the claim that organisms evolved from simple to complex forms by chance mutations.

Beyond these scientific facts, we can also see the truth of this from our experiences in our daily lives. Random changes in complex designs do not turn these into other complex designs. For instance, taking a chip out of a jet airplane's electronic circuits does not turn that plane into a helicopter.

In short, the complex structure of DNA represents a great obstacle to the theory of evolution. National Geographic TV's claim that DNA possesses a structure which can facilitate so-called evolution rests on Darwinist prejudices, not on the scientific facts.

The Same Old Scenarios from National Geographic TV

In the last part of the program, the claim is made that man and chimpanzees evolved from a common ancestor. This part relies on an account by the evolutionist paleontologist Donald Johanson, and the methods of glossing over and distortion employed in the beginning of the program once again attract one's attention.

Not a word is mentioned about recent fossil discoveries that have left the theory of evolution in tatters. The fact that National Geographic TV, which claims to be a channel of science and discovery, devotes no space to the fossil known as *Sahelanthropus tchadensis*, which has led to intense debates in the world of paleontology and which has hit evolutionist scenarios like an atom bomb, once again clearly reveals its blind devotion to Darwinism.

Another issue ignored in this section concerned the scenario of a genetic relationship between man and chimpanzees. The old tales

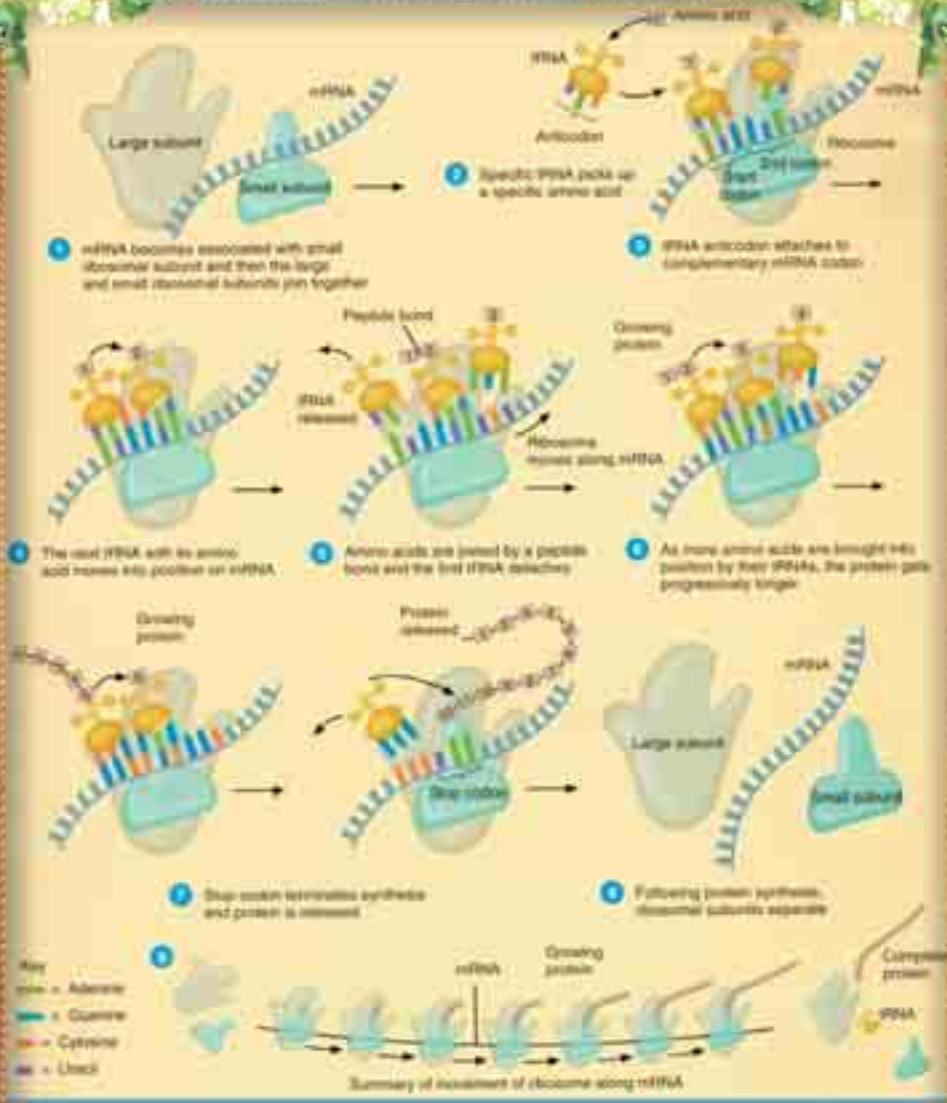

This diagram presents a summary of protein synthesis. All proteins in nature are produced by this complex and specially designed process. No protein comes about by "chance."

of a genetic relationship were trotted out once more, while research, which has revealed that the genetic similarity between the two species has been overstated by up to three times the correct figure, was ignored.

He created all things and He has
knowledge of all things. That is
God, your Lord. There is no deity
but Him, the Creator of everything.

So worship Him. He is
responsible for everything.

(Qur'an, 6: 101-102)

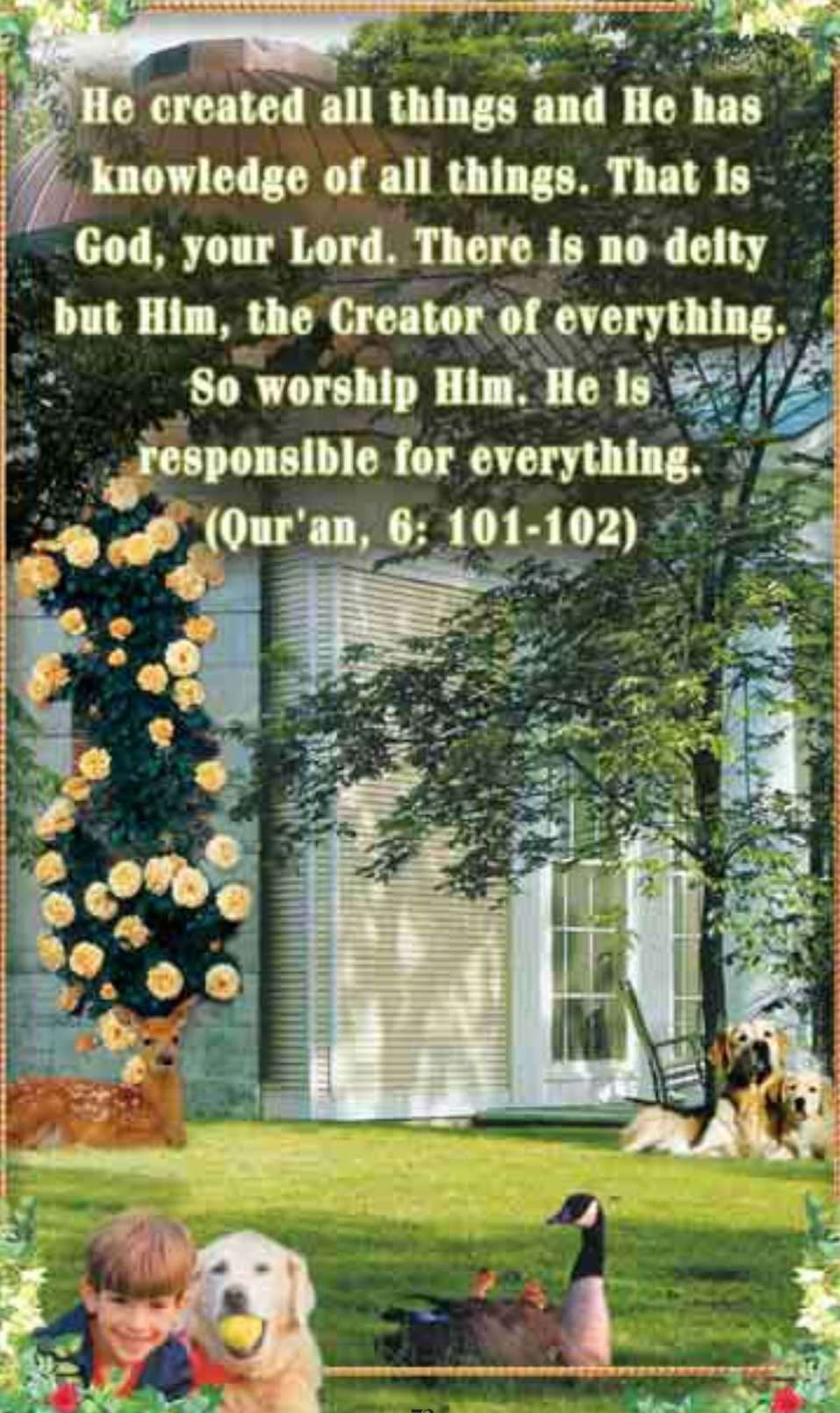

Conclusion: There is no Transformation Between Species

No transformation between species ever happened. Species were created separately, together with their own genetic codes. Those species that have survived to the present day have never undergone any change. The Cambrian Explosion and the structure of DNA are proof of this. The stories about whales and the transition from water to the land supported by National Geographic TV are completely absurd. This channel, which supports nonsense of this kind in the face of modern scientific findings, is behaving in exactly the same way as those who once believed that the Earth was flat. It should give up these superstitions at once.

1. Charles Darwin, *The Origin of Species: A Facsimile of the First Edition*, Harvard University Press, 1964, p. 184
2. Richard Monastersky, "Mysteries of the Orient," *Discover*, April 1993, p. 40.
3. Richard Monastersky, "Mysteries of the Orient," *Discover*, April 1993, p. 40.
4. Phillip E. Johnson, "Darwinism's Rules of Reasoning," *Darwinism: Science or Philosophy* by Buell Hearn, Foundation for Thought and Ethics, 1994, p.12



THE "MITOCHONDRIAL EVE"
DECEPTION ON THE
DISCOVERY CHANNEL

The Discovery Channel recently broadcast a documentary called *The Real Eve*, in which imaginary scenarios were put forward regarding the spread of modern man, who allegedly emerged by means of evolution in Africa, to the rest of the world.

However, scientific discoveries show that the evolution of man is nothing but a fantasy, and that the claims made on The Discovery Channel are unfounded. This article reveals the scientific errors made by the channel.

The program begins with the claim that all human races in existence today are descended from one single woman who lived in Africa some 130,000 years ago, and that this woman was the first representative of *Homo sapiens*, who allegedly emerged through a process of evolution. Since these claims concerning this woman are based on analyses of mitochondrial DNA, this mythical female is known as "mitochondrial Eve."

It is suggested that these human beings, with their large brains, left the continent, maybe to find new resources, and began spreading to the rest of the world some 80,000 years ago. The likely migration routes of one small group of humans, shown wearing primitive clothing, and the incidents that may have taken place during their journey, are depicted. Such issues as climate changes, the relationship between Neanderthals and modern man, and a number of fossil discoveries are also discussed. The Darwinist message is that every person alive today is the product of evolution, and that the traces of this so-called evolution are to be found in our genes.

Yet the genetic facts said to confirm these claims are not actually objective scientific discoveries at all, but rather facts interpreted in the light of evolutionist prejudices. In other words, such interpretations of genes have no realistic basis.

The clearest example of this is the concept of "mitochondrial DNA" (mtDNA), used as the springboard for the evolutionist claims in the program. Mitochondrial DNA analyses always take pride of place in the claims put forward on the program. The alle-

A DEFINITIVE REPLY
TO EVOLUTIONIST
PROPAGANDA

gations that *Homo sapiens* emerged some 130,000 years ago in Africa and that the first Americans came to the continent 20,000 years ago, as well as the speculation regarding the migration routes taken by human beings as they spread out of Africa, are all based on mtDNA.

The fact is, however, that age analyses based on mitochondrial DNA have recently been scientifically disproved!

Until very recently, it was believed that mtDNA was passed on only by the mother, for which reason a woman's mtDNA could be followed down the generations. Evolutionary biologists frequently resorted to mtDNA analyses and used mtDNA to put forward speculation about the origin of life. Yet due to their attachment to evolution as a dogma they interpreted mtDNA in a one-sided manner, and imposed the precondition that the differences between the various examples of mtDNA they examined had to have come about by mutation.

However, a fact that emerged only last year has fundamentally undermined the credibility of these analyses. An article entitled "Mitochondria can be inherited from both parents" in the well-known magazine *New Scientist* described how 90% of the mitochondria in one Danish patient had been passed down from the individual's father. It thus emerged that all the mtDNA research employed to support imaginary evolutionary scenarios was actually meaningless. *New Scientist* confessed this fact in these words:



Paleontological methods based on the fossil record and biological methods based on mtDNA and Y-chromosome analyses yield extremely contradictory results about the dates of the human origins scenario. This is natural, because, neither on the anatomic level, nor on the molecular level, is any organism the "ancestor" of another.

Evolutionary biologists often date the divergence of species by the differences in genetic sequences in mitochondrial DNA. Even if paternal DNA is inherited very rarely, it could invalidate many of their findings.¹

For this reason, the "mitochondrial Eve" thesis put forward on The Discovery Channel has been totally invalidated by the above finding. Evolutionist sources such as The Discovery Channel interpret the genetic differences among the peoples of the world in the light of their own prejudices to reinforce their own theories. That is what invalidates the evolutionist claims based on genetic analyses.

Another research technique pointed to by evolutionists as supporting their "out of Africa" theories is Y-chromosome analysis, based on the study of the Y-chromosome, which can only be passed on by the father. Yet when Y-chromosome and mtDNA analyses are compared, the inconsistency of the evolutionist claims becomes even more obvious. Furthermore, a great many paleontologists fiercely oppose chronologies based on genetic analysis. The paleontological evidence is completely at odds with mtDNA and Y-chromosome analyses.

The researcher Spencer Wells, who studied the differences between the various human races using Y-chromosome analysis, suggests that all human beings are descended from a common ancestor living in Africa some 60,000 years ago. Paleontologists basing their figures on the fossil record claim this happened some 40,000 years earlier. There is obviously an enormous difference between the dates proposed by genetic analysis and the fossil record. Alison Brooks, a paleontologist at George Washington University, says, "The dates don't compare well to the order or the geography of the migration patterns revealed by the fossil record."² The difference between Y-chromosome and mtDNA analyses is even greater. Research based on the latter puts this departure back by 90,000 years, to 150,000 years ago.

It can be seen that evolutionists cannot even agree among themselves about the "out of Africa" theories discussed on The Discovery

**A DEFINITIVE REPLY
TO EVOLUTIONIST
PROPAGANDA**



Evolutionists cannot reach an agreement even on the most basic topics regarding their theory such as when and where the first human beings emerged and how they spread around the world. The "out of Africa" theory (above left) holds that the first human beings emerged in Africa and then emigrated to all around the world. In contrast, some researchers such as Milford Wolpoff maintain that human beings evolved not only in Africa but simultaneously in Africa, Europe, and Asia (below left). These contradictory theories show one thing: that man never underwent an evolutionary process.

Channel. In fact, many evolutionist anthropologists and paleontologists completely oppose the "out of Africa" theory. One group of scientists led by such researchers as Alan Thorne and Milford Wolpoff defend the multi-region theory and put forward discoveries showing that the "mitochondrial Eve" thesis is a work of fantasy. The 68,000-year-old Mungo Man discovered in Australia by Alan Thorne has dealt a serious blow to the "out of Africa" theories, and of course to the "mitochondrial Eve" thesis.³

The reason why there are so many mutually conflicting theses is that the suggested process of evolutionary change is totally imaginary and unreal. Since there was no evolutionary process in the past, everyone comes up with his own individual scenario.

Mutation and the Molecular Clock Deception

The program on The Discovery Channel carries various pieces of speculation about when the first Americans might have reached the continent. This migration was first thought to have taken place 15,000 years ago. The program describes how following mtDNA analyses, the date was put back by another 5,000 years, to 20,000 years ago. One researcher whose views were reported says that a mutational difference had been identified between those people who crossed the Bering Strait to America and those who remained in Asia. He then goes on to comment on the "molecular clock," something that is frequently cited by evolutionist researchers, using the expression "if we assume that a mutation takes place once every 20,000 years ..." Yet this interpretation is nothing but an evolutionist castle in the air, based on no scientific foundation: The concept of the molecular clock used in the identification of genetic mutations is a completely hollow concept, the result of prejudiced views.

It will now be useful to consider this concept, so frequently resorted to in the evolutionists' distortions of the genetic facts, in more depth.

The so-called molecular clock hypothesis assumes that the amino acids in the proteins of living things, or the nucleotides in their genes, change at a particular rate. The claim put forward on The Discovery Channel that human beings undergo a mutation once every 20,000 years is based on that hypothesis. Evolutionists examine the mitochondria of chimpanzees and human beings, who are assumed to have descended from a common ancestor, and identify different nucleotides within the analogous regions of the DNA. Assuming man and chimpanzees to have split apart some 6 million years ago, they divide that 6 million by the number of their different nucleotides, thus coming up with a kind of timetable of imaginary mutations.

Naturally, these claims are based on nothing more than evolutionist prejudice, and have no meaning whatsoever in the face of the

scientific facts. (For further details, see *Darwinism Refuted: How the Theory of Evolution Breaks Down in the Light of Modern* by Harun Yahya, Goodword Books, 2003)

The "winding up" of this molecular clock rests entirely on evolutionist prejudice. In fact, the "clock" in question is not synchronized for that very reason: It was claimed in one article in the well-known journal *Science* that according to one new molecular clock "mitochondrial Eve" must have lived no more than 6,000 years ago.⁴

All this shows that the "mitochondrial Eve" thesis expressed on The Discovery Channel is actually quite meaningless. The essence of the theory is that evolutionists dazzled by the illusion of Darwinism naturally look at genes under the influence of that illusion, and see exactly what they want to see.

The Neanderthal Deception

In that section dealing with the "out of Africa" scenarios, we are told how modern human beings encountered Neanderthals when they reached Europe, and brief information regarding the Neanderthals is supplied. Despite the Neanderthals' being accepted as a human race, Neanderthal Man is still portrayed as a primitive species. The recreations portrayed by The Discovery Channel show Neanderthal Man as a human who screamed instead of using proper speech, a wild thing who howled like a wolf.

The fact is, however, that discoveries regarding Neanderthal anatomy and culture show that there was nothing primitive about Neanderthal Man at all, and prove that they were a human race who lived, thought and spoke, and enjoyed a culture and civilization just like modern man.

The evolutionist distortion in this regard goes back to the 19th century, to the discovery of the first Neanderthal fossil in 1856. The distortions in the skeletal reconstruction made by the French anatomist Marcelline Boule led to Neanderthal Man's being regarded as a brutish ape-man, who walked in a crouch and pos-

essed no culture. In fact, the word "Neanderthal" even entered the English language as a synonym for "crude, ignorant." However, new findings regarding the Neanderthals have shown that this was utterly mistaken, and the idea that they were ape-men has now finally been abandoned.

The Discovery Channel is still serving as a tool for Darwinist propaganda in this area. Its attempt to portray Neanderthal Man as a product of evolution by describing him as "10 times closer to man than the chimpanzee" is a totally meaningless and fictitious comparison.

Conclusion

The "mitochondrial Eve" documentary shown on The Discovery Channel constitutes an enormous deception. The analyses used as evidence have no validity and do nothing more than reflect evolutionist prejudices. The Darwinist propaganda put forward by The Discovery Channel, totally ignoring the scientific facts, has utterly collapsed. Neither *Homo sapiens sapiens* (modern man) nor Neanderthal Man is an evolved species. Both are human, whom God created, with such superior abilities as the power of speech and thought.

1. Danny Penman, NewScientist.com, "Mitochondria can be inherited from both parents," August 23, 2002, <http://www.newscientist.com/news/news.jsp?id=ns99992716>
2. Hillary Mayell, National Geographic News, "Journey Redraws Human's Family Tree" December 13, 2002 http://news.nationalgeographic.com/news/2002/12/1212_021213_journeyofman.html
3. Janine MacDonald, "Mungo Man older than thought," http://cogweb.ucla.edu/EP/Mungo_Man.html
4. Ann Gibbons, "Calibrating the Mitochondrial Clock," *Science*, vol. 279, 2 January, 1998, p. 29.

**THE DINO-BIRD FANTASY ON
THE DISCOVERY CHANNEL**



A documentary about dinosaurs was broadcast on The Discovery Channel in January 2003. Most of the film was devoted to the way dinosaurs lived. Various dinosaur fossils were presented, and speculations advanced regarding their feeding habits and whether they were carnivorous. In the light of major fossil discoveries, particularly on the continents of Asia and America, the program tried to establish the migratory routes that these giant creatures might have followed.

The last 10 minutes of the film consisted of an introduction to the matter of "feathered dinosaurs," so frequently alluded to in evolutionist propaganda. It was maintained that feathers had been found on one fossil, called *Caudipteryx*, and that this fossil represented an intermediate form in the so-called evolution of birds.

The claims made on The Discovery Channel about the fossils are unfounded. The dino-bird theory, based on two fossils, flies in the face of the scientific facts. A wider consideration of the scientific findings that totally undermine the dino-bird theory can be found at our website www.darwinismrefuted.com.

The first of the two fossils given in the film is *Sinosauropteryx*. When this fossil was first found, in 1996, it was claimed that it had structures similar to feathers. However, later detailed analysis in 1997 revealed that these structures had nothing at all to do with feathers. The evolutionists therefore abandoned their claims that the creature had been feathered.

The second species alleged in the documentary to have been feathered is *Caudipteryx*. Evolutionists are unanimous that *Caudipteryx* lacked the power of flight. The creature had short arms and long legs, and possessed an anatomy far better suited to running. The main



Sinosauropteryx

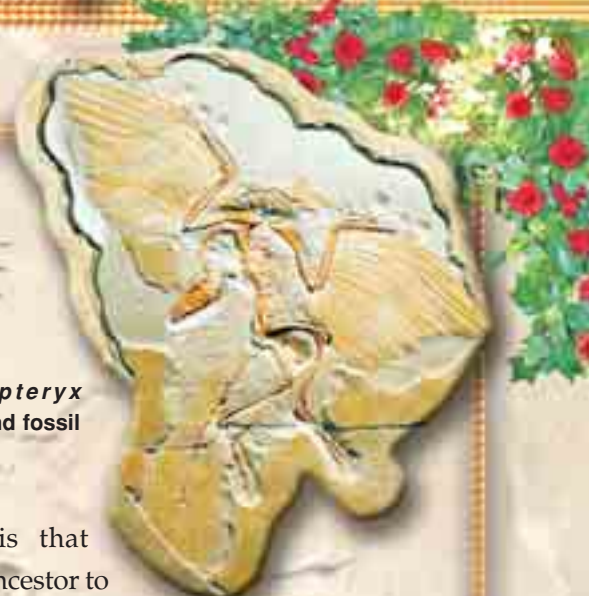

Archaeopteryx drawing and fossil

feature to invalidate the thesis that *Caudipteryx* might have been the ancestor to the birds is its age. *Caudipteryx*, which Phil Currie attempts to portray as a transitional species, is some 120 million years old. *Archaeopteryx*, the oldest known bird, is 30 million years older than that. The 150-million-year old bird *Archaeopteryx* is solid evidence that *Caudipteryx* was not an intermediate species. *Archaeopteryx* lived long before *Caudipteryx* and was able to fly perfectly, just like modern birds.

The dino-bird theory actually constitutes a rather superficial propaganda tool, which is why even some evolutionist scientists reject it. In an article in *New Scientist*, the famous ornithologist Alan Feduccia sets out the anatomical differences between birds and dinosaurs and states that from the paleontological point of view the theory is a disgrace:

Well, I've studied bird skulls for 25 years and I don't see any similarities whatsoever. I just don't see it... The theropod [a bipedal, meat-eating dinosaur] origins of birds, in my opinion, will be the greatest embarrassment of paleontology of the 20th century.¹

Another ornithologist, Larry Martin,



Caudipteryx drawing and fossil

makes this comment in the same article:

To tell you the truth, if I had to support the dinosaur origin of birds with those characters, I'd be embarrassed every time I had to get up and talk about it.²

Birds are the origin of birds. It is out of the question for dinosaurs or any other land animal to have come by the power of flight as a result of gradual mutations. That is because birds' bodies are specially designed to fly. When one examines the bird wing, feather, lung, and other structures, one encounters particular features peculiar to flight that are not found on any land creatures. The most important feature of this design is its irreducible nature. The wing, lung, and feather need to be present in perfect form in order for flight to be possible. One Turkish evolutionist, Engin Konur, says:

The common trait of the eyes and the wings is that they can only function if they are fully developed. In other words, a halfway-developed eye cannot see; a bird with half-formed wings cannot fly. How these organs came into being has remained one of the mysteries of nature that needs to be elucidated.³

Conclusion

In the light of scientific findings, the theory that birds evolved from dinosaurs, as broadcast by The Discovery Channel, is invalid. Evolutionist sources such as The Discovery Channel shut their ears to the scientific facts and continue to portray this piece of fantastic fiction as if it were a scientific theory. We call on The Discovery Channel to abandon this deception, described by the famous ornithologist Larry Martin as "embarrassing," and to look upon birds and dinosaurs as separate species.

1. Pat Shipman, "Birds Do It... Did Dinosaurs?," *New Scientist*, 1 February 1997, p. 28

2. Pat Shipman, "Birds Do It... Did Dinosaurs?," *New Scientist*, 1 February 1997, p. 28

3. Engin Korur, "Secret of Eyes and Wings," *Bilim ve Teknik (Science and Technology)*, October 1984, No. 203, p. 25

The image shows a highly detailed and ornate classical building facade. It features four prominent columns supporting a series of arches. The central archway is the largest and contains a balcony with a decorative railing. Below this, there is another smaller archway. The entire scene is framed by a lush border of red and white flowers with green foliage. The text is centered within the upper part of the facade, overlaid on a dark, decorative band.

**ERRORS CONCERNING HUMAN
INTELLIGENCE FROM THE
DISCOVERY CHANNEL**

The documentary, *Evolution: The Mind's Big Bang*, broadcast on The Discovery Channel, set out a number of Darwinist claims on the subject of human intelligence and culture. Considerable space was devoted to the views of such unrepentant Darwinist scientists as Steven Pinker and Richard Dawkins. This paper examines these Darwinist views and sets out the distortions behind them.

Mankind's Social Identity Did Not Emerge By Means of Evolution

At the beginning of the documentary there is talk of discoveries of ornaments and necklaces going back some 50,000 years. It is then suggested that there was a so-called evolutionary explosion in cultural terms at that time, and various adornments are put forward as evidence of this. These belong to the ancient human race called Cro Magnon. It is stated on The Discovery Channel that these adornments are guessed to have belonged to a pregnant Cro Magnon woman and to have been used to send a message to other people. After explaining that such behavior is an indication of social identity, it is then suggested that these people established social relationships that did not exist in nature.

The claims regarding these ornaments are not consistent, since such adornments are not "indispensable" indications of social identity. The social identity put forward by means of these ornaments could have been expressed by even earlier people in terms of other objects, or even in other ways making not use of objects at all (by gestures, for instance). So, there is no foundation to the idea that one can simply look at an ornament and infer that previously non-existent social identities had been established at the time of that adornment.

Neanderthal Man is a True Human Being

A number of anatomical and cultural features of Neanderthal man are distorted on The Discovery Channel. This distortion can even be seen in the interpretation of the very word Neanderthal. Neanderthal man is spoken of in the documentary as "primitive Stone-Age man." Yet the fact is that Neanderthal means nothing of

WHICH ONE IS THE



1870

Some drawings show Neanderthal man as a family father; others present him as a savage animal or a transitional form between ape and man.

However, in truth, Neanderthals were human beings. Their only difference from modern man is that their skeletons are more robust and their cranial capacity slightly bigger.



1952

the sort. The name of this human race comes from the Neander valley near the German city of Dusseldorf (The first discoveries of this man were made by miners working in a cave in the valley in 1856.)

In the documentary, Neanderthal man is described as having a strong body, with a sloping, narrow forehead, following which there is speculation about his artistic levels. We are told that he left behind him no cave drawings in the habitat he lived in, and it is suggested that he thus left "no clues as to his symbolic life." The pro-

gramme then says that modern man, on the other hand, attaches great importance to art and takes great care over it.

What emerges from this anatomical and artistic comparison of modern and Neanderthal man is not an evolutionary superiority. The fact that Neanderthals had powerful bodies or narrow foreheads is insufficient to demonstrate that they were a primitive species. For instance, we do not conclude that the large inhabitants

REAL NEANDERTHAL?

1909



Although fossil discoveries show that Neanderthals had no "primitive" features as compared to us and were a human race, the evolutionist prejudices regarding them continue unabated. Neanderthal man is still sometimes described as an "ape-man" in some publications. This is an indication of the extent to which Darwinism rests on prejudice and propaganda, not on scientific discoveries.

1962



of Northern Europe are cruder and more primitive than the smaller Chinese or pygmies. That is because bone and skeletal structure is not a criterion for judging behavior and intelligence.

On the other hand, if anatomical features are to be regarded as such criteria, then according to evolutionist logic, Neanderthals must be regarded as more intelligent than modern man, since evolutionists base human intelligence upon brain size. The brain volume of Neanderthal man is some 13% greater than that of his modern counterpart.

The fact that no Neanderthal drawings have come down to the present day is also no indication of primitiveness. There are modern societies which take little interest in art or painting. Looking at their lack of representational art, all one can say about the Neanderthals is that they were "backward in art." Portraying them as a primitive intermediate species solely because they did not make pictures is nothing more than prejudice.



Neanderthal flute

The fact that they did not make pictures is insufficient to show that they had little interest in art. A flute unearthed from a Neanderthal cave in Slovenia demonstrates that these people did have a musical culture. This flute is the oldest known musical instrument. Made from bear bone, it is able to produce notes thanks to four holes specially made in it. There is no doubt that it is only possible to make a flute and produce tunes by means of abstract conception. There is no reason not to assume that these people who interpreted music and produced tunes also entertained themselves by dancing.

Moreover, it has also been demonstrated that the Neanderthals nursed their sick and injured, and buried their dead with flowers. This indicates that they were social beings, possessed of the concepts of love and affection. To maintain that Neanderthals were primitive and on a lower evolutionary level than modern man is nothing than The Discovery Channel's own prejudice.

The Dilemma of Materialism Concealed by Steven Pinker

The Discovery Channel also reported errors regarding the origin of human behavior committed by Steven Pinker, a psychologist

from the Massachusetts Institute of Technology, as though they were true. Pinker makes the following claims:

The actual organization of behavior goes on [at] the level of the individual nerve cells and their connections, and we have a hundred billion nerve cells, probably a hundred trillion connections. It's just mind-boggling to think of all the different ways in which they're arranged in a baby's head. And a lot of our evolution consisted not just in getting more of this stuff, but in wiring it in precise ways to support intelligence.¹

As Pinker makes clear, the human brain is a most complex structure. It is even described as "the most complex thing in the universe" in scientific magazines. Furthermore, the design and processing capacity in the human brain is even used as a model by computer engineers. Dr. Kerry Bernstein, a senior technologist from the well-known company IBM, states in an interview-report called "Brain

**A DEFINITIVE REPLY
TO EVOLUTIONIST
PROPAGANDA**

Teaches Computers a Lesson" published on MSNBC.com, that he holds regular annual conferences attended by neurologists at the IBM headquarters to inform his engineers about the design of the human brain. Bernstein says that the operations of the brain cannot be exactly copied. It operates at roughly 12 kilohertz—the equivalent of 12,000 cycles per second—and burns a fraction of the power computers do, Bernstein says. That makes it exponentially more efficient than the fastest computer, he says. "The reason is be-

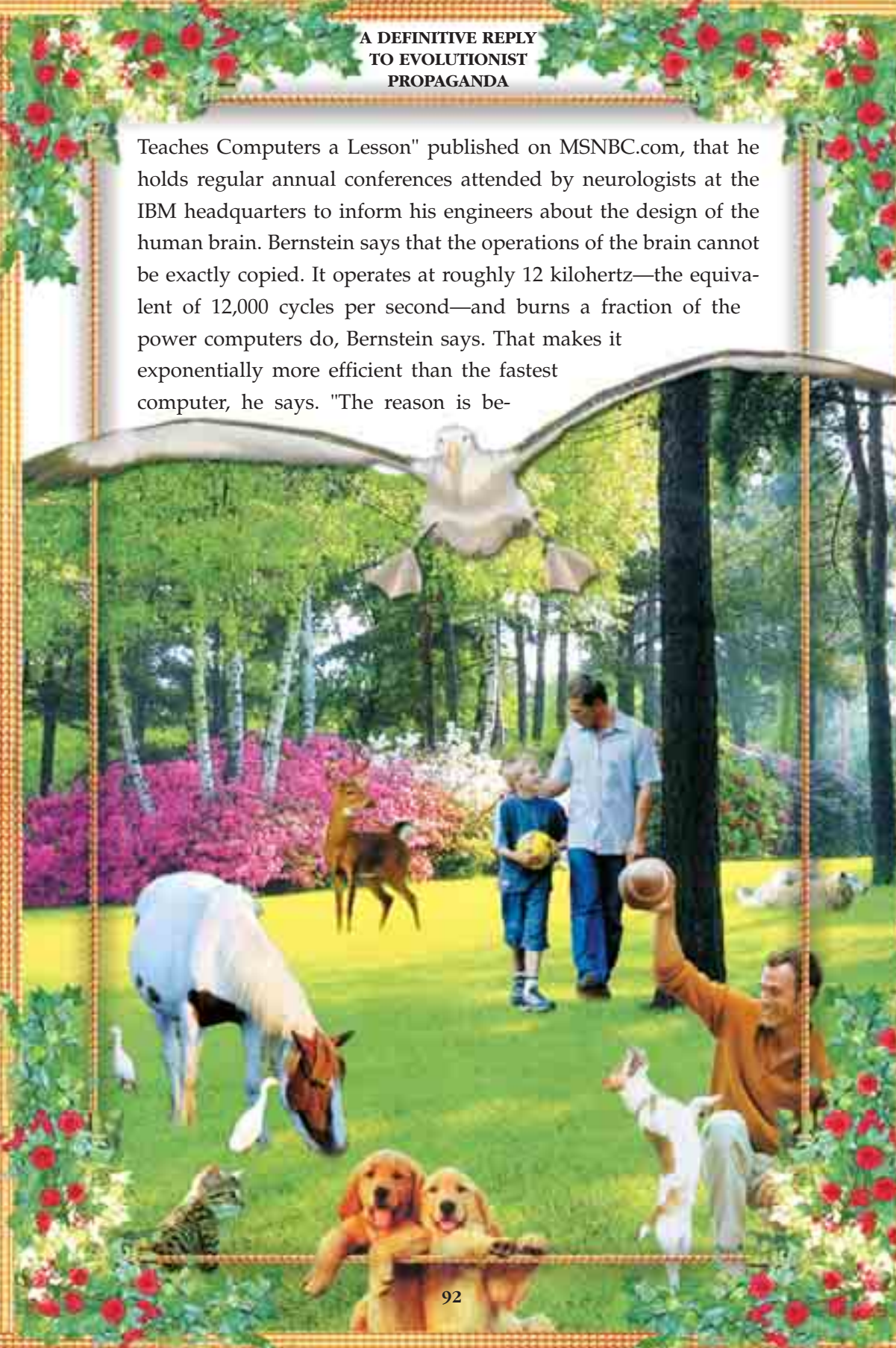

cause of something that we can't do in electronics." Bernstein says. "It's this notion of massive parallelism." Meaning one bit of data can spread to 100,000 other neurons, he said.²

As well as this superior design, the brain also functions most productively. Martin S. Banks, a professor of optometry and psychology at the University of California Berkeley, says, "The brain is efficient in that it doesn't waste energy maintaining information that it will not likely need in real life."³

As we have seen, there is a phenomenal design in the arrangement and functioning of the brain. Pinker and other Darwinists, however, suggest that this order within the brain came about by chance mutations. They claim that atoms bereft of all capacity for thought established the magnificent design in the human brain solely as the result of a long "evolutionary process" based on nothing more than chance. This claim has no scientific foundation and is a violation of reason. Genetic research has shown that there is no question of mutations' adding any information to the genes, and that if they do have any effect, they are always damaging to the organism. Not one artificial mutation carried out in laboratories has ever brought any benefit to a single living thing. Embryos subjected to mutation have been seen to be born dead or crippled. It is clear that mutation could never bring about the "order" within the brain. Such a thing is as impossible as turning an electronic calculator into the most complex computer in the world by smashing it with a hammer.

The claim that behavior is to do with nerve cells and the connections between them is also a dogma. Neuron activity concerning behavior has been detected in the brain, yet no explanation has been offered which might reduce consciousness, the source of all behavior, to the brain.

Behavior consists of the choices of action taken by man to adapt to his environment or to adapt that environment to himself. The possibility of such behavior is dependent upon his having knowledge, in other words consciousness, of his environment. Consciousness, however, is one of the major dilemmas facing mate-

A DEFINITIVE REPLY
TO EVOLUTIONIST
PROPAGANDA

rialism, since it has never proven possible to reduce consciousness to matter: no clues have ever been found as to where consciousness resides in the brain and how it emerges. The question of how consciousness comes about in man, a collection of cells, is still a mystery to materialists. Brain scan studies in the experimental field and theories put forward in the theoretical field have all failed to account for consciousness. Colin McGinn, author of the book *The Problem of Consciousness*, admits this failure in these words:

We have been trying for a long time to solve the mind-body problem. It has stubbornly resisted our best efforts. The mystery per-

Although neuron activity related to behavior has been detected in the brain, no explanation has yet been offered which might reduce consciousness, the source of all behavior, to the brain.

nerve cells

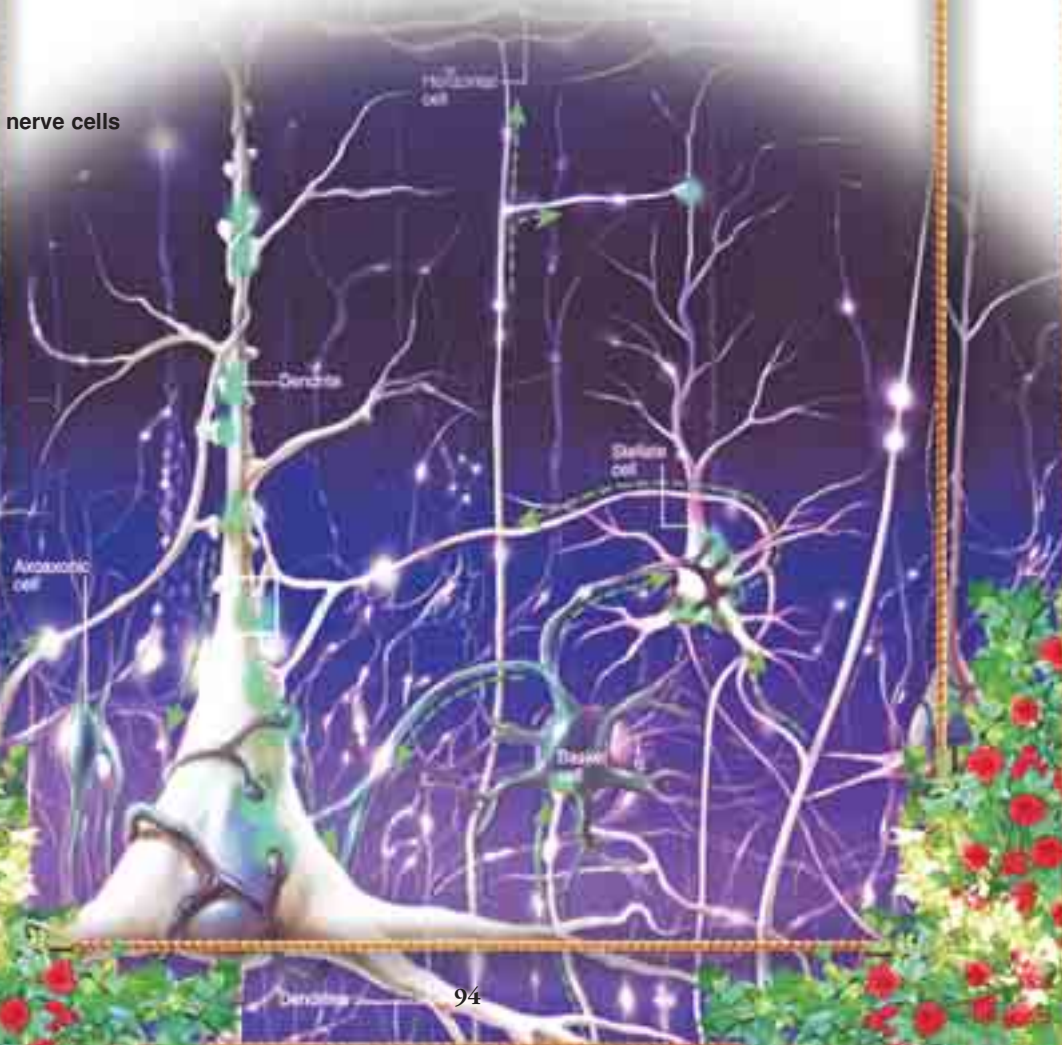

sists. I think the time has come to admit candidly that we cannot solve the mystery.⁴

All this reveals that behavior is not limited to the brain cells. Steven Pinker is actually perfectly well aware of the quandary that consciousness represents for materialism. In basing behavior on the connections between brain cells, he is attempting to cover up this dilemma facing materialism, rather than offering a consistent explanation.

Behavior Aimed at Defending Social Position Is No Proof of Evolution

Taking certain aspects of chimpanzee behavior as a model, The Discovery Channel attempts to establish a relationship between them and man. The documentary explains how when a chimpanzee seeks to influence another chimpanzee whose friendship it hopes to win, it attacks another animal when it begins to annoy the community, thus sending the message that "my friend's enemy is my enemy." However, this example is a comparison based on sheer prejudice; what we have in common with chimpanzees is that we understand the meaning of communications and that this can threaten our social position.

The fact that man and chimpanzees display such common behavior cannot be put forward as proof of any evolutionary relationship between them. Such shows of strength can also be seen among other animals. Elephants, for example, do not allow other elephants to enter regions belonging to their herd. Moreover, the elephant that wins the struggle for leadership of the herd is approved as the new leader by the other members of the community. In other words, just like chimpanzees, many other living things are capable of sending messages to other members of the group in order to defend their own social positions. Yet, the fact that elephants, like man, attach importance to their social position does not of course mean that there is any evolutionary relationship between the two.

**A DEFINITIVE REPLY
TO EVOLUTIONIST
PROPAGANDA**

The Discovery Channel also engages in Darwinist propaganda by suggesting, in the narration accompanying images of a group of chimpanzees, that human beings split away from chimpanzees some 6 million years ago and evolved as a separate primate branch. The truth is, however, that just like other different species in nature, man and chimpanzees are totally different creatures. The claim that they separated from one another 6 million years ago through an evolutionary process has no scientific basis, and is merely a Darwinist assumption. The scientific evidence has revealed that the significance of the fossils put forward as evidence for these scenarios has been distorted. These fossils are not so-called intermediate species, but either the remains of extinct human races or else species of ape. (For the collapse of the scenario of human evolution, see Harun Yahya, *The Evolution Deceit*, Taha Publishers, London, 2003.)

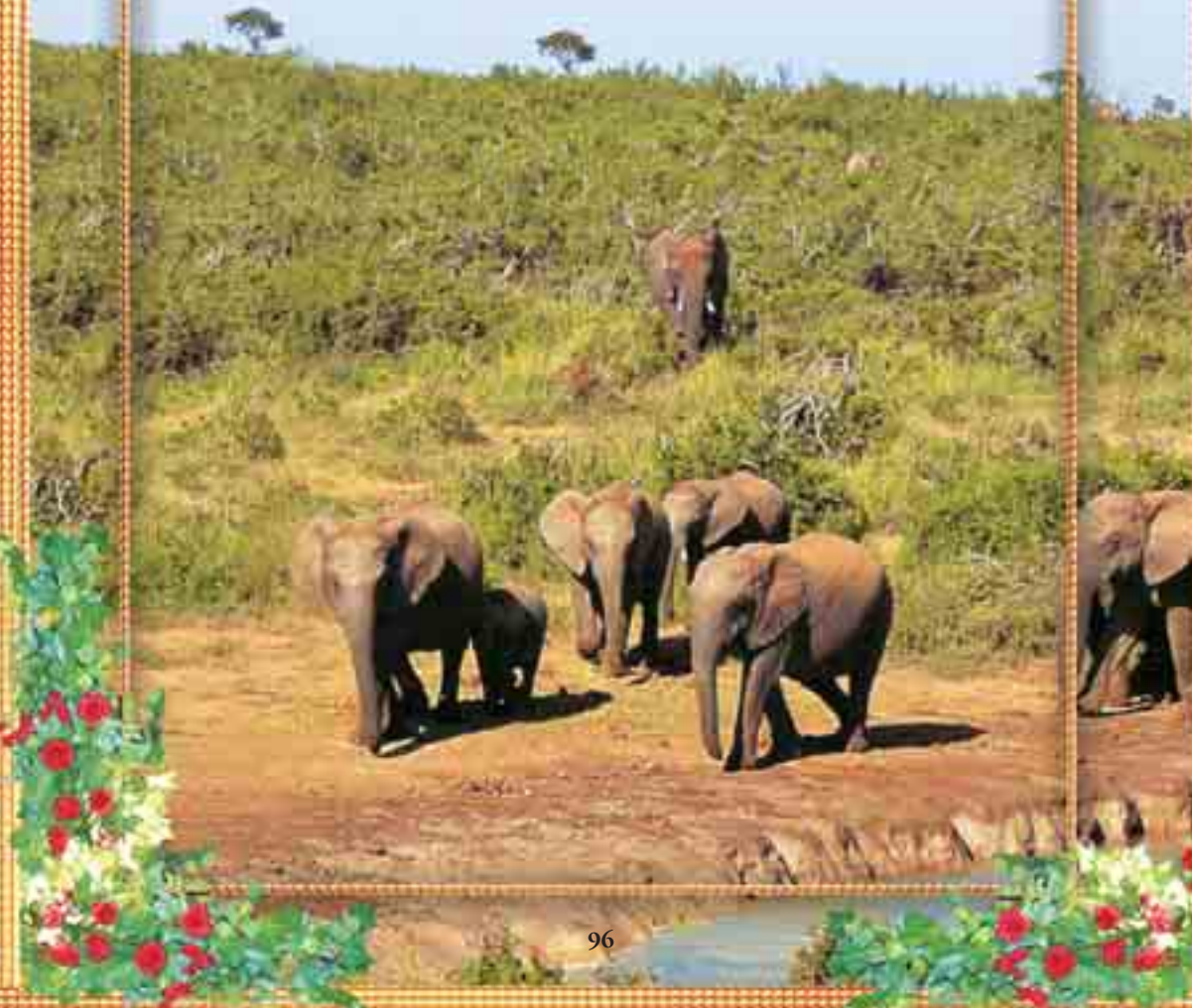

The Discovery Channel's Darwinist Preconceptions About Language

The documentary also contains speculation about the origin of language that are based entirely on fantasy and prejudice. The social benefits conferred on man by language are described as the benefits conferred on individuals in the so-called process of evolution. The claim is then made that the socially most powerful might have been selected during the alleged evolutionary process.

The Discovery Channel is unable to offer any scientific proof for this claim, and deals with it in a fairy-tale manner. It takes man's ability to speak, and artificially pastes it onto natural selection, the classical idea at the heart of the theory of evolution. Needless to say, one-sidedly portraying a series of imaginary claims lacking in any scientific foundation as though they were scientific fact is not a scientific approach.



A DEFINITIVE REPLY
TO EVOLUTIONIST
PROPAGANDA

Language, which allows man to think and establish communication with others in a most perfect manner, is a miraculous ability unique to man. All human beings possess language-learning ability from the moment of their birth. A baby anywhere in the world can learn any language spoken anywhere in the world.

Structurally, language rests on complex grammatical and syntactical rules. An utterance consisting of two or three words might appear to be something really rather simple. However, in order for a person to produce it, a great many very complicated processes must be carried out within a very short space of time. Abstract concepts regarding the issue in question are brought to mind, appropriate words are chosen, and then the words are arranged in the right order. All of this must happen for the original thought to be communicated to someone else.

Frank Guenther of Boston University says, "Speech is easily the most complicated motor act humans carry out."⁵ Guenther states that during speech the brain controls more than 100 muscles in the face, throat, chest, and abdomen, and emphasizes that all of this happens spontaneously without our needing to think about it. Guenther describes how a five-syllable word, including eleven discrete phonemes, takes most people less than a second to say. Furthermore, we do not have to worry about which muscles to tighten or loosen as we speak. Speech is literally a miracle.

Seeking to offer a Darwinist explanation of the origin of language, The Discovery Channel also deals with gossip in terms of natural selection. After stating that gossip comprises two-thirds of human conversation, the channel says that gossip is actually capital, and that the first person to learn how to do it acquired information that could be negotiated with others, for which reason gossip is an evolutionary benefit.

This claim about gossip is actually nothing more than fantasy, of course. Moreover, it is not even consistent, because gossip is not capital. If it were, then those who gossip most would today be the most respected individuals in society.

God brought you out of your mothers' wombs knowing nothing at all, and gave you hearing, sight and hearts so that perhaps you would show thanks.

(Qur'an, 16: 78)



Richard Dawkins' Distortions

The Discovery Channel also devotes space to the claims of Richard Dawkins, an unrepentant Darwinist, atheist, and Oxford University zoologist. Dawkins considers all forms of cultural behavior (ideas, gestures, etc.) under the heading of "meme." Dawkins describes memes as ideas passed on by one human being imitating another, and suggests that in the same way that the genes copy DNA and pass it on from person to person, the memes that constitute the mind and shape behavior are similarly copied and handed on from one person to another. The idea is that, just as the so-called competition between genes shaped biological evolution, so too the competition between memes shaped the brain and culture. Dawkins later suggests that memes—i.e., mimicry or assimilation—are the propulsive force behind human evolution.

The ideas Dawkins describes with the concept of memes can of course change and develop. For instance, ideas can be discussed and other ideas added as a result. Cultural progress can thus take place. In addition to this, human behavior and the behavior of other human beings may be imitated. There is nothing wrong with Dawkins' account up to this point. The error lies in suggesting that this is evidence for so-called human evolution. Mimicry is concerned with abstract thought. Man is the only being possessed of reason and capable of transmitting, copying, and developing ideas. No relationship based on mimicry can possibly be established between man—who creates works of art, develops scientific theories, and designs and debates political regimes—and animals, bereft of all capacity for abstract thought. Instead of considering and defining a property that is unique to man, Dawkins should first of all explain how abstract thought might have emerged during the so-called transition from animal to man. What evolutionists are unable to explain is this: How is it that an animal that is unable to think or

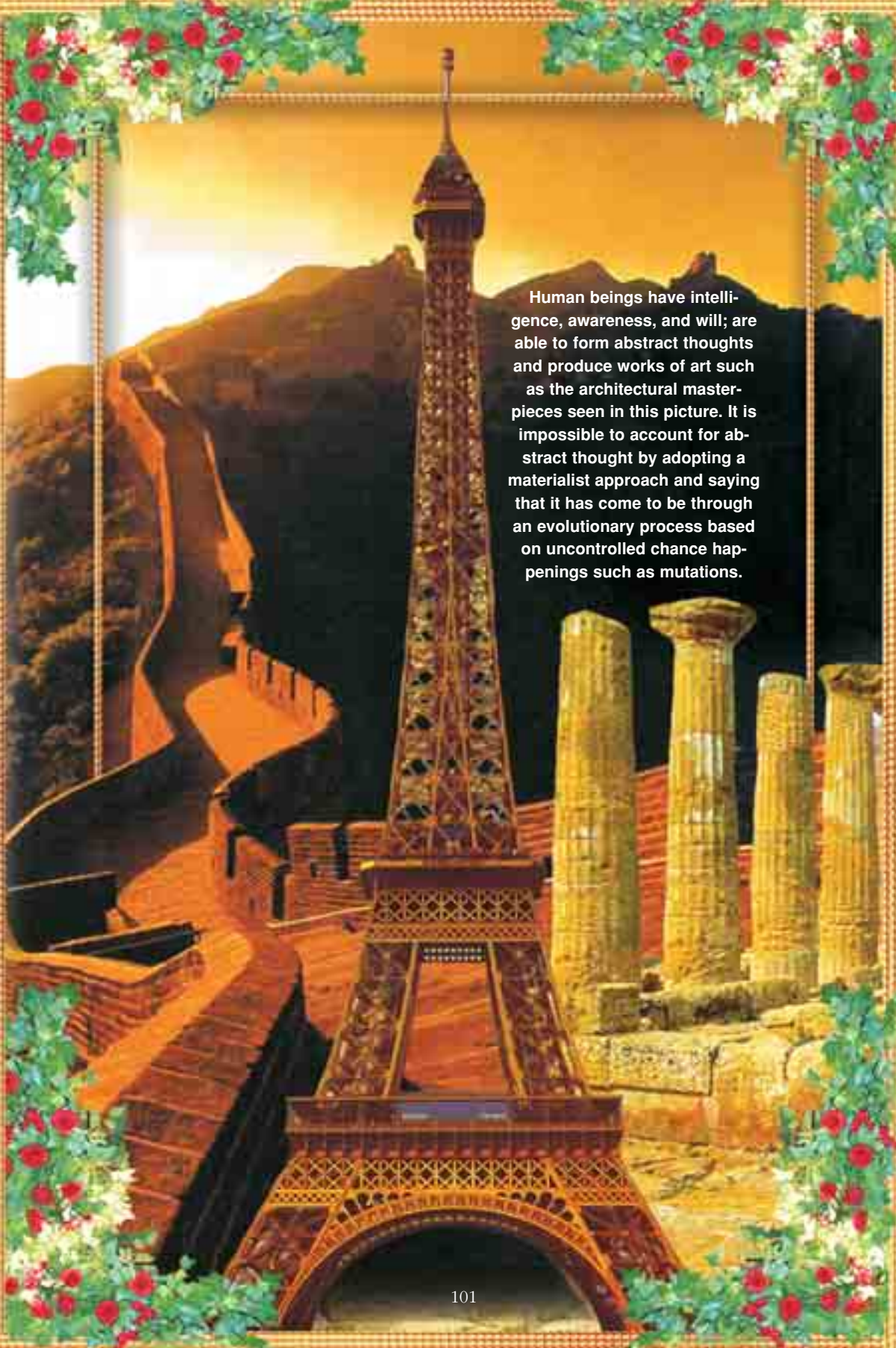

Human beings have intelligence, awareness, and will; are able to form abstract thoughts and produce works of art such as the architectural masterpieces seen in this picture. It is impossible to account for abstract thought by adopting a materialist approach and saying that it has come to be through an evolutionary process based on uncontrolled chance happenings such as mutations.

**A DEFINITIVE REPLY
TO EVOLUTIONIST
PROPAGANDA**

speaking and unable to establish detailed connections between itself and its surroundings, could possibly turn into a human being able to speak and think and possessed of reason and high intelligence? By what evolutionary mechanism could this mental gulf have been bridged?

Naturally, neither Dawkins nor other evolutionists have a consistent reply to these questions. That is because it is impossible to account for abstract thought by adopting a materialist approach, as Colin McGinn has admitted.

Dawkins has no evidence at all of how so-called evolution might have bridged this gulf, and his claim is a totally imaginary one.

"If cultural heritage replicates itself, like DNA molecules, then a new theory of Darwinism might emerge."

No further comment is made after The Discovery Channel puts this suggestion forward. Yet, an explanation of what a cultural accumulation is and how human culture might emerge from the replication of such an accumulation needs to be made. For that reason, these superficial statements have no meaning at all on the scientific level.

Finally, the claim that there is competition between genes and that this competition shaped biological evolution is invalidated by the effect of chance mutation. Like all evolutionists, Dawkins has adopted the dogmatic idea that the vast amount of information concealed in DNA emerged by chance. Genetic research has demonstrated that it is impossible for chance mutations to add information to species' DNA and thus turn them into other species. You can read about the scientific evidence for how mutations—the genetic stronghold of evolution—actually put the theory into a quandary in www.darwinismrefuted.com based on the works of Harun Yahya.

Conclusion: The Origin of Human Reason is Creation, not an Evolutionary Big Bang

Human beings are very superior to other living things. The civilization established by man reveals an extraordinary accumulation of knowledge. Philosophy, medicine, universities, science, technology, politics, art ... the origin of all of these stems from consciousness. Consciousness, language, and speech are concepts that cannot be explained in terms of materialism. Man has no physical or psychological relationship to chimpanzees. It is not possible to talk of the mind's big bang through evolution, which is itself unable to account for reason in the first place. The great error of Darwinism is clear. Mutations which came about by chance cannot have caused a "big bang" in human brain and led to "the world's most complex" design, the human mind.

The truth, which evolutionists refuse to accept, is evident: it is impossible to account for human reason and consciousness in terms of materialism. The atoms in the brain cannot feel, know, or speak. There is no doubt that the source of the human brain is not atoms, but the inspiration of our Lord.

1- Steven Pinker, *Evolution of the Mind*, WGBH Educational Foundation
http://www.pbs.org/wgbh/evolution/library/07/2/text_pop/1_072_03.html

2- Rutland Herald, "IBM engineer looks to brain for new technology," April 12, 2003, <http://rutlandherald.nybor.com/Archive/Articles/Article/49517>

3- "Brain's method of merging input depends on which senses supply it" http://www.eurekalert.org/pub_releases/2002-11/uop-bmo111902.php

4- Colin McGinn, "Can We Solve the Mind-Body Problem?" *Mind*, 98 (1989), p. 349

5- "Repeat After Me," *Discover*, November 2002



**THE DISCOVERY CHANNEL'S
SPIDER DILEMMA**

The Discovery Channel recently broadcast a documentary called *Discovery Journal: The Spider*. The documentary gives examples of the hunting techniques employed by various species of spider and stresses what a superior substance spider thread is.

It describes how spider thread is much stronger than steel, and mentions the technological and industrial fields in which this material could be used once it has been artificially replicated. The channel produced a most entertaining programme with its close-ups of spiders and their webs. Yet, when it came to the origin of spiders, The Discovery Channel made a comment that at once cast a shadow over its scientific credentials, saying, "It is by no means easy to imitate this material, which is the product of 380 million years of evolution."

The evidence put forward on the channel for this claim consisted solely of statements by a scientist who discovered 380-million-year-old fossilized spinneret (the organ at the rear of the spider from which it produces its thread). This scientist claimed that he had found the distant ancestors of spiders, and said that when he dissolved 380-million-year-old rocks and examined them under the microscope he had identified the spinneret inside them. Yet, there was absolutely no proof that these spinnerets belonged to "spiders' distant ancestors," and not a real spider. The spinnerets display absolutely no intermediate form characteristics, and no difference has been found between them and those of modern spiders.

The Discovery Channel's portrayal of this fossil as spiders' distant ancestor is nothing more than a deception. That is because the scientific

Spider fossil in amber



A DEFINITIVE REPLY
TO EVOLUTIONIST
PROPAGANDA



world has known for some 20 years that there is no difference between 380-million-year-old spiders and present-day ones. At its annual conference in 1983, the American Association for the Advancement of Science put forward important fossil discoveries regarding these creatures. The interesting thing about these 380-million-year-old fossils of spiders, ticks, and centipedes is that they are no different from their modern counterparts. One of the scientists who examined the fossils remarked that "they looked like they might have died yesterday."¹ It is stated on the Australian Museum website that 380-million-year-old examples of the spider *Attercopus fimbriungus* possessed silk-producing organs even then.² These fossils reflect the origin of spiders in the most realistic manner and invalidate The Discovery Channel's claims: Spiders emerged not by evolution, but suddenly and perfectly formed, and have undergone no change in the millions of years that have followed.

On the other hand, it also shows that the evolutionist interpretations of spider silk and the complex features of their webs are utterly forced. For instance, spider thread is so light that one kilogram of it could stretch around the earth three times. Despite being so light, spider thread is five times stronger than steel of the same weight. Thanks to its elasticity, it can stretch up to four times its own length. All of this is made possible by the special structure and arrangement of the atoms which make up spider thread. Moreover, although spider silk is solid in web form, it is a liquid in the spider's body. As soon it makes contact with the air, it solidifies as the result of a rapid reaction. Yet, spider thread, which is "the envy of chemists and materials scientists everywhere," as one American newspaper put it, can also revert to its original form.³ By eating its own web, the spider can turn it back into liquid form for re-use later.

Alongside this web-production, web-weaving is also a complex behavior. Although the spider's brain is no larger than a grain of salt, an architectural plan can be seen in the web it spins. The spider drops its thread down from where it sits and waits for the wind to carry it somewhere it can stick to. It then sticks the other end of the

thread to another suitable point. After having drawn a few diagonal struts in this way, it starts to fill in the gaps between them with circular links. Anything coming into contact with the web is swiftly immobilised. Yet, the spider itself is unaffected by the adhesive nature of its web.

In other words, for the spider to have come about by evolution, both the web with its exceedingly complex biochemical structure, and the complex behavior allowing the spider to make use of the web, would have to have come about by means of chance mutations. It is clear that this is impossible. Moreover, there is absolutely no experimental, observational, or fossil evidence to support this evolutionist claim.

On the contrary, the evidence deals a mortal blow to evolution: the fact that 380-million-year-old spider fossils are no different from modern spiders, and the complex structure of the web, pose insuperable difficulties for evolutionists. Given these difficulties, The Discovery Channel declines to touch on the subject of how an organ that produces a substance with such superior properties, which scientists are trying to imitate, could have evolved by chance mutations. It therefore resorts to familiar old stories. The channel starts off with the shape of the nest, which spiders erected between plants on the ground and which contained a downward-pointing funnel: "These nests in the shape of funnels turned into a silken layer as the spiders climbed up on the trees. The gradually developing layer turned sideways, took shape and the circular web formed."

The Discovery Channel may imagine that with this story it has overcome the problem of the origin of spiders. If so, it is mistaken, because the web it places at the beginning of its story must have been made of spider thread with a flawless structure. Since it offers no proof that webs close to the ground are ancient in evolutionary terms, whereas those high up are more recent, it places spider webs in an imaginary chronological framework.

Conclusion

The Discovery Channel's ideas regarding the origin of spiders are nothing more than an expression of its terrible quandary on the subject. The true origin of the spider and its web, which place the channel in such difficulties, is creation. It is God, the Lord of the Worlds, the Lord of Infinite Knowledge and Might, Who creates the spider and its web-producing system, and Who inspires it to spin its webs. No matter how hard they may try, evolutionists can no longer conceal this evident truth.

1. *San Diego Union*, New York Times Press Service, 29 May 1983; W. A. Shear, *Science*, vol. 224, 1984, p. 494
2. Australian Museum Online, 2002
<http://www.amonline.net.au/spiders/diversity/what/origins.htm>
3. Stephen Reucroft and John Swain, "Spider silk mystery solved," *Boston Globe*, 10/22/2002

**EVOLUTIONIST PROPAGANDA
ON THE HISTORY CHANNEL**



Towards the end of January, The History Channel television company embarked on evolutionist propaganda consisting of four programs. Interestingly enough, this propaganda was not limited to The History Channel, since other channels such as National Geographic and The Discovery Channel stepped up their own evolutionist propaganda at exactly that same time.

Behind these broadcasts, initiated from three different directions, lie developments that have recently taken place in the scientific world and which prove the invalidity of the theory of evolution. These pro-evolution channels intend their propaganda campaign to cover up the damage these discoveries have done to the theory.

The series which The History Channel has begun to broadcast comes under the title *Ape Man*. However, since The History Channel first broadcast these programs there have been new developments that have further undermined the scenario of human evolution. The History Channel has deliberately ignored these developments and has not hesitated to broadcast the old stories that are no longer of any value at all in the face of new findings. We present below the developments in question for The History Channel's attention and call on it not to broadcast material that flies in the face of the scientific facts for the sake of Darwinist propaganda.

The Collapse of the Human Evolution Scenario; April 2002- January 2003

Fossils from Georgia Deal a Mortal Blow to the Human Evolution Scenario

July 4 – Skull fossils unearthed during an archaeological excavation in Dmanisi in the Republic of Georgia in 1999 caused a widespread reaction in the scientific world. The age and features of these fossilized bones were of a kind to challenge the evolutionist

chronologies. Based on these fossils, a number of eminent paleontologists stressed the invalidity of certain classical evolutionary scenarios at the Seckenberg Conference in Germany.¹ The latest skull fossils found at Dmanisi deepen still further the damage done to evolutionary scenarios by the first discoveries. The fossils caused great excitement in the media, and were reported by MSNBC under the headline "Fossil Discovery Upsets Theory on Human Origins."² Paleontologists seeking the imaginary "missing link" were no longer able to defend their old claims in the face of the picture now emerging with the increasing number of fossils that failed to fit in with the evolutionist chronology. No concrete proof to show that there had been evolution from ape to man had been found anywhere in the fossil record.

The Fossil That Made Them Confess:

Sahelanthropus tchadensis

July 7 – The fairy story of evolution that has been recounted for the last 150 years was dealt another blow by a fossil skull found in Chad and named as *Sahelanthropus*. Daniel Lieberman, an anthropologist from Harvard University, described the seven-million-year-old fossil as the discovery of the century and said, "This [discovery] will have the impact of a small nuclear bomb."³ The fossil definitively overturned the evolutionist myth of a gradation beginning with apes and ending in modern man. It was understood that the idea of the "ape-man" acquiring a gradually more modern appearance, as maintained in newspapers and magazines, was untrue. Moreover, it was also realized that the so-called missing link (between man and ape), widely used as a propaganda tool and which evolutionists claimed would inevitably be discovered one day, was actually missing because it did not exist. The paleontologist Henry Gee, the editor of the famous journal *Nature* which announced the fossil discovery to the world, described it as "the most important discovery in the search for human origins in living memory" and wrote the following in an article in the *Guardian* newspaper:

Whatever the outcome, the skull shows, once and for all, that the old idea of a "missing link" is bunk... It should now be quite plain that the very idea of the missing link, always shaky, is now completely untenable.⁴

Forced Speculation in Time Magazine

August 27 – Detailed analyses by Joseph Mastropaolo, a world-famous scientist and member of the American Physiological Society, invalidated *Time's* evolutionist propaganda. *Time* magazine had announced to the world that the fossils of the species *Ardipithecus ramidus kadabba* discovered by the University of California at Berkeley anthropologist Yohannes Haile-Selassie in Ethiopia represented the "missing link." In its cover story dated July 23, 2001, and entitled "Meet your newfound ancestor, a chimplike forest creature," *Time* discussed the fossil in question in terms of a bipedal evolutionary ancestor. Evolutionists who studied the fossil had claimed the creature was 5.5-5.8 million years old and capable of bipedal

On the cover of *Time* magazine's July, 23, 2001, issue was a painting of an ape-man called *Ardipithecus ramidus kadabba*. The painting was based on some fragmentary bones recently found in Ethiopia. *Time* assured its readers that the creature walked upright, giving as evidence for this nothing but a single toe bone which was actually found some sixteen kilometers (ten miles) from the other bones. However, *Time's* claim that this creature was a human ancestor was discredited by later studies on the toe bone.



walking. However, the bone they based all these claims on was just a single toe. Some 95% of the skeleton was missing, yet evolutionists still made the totally unrealistic claim that this toe supposedly showed that this creature was capable of walking on two legs, which showed in turn that man and apes evolved from a common ancestor. The evolutionist magazine *Time* felt no need to question whether its claims rested on any scientific foundation, and portrayed to the world these evolutionary tales, embellished with pictures of ape-men, as scientific fact.

Mastropaolo, regarded as one of the most respected authorities in the world of paleontology, wanted to be sure of the facts by examining the toe himself. He compared the *Kaddaba* toe bone to those of man, chimpanzees, and baboons. Comparing the anatomic criteria from a mathematical perspective, Mastropaolo arrived at very different results. The toe did not resemble those of chimpanzees or baboons at all. The resemblance between it and the human toe was also insufficient.

Mastropaolo's findings were unveiled at the San Diego Conference held by the American Physiological Society on August 27, 2002. It was made clear in the concluding part of the paper that the idea of an evolutionary ancestor walking upright was a work of pure imagination:

Accordingly, the objective ancestry analyses for fossil bones assert that the conclusions of Haile-Selassie and Robinson were farfetched speculations.⁵

"Chimps on Two Legs Run Through Darwin's Theory"

September 13 – The report of a discovery in the well-known Scottish newspaper, *The Scotsman*, tore down another of the classical myths of evolution. We have all seen the ape-man diagrams in evolutionist newspapers and magazines, which begin with an ape



A news report in the Scottish newspaper *The Scotsman* revealed that scientists studying chimpanzees in Uganda have discovered groups of chimpanzees walking around on two legs. This discovery destroyed the false evolutionist claims holding that man evolved from quadrupedal apes and that an evolutionary progression took place from primitive to more developed species.

walking on four legs and then take on increasingly human characteristics, finally arriving at modern man. According to the theory this progression is based on, human beings evolved from so-called apes that walked on four legs. However, one group of chimpanzees discovered by Liverpool University anthropologist Dr. Robin Crompton belied that tale. The researcher encountered chimpanzees in Uganda's Bwindi jungle area that were able to walk on two legs. The Scotsman covered the story under the headline "Chimps On Two Legs Run Through Darwin's Theory." Dr. Crompton commented, "This is contrary to the accepted idea that we evolved from chimpanzees which were knuckle-walking – or walking around on all fours."⁶

The Genetic Difference Between Man and Chimpanzee Trebled

September 23 – There was one story that evolutionists created with false information and one-sided interpretations that was used to make the headlines for decades: The idea that man and chim-

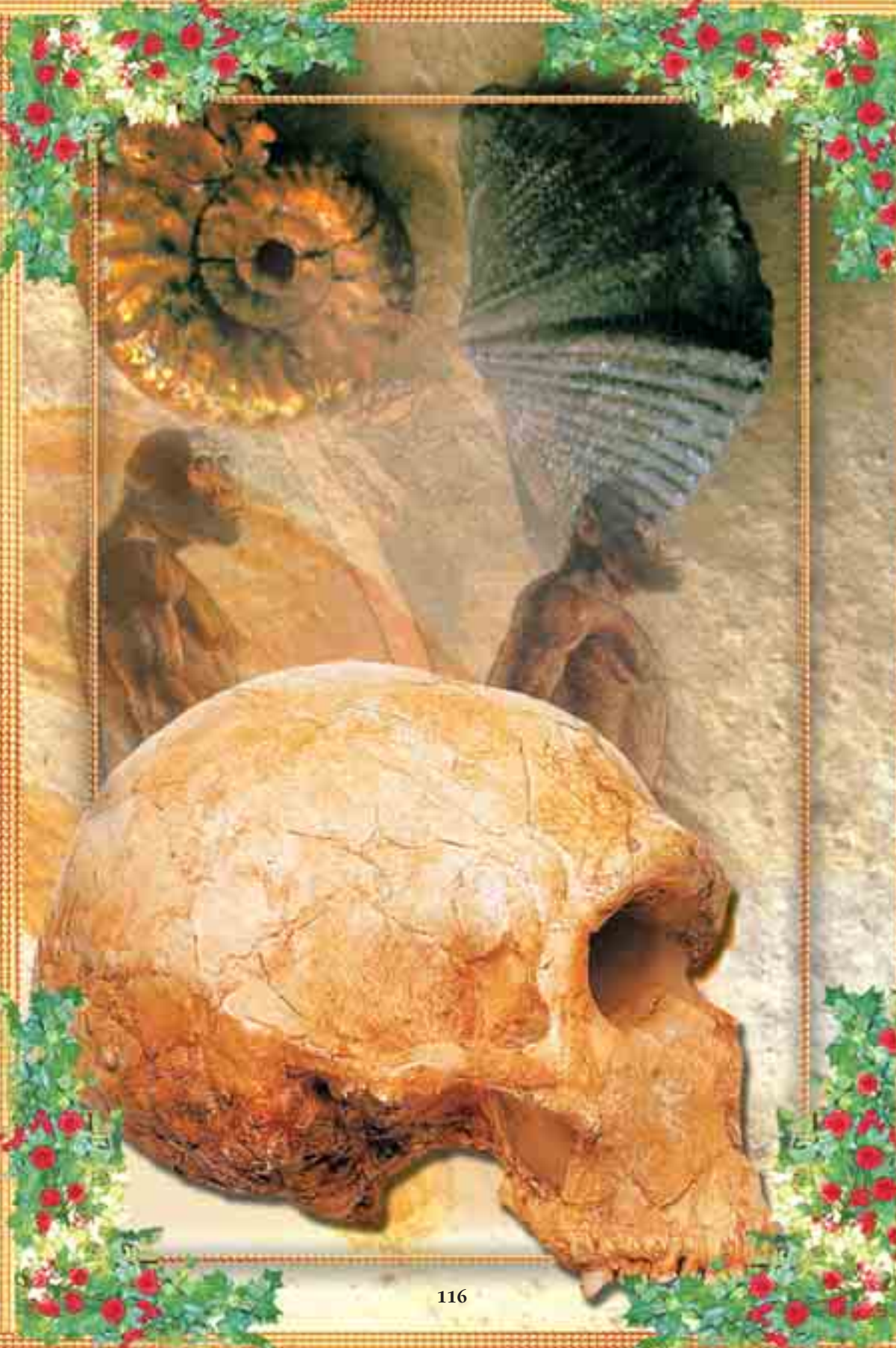

panzees were related, based on genetic analyses. One piece of research revealed that the genetic difference between man and chimpanzees was three times greater than had been believed.⁷ The way this piece of research widened that difference showed the invalidity of the evolutionists' claims about genetic relationships.

Conclusion

As we have seen, there have been a large number of scientific developments in a period of just six months that have clearly demonstrated the invalidity of the theory of evolution with regard to the origin of man. The History Channel must no longer hesitate to confront the scientific facts it has sought to conceal. Instead of blindly engaging in Darwinist propaganda, it must explain, clearly and in full as a history channel, how the scientific discoveries of the last 150 years have actually demolished Darwinism.

1. Pat Shipman, "Doubting Dmanisi," *The American Scientist*, November-December 2000, p.491
2. MSNBC.com: "Fossil Discovery Upsets Theories on Human Origins," 4 July 2002
3. D. L. Parsell, "Skull Fossil From Chad Forces Rethinking of Human Origins," *National Geographic News*, July 10, 2002
4. Henry Gee, "Face of Yesterday," *The Guardian*, 11 July 2002
5. Eurekalert.com: "Oldest Human Ancestor is (Again) Called into Question," August 27, 2002
6. Richard Sadler, "Chimps on Two Legs Run Through Darwin's Theory," *The Scotsman*, September 13, 2002
7. Newscientist.com: "Human-chimp DNA difference trebled," September 23, 2002, <http://www.newscientist.com/news/news.jsp?id=ns99992833>



**THE HISTORY CHANNEL'S
DARWINIST AND ATHEIST
PROPAGANDA**

The History Channel is broadcasting a film in its *Biography* series, which deals with the life and views of Charles Darwin. In this film, Charles Darwin's unscientific views are defended on the basis of no evidence at all, as if they were proven fact, and there is at the same time open atheistic propaganda. The fact that a channel such as The History Channel, which claims to give viewers the historical and scientific truth, should devote space to Darwinist views, which are in no way compatible with the scientific facts, casts a shadow over its credibility.

Why are They Trying to Keep the Theory of Evolution Alive with Propaganda?

In recent weeks, a number of channels such as The History Channel, The National Geographic Channel, and The Discovery Channel have initiated an intense campaign of evolutionary propaganda. Documentaries that discuss the theory of evolution and praise Charles Darwin have been dusted off the shelves and screened, as if a common decision to that end had been taken. What is the reason for this? In our view, there is an attempt to repair the damage that scientific discoveries have done to the theory of evolution in recent years, and especially in recent months. As followers of the www.darwinism-watch.com website will know, discoveries in the fields of paleontology, molecular biology, and genetics have revealed a grave contradiction with the claims of the theory of evolution. Even evolutionists accept this. (You can find many instances of this in the archives of www.darwinism-watch.com.)

It is actually quite natural that the theory of evolution should have come to such an end. The real architect of the theory, Charles Darwin, lived in the 19th century and was unaware of most of the fields of science that exist in our time. For instance, since he was unaware of genetics, he believed that living species could be im-

**A DEFINITIVE REPLY
TO EVOLUTIONIST
PROPAGANDA**

proved, in the way that stockbreeders do, and new species could be obtained. Thanks to the science of genetics, however, it emerged that stock improvement could not lead to the appearance of new species. He was similarly unaware of cell biology, and since he worked with the crude microscopes of his own time he assumed that the cell was a very simple structure, for which reason it might have emerged by chance. In our day, however, microbiologists regard the cell as a structure of incredibly flawless organization and complexity, on the order of the city of New York or a space ship, and consider it as totally impossible for the cell to have come about by chance. It was natural that Darwin, ignorant of all these branches of science and lacking technological facilities, should be influenced by certain similarities he observed between living things to form a theory, and for that theory later to collapse under the weight of scientific findings. The history of science is full of similar examples.

However, there is another point here, one which is by no means normal and for which there is no parallel in history: Despite the fact that Darwin's theory has been belied by scientific discoveries, it has not been annulled like so many other theories. Rather, some scientists have tried and are still trying to defend the theory. That is the point which needs to be concentrated on. Even though science has clearly rejected the claim that living things evolved by chance, why is the theory of evolution still receiving such support?

It is no secret that the theory of evolution denies the fact that living things were created according to intelligent design as it seeks to find a so-called account for the origin of life. For that reason, the theory acts as the defender of atheism in the scientific arena. That is why those who deny intelligent creation and the existence of a Creator possessed of superior power are so fiercely devoted to the theory of evolution. Since the collapse of the theory of evolution means the collapse of their own atheist and materialist beliefs, they engage in evolutionist propaganda with all their might. Some of the major and indispensable elements of this propaganda are organizations like The History Channel, The National Geographic Channel,

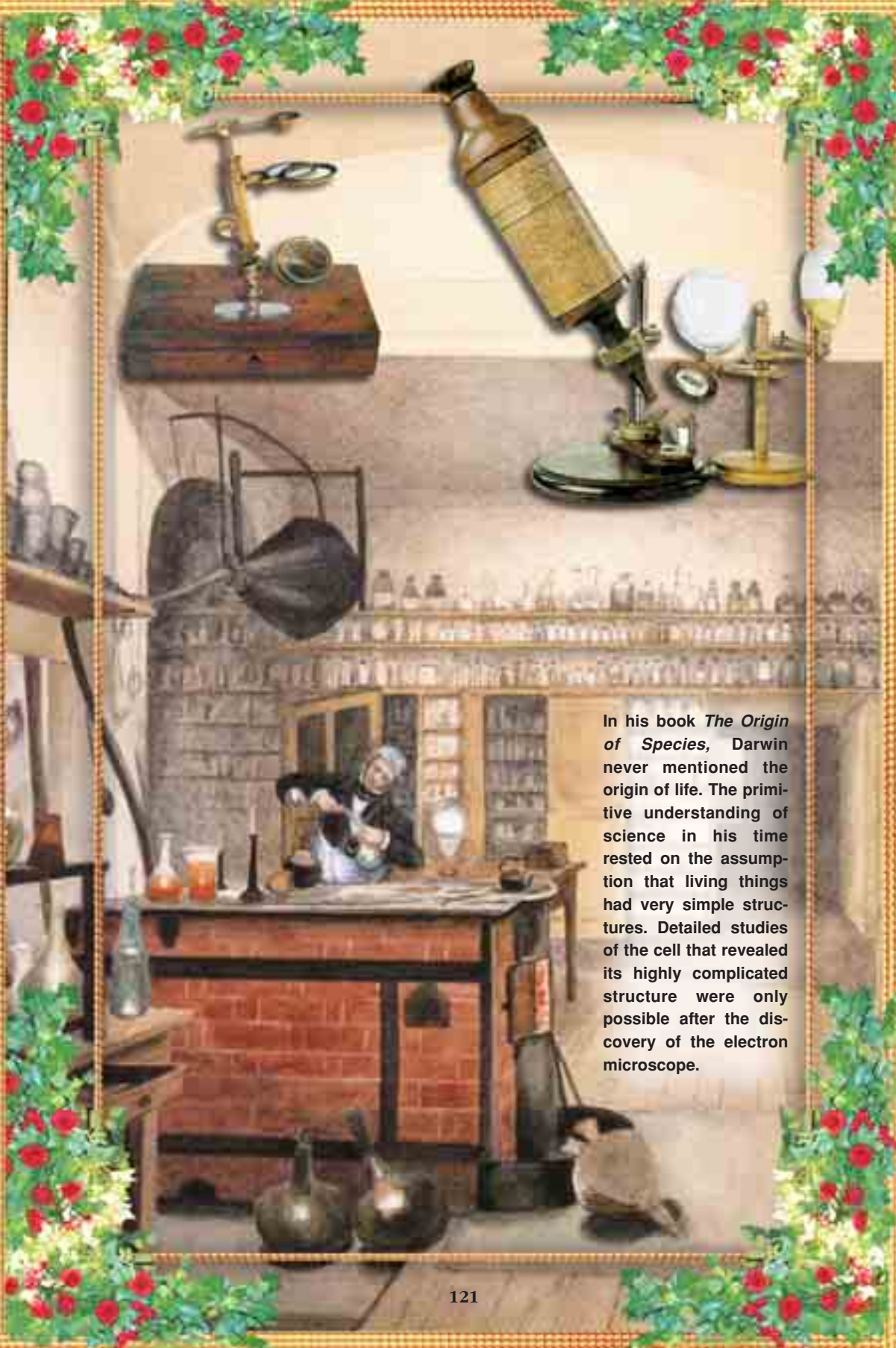

In his book *The Origin of Species*, Darwin never mentioned the origin of life. The primitive understanding of science in his time rested on the assumption that living things had very simple structures. Detailed studies of the cell that revealed its highly complicated structure were only possible after the discovery of the electron microscope.

and The Discovery Channel in broadcasting, and publications such as *Science*, *Nature*, *Scientific American*, and *New Scientist*.

The main starting point for this propaganda was set out in the slogan "Rejecting the theory of evolution means rejecting science." That is why these channels and publications, which claim to be among the world's most eminent and trustworthy scientific bodies, are never able to bring up scientific discoveries that disprove the theory of evolution. It is as if they had been programmed, literally by a hidden hand, to defend the theory of evolution under all circumstances and never allow the mention of a single word against it.

Not Avoiding Innovations and Shocks, and Being able to Lead The Way Toward Novelties, is a Sign of Superiority

History has always placed innovations in man's way. Those who are open to these innovations, who are able to think freely without being tied down to dogmatic, conservative ideas, and who do not shrink from the criticisms and attacks of those around them, have gone down in history as the vanguard of innovation, as makers of history itself. Dogmatic, conservative types, however, have remained trapped in their own superstitions. These organizations need to see that we are at a turning point in history, and exhibit a courageous and progressive character, without worrying about loss of prestige in evolutionist circles.

The fact that we are now at a most important turning point is so obvious that it cannot be ignored. The materialist thought that has dominated all fields over the last few hundred years, from science to art, and from philosophy to literature, is falling apart. The collapse of the theory of evolution, materialism's so-called scientific basis, is just accelerating the end of the dominion of materialist thought. Today, the entire scientific world is witnessing the rapid rise of the thesis of "Intelligent Design." It is now completely clear

that every living thing, and indeed every one of the trillions of cells that go to make up every living thing, possesses such a flawless, extraordinary design that this could never have come about by chance. The mind that accepts that a single letter "B" written on a piece of paper could never have come about by chance, must also accept the existence of "Intelligent Design" in living things. Accepting that fact means accepting the truths revealed by science, not rejecting them.

In any case, The History Channel and similar channels describe every day the flawless design in living things and show examples of marvelous creation. To claim that the living things which possess all these magnificent features are a miracle of evolution, in other words of blind coincidence, is both unscientific and irrational. Coincidence cannot create a miracle. In the same way that a camera, a television, or a picture cannot come about by chance, and cannot emerge of its own accord, neither can living things be the result of chance. It is evident that the theory of evolution conflicts with science and reason.

Evolutionists themselves are aware that chance is unable to account for life. The French zoologist Pierre Grassé admits:

Any living being possesses an enormous amount of "intelligence," very much more than is necessary to build the most magnificent of





cathedrals. Today, this "intelligence" is called information, but it is still the same thing. It is not programmed as in a computer, but rather it is condensed on a molecular scale in the chromosomal DNA or in that of every other organelle in each cell. This "intelligence" is the *sine qua non* of life. Where does it come from?... This is a problem that concerns both biologists and philosophers, and, at present, science seems incapable of solving it.¹

The reason why Grassé regards this as an unanswerable question is that he seeks the answer within the context of materialist prejudices. The truth, however, is very clear, and lies entirely outside materialist thought.

Our advice to the authorities at The History Channel is to have the courage to accept innovations and abandon their dogmas. They should put an end to showing the theory of evolution, which has cast a sort of magical spell over men's minds for the last 150 years, on our screens. That of course will represent an enormous shock, both for the channel and for evolutionists, but "shocks must not be avoided." Professor Michael Behe, an opponent of the theory of evolution and one of those who have not tried to avoid that shock, likewise advises his colleagues to do the same:

The resulting realization that life was designed by an intelligence is a shock to us in the twentieth century who have gotten used to thinking of life as the result of simple natural laws. But other cen-

turies have had their shocks, and there is no reason to suppose that we should escape them.²

Mankind managed to free itself from such dogmas as the idea that the earth was flat or at the center of the universe. It is also ridding itself of the materialist and evolutionist dogma that life emerged of its own accord, without being designed. The duty of true men of science and scientific bodies is to look at life and the origin of living things in an objective manner, compatible with the nature of science, by giving up their materialist preconceptions. The History Channel and the rest must not "avoid shocks," and must not support impossible scenarios by remaining attached to the outdated nineteenth-century materialist dogma.

Dangerous Atheist Propaganda Accompanies Evolutionist Propaganda

The program about the biography of Charles Darwin broadcast on The History Channel contains frequent elements of atheist propaganda, tries to portray science and religion as total opposites, and maintains the so-called superiority of Darwinism. The program presents Darwin as an atheist scientist and seeks to give the impression that the more he became interested in science, the further he moved from religion. The expressions employed in the documentary are particularly striking as they maintain according to the theory of evolution that man is also an animal, and that there is no such thing as an immortal spirit. This idea was against Christianity because if spirit did not exist, then the motivation for a better spiritual life would be abandoned. It is said in the documentary that after his daughter Emmy's death, Charles Darwin was sure that there was no final judgment after death.

Since the theory of evolution is portrayed as fact in the documentary, such baseless claims as "man is an animal, he has no spirit, spiritual matters are unimportant, and there is no such thing as final

**A DEFINITIVE REPLY
TO EVOLUTIONIST
PROPAGANDA**

judgment, the hereafter, or life after death" are thus suggested. Claims of this kind not only represent a threat to the society in which they are propagated, but are also unacceptable in a society largely consisting of believers. The History Channel's representatives must bear this fact in mind and reconsider their broadcasting policies in the knowledge that they are addressing communities most of whose members believe in God and religion.

The menace of atheist propaganda is evident. One of the main reasons behind the sudden collapse of the Soviet Union, and the reason why it was unable to survive, is that it spent many years utterly devoid of religious and spiritual values. Realizing, however, that those who sought salvation in the capitalist system would merely find themselves in another intolerable situation, Russia began to find its feet again after beginning to understand the importance of religion and spiritual matters. Atheism ruins a society's unity, harmony, peace, and social fabric. People who regard them-



Darwinism claims that living beings have evolved as a result of coincidences and by means of a struggle for life. This evil morality advises people to be egoistical, self-seeking, cruel and oppressive. The only possible solution that can save humanity from this benighted way of thinking is the widespread acceptance of the values of religion.

selves as animals and believe that they cease to exist after death have a tendency to turn towards all forms of wickedness, immorality, violence, and crime. It is a simple matter for such people to be convinced to kill, torture, and harm others, because they regard those others not as beings with spirits, but as animals. Forms of immorality such as falsehood, corruption, and theft increase rapidly in irreligious societies, and it becomes impossible to prevent them until the moral and religious structure of society is reinforced. Feelings of love, compassion, affection, and devotion entirely disappear in atheist societies, to be replaced by anger, violence, selfishness, neglect, and cruelty.

These are just a few of the tragedies which atheism inflicts on a society. If we consider one by one all the tragedies that every family that will go to make up irreligious generations will experience, we can clearly see what a grave menace atheism represents. That is why those who engage in atheist propaganda are playing with fire, and why the Darwinism-watch.com website contains frequent advice for those who "engage in atheist propaganda with their eyes closed." Such people are unable to see the evidence against the theory of evolution, and are also unable to calculate the serious damage they are causing society by their defense of the theory.

Conclusion

Like those who hundreds of years ago maintained that the earth was flat, The History Channel and the other bodies in question are also making totally irrational claims, and they must stop doing this under a false scientific mask. It is they who will emerge the winners if they sincerely defend the truths that science now reveals.

1. Pierre Grassé, *The Evolution of Living Organisms*, 1977, p. 168.
2. Michael Behe, *Darwin's Black Box*, New York, The Free Press, 1996, pp. 252-253.

***NEW SCIENTIST'S LATEST
MYTH: "HICCUPS ARE A
LEGACY FROM EVOLUTION"***

An article in the February 8, 2003, edition of the British magazine *New Scientist* carried speculation by an evolutionist researcher called Christian Straus, who suggested that hiccupping in human beings was a feature left over from evolution. He claimed there was a similarity between respiration in frogs and hiccupping, and suggested that this might be a feature stretching from 370 million years ago to modern man. However, Strauss offered not one piece of evidence to back this claim up, and merely engaged in speculation along the lines of "it might possibly be." In fact, Allan Pack, an expert in respiratory neurobiology at the University of Pennsylvania, stated that the claim was "very tough to prove."¹

This claim is therefore no evidence for the theory of evolution. It merely consists of mental gymnastics, in other words speculation, in a manner compatible with the theory of evolution by a number of people who have unreservedly accepted the theory beforehand. Such speculation is valueless, since their starting point—the theory of evolution—is itself invalid.

The way that some media organizations have unquestioningly reported such speculation, and even portrayed it as proven fact, is nothing but an indication of their superficiality, ignorance, and prejudice. The sensationalist style used in these

The article in *New Scientist* includes many misleading expressions and Darwinist claims. Yet it lacks any substantial evidence to support these claims.

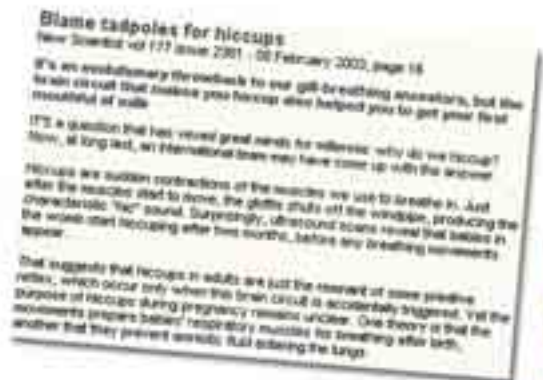

media outlets is immediately evident upon examining the reports. The blatant use of descriptions such as "souvenir of our ancestors" or "legacy" in their headlines is a sign of this.

The reception given the story in the newspapers is thus rather exaggerated. Despite the fact that Straus offered no evidence at all for his claim, and the fact that the claim has not been accepted by other scientists, nevertheless, it was carried on the dailies' front pages as if it were a fact definitively proving evolution.

This story about "hiccupping" is just one example among many. Daily newspapers all over the world are quite capable of carrying stories, including ones about evolution, on their front pages without ever enquiring into their scientific background. Other recent newspaper headlines, such as "Our ancestors were microbes," "We came from Mars," "The dinosaur flew," and "Man's ancestors were anteaters," are all products of the same sensationalist journalism. These dailies and *New Scientist* magazine ignore the fact that science has undermined the theory of evolution, and portray evolutionist gaffes which lack any scientific value whatsoever as if they were proven fact.

1. *New Scientist*, vol 177 issue 2381 - 08 February 2003, p. 16

Praise be to God, to Whom everything in the heavens and everything in the earth belongs. Praise will be His in the Hereafter. He is the Wise, the Informed. He knows what penetrates the earth and what issues from it, and what falls down from the sky and what soars up into it. He is the Most Merciful, the Ever-Forgiving.
H (Qur'an, 34: 1-2)

The image is a composite graphic. At the top, a decorative arch of green leaves and red flowers frames the scene. Below this, a photograph of a coastal bay is shown, featuring several white sailboats on the water and a sandy beach in the distance. The bay is framed by a wooden border. In the foreground, a white stone balustrade with decorative balusters is visible. Below the balustrade, there is a dense arrangement of red and white tulips, also framed by a wooden border and floral decorations.

**NEW SCIENTIST'S "EVOLUTION
WITH CLIMATE" ERROR**

The February 22, 2003, edition of *New Scientist* magazine carried an article called "Squirrels evolve as the world heats up." The story maintains that for the first time a mammal has been shown to be evolving in order to adapt to climate changes. It is described in *New Scientist* how some living things migrate to cold, polar regions in order to avoid the effects of global warming. The claim is then made that instead of migrating, squirrels have genetically adapted to climate changes. Yet, *New Scientist* is in error: there is no evolution in the changes of which it speaks.

The species of squirrel used in the study is the red squirrel, which lives in Canada. University of Alberta biologist Andrew McAdam and his colleagues spent 10 years studying the time of the year at which squirrels give birth and recording their findings. The researchers observed three to four squirrel generations during the 10-year period, and stated that present-day squirrels give birth on average 18 days earlier than their great, great-grandmothers. In this way, squirrels react to climatic warming by giving birth an average of six days earlier a year.

Evolutionists regard this change as "evolution" and maintain that this can be seen not just in the squirrels' behavior, but also in their genetic material. Yet, this claim is not a valid one, because the researchers have not directly observed any genetic change. The basis of this claim is an analytical method based on statistics. The *New Scientist* article says:

The researchers used a statistical technique to work out how much of the change is down to evolution and how much is due to individual flexibility. They calculated the normal variation in birth dates for each generation and then identified squirrels that were giving birth much earlier than average. If the parents had the same trait, it was likely to have been inherited. The technique, which is commonly used in agriculture, attributes about 15 percent of the shift towards early birth to evolution.

These statistical analyses provide no evidence of evolution. The

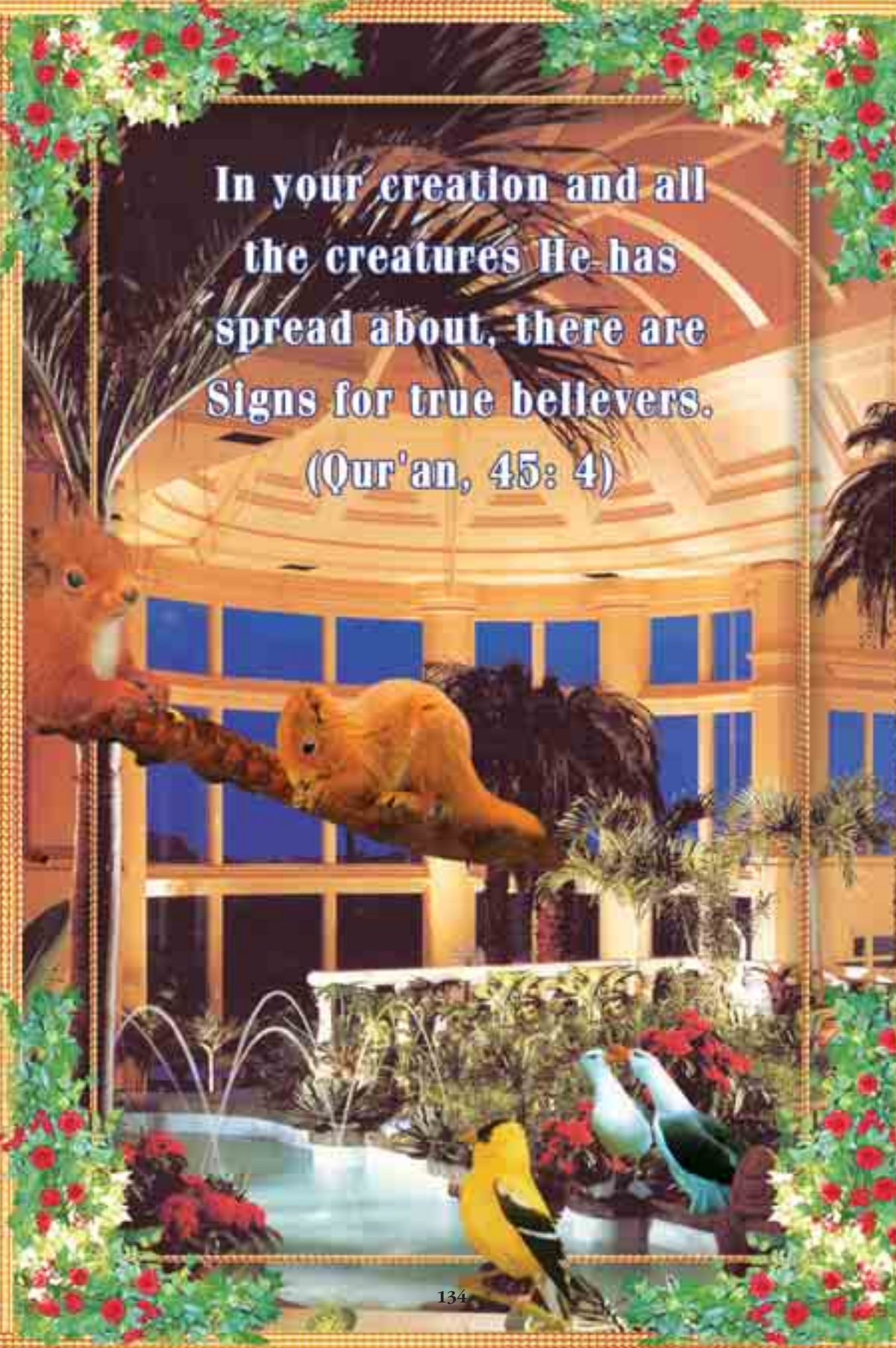
A vibrant indoor garden scene. In the foreground, a yellow and black bird is perched on a ledge. To its right, two blue and white birds are perched on a ledge. In the background, a large fountain with multiple jets of water is surrounded by lush greenery and red flowers. A large palm tree is visible in the center. The scene is framed by a decorative border of red and white flowers. The text is centered in the upper half of the image.

**In your creation and all
the creatures He has
spread about, there are
Signs for true believers.
(Qur'an, 45: 4)**

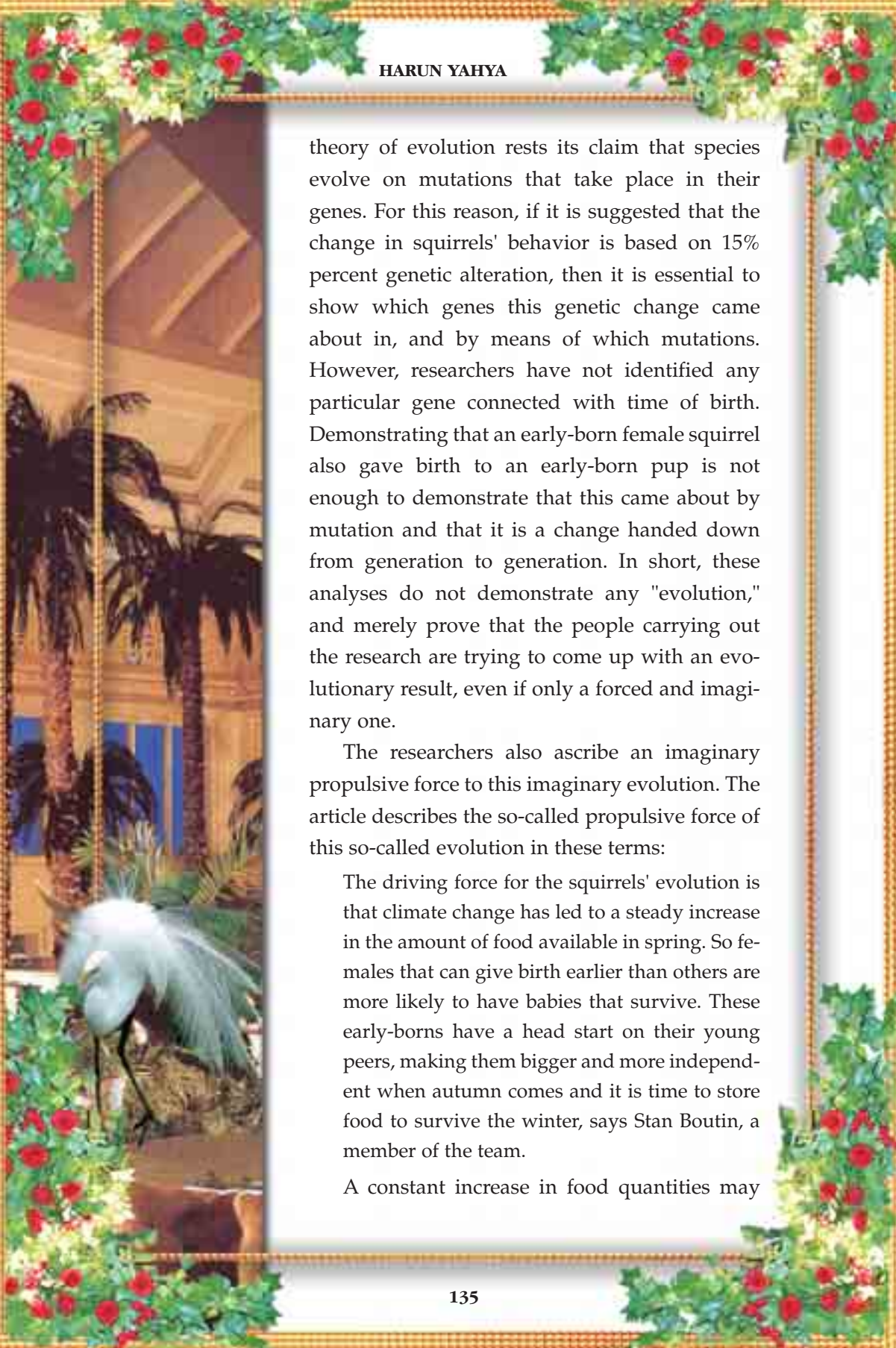

theory of evolution rests its claim that species evolve on mutations that take place in their genes. For this reason, if it is suggested that the change in squirrels' behavior is based on 15% percent genetic alteration, then it is essential to show which genes this genetic change came about in, and by means of which mutations. However, researchers have not identified any particular gene connected with time of birth. Demonstrating that an early-born female squirrel also gave birth to an early-born pup is not enough to demonstrate that this came about by mutation and that it is a change handed down from generation to generation. In short, these analyses do not demonstrate any "evolution," and merely prove that the people carrying out the research are trying to come up with an evolutionary result, even if only a forced and imaginary one.

The researchers also ascribe an imaginary propulsive force to this imaginary evolution. The article describes the so-called propulsive force of this so-called evolution in these terms:

The driving force for the squirrels' evolution is that climate change has led to a steady increase in the amount of food available in spring. So females that can give birth earlier than others are more likely to have babies that survive. These early-borns have a head start on their young peers, making them bigger and more independent when autumn comes and it is time to store food to survive the winter, says Stan Boutin, a member of the team.

A constant increase in food quantities may

give rise to increasingly large squirrels as autumn approaches. Yet, this cannot be a propulsive force of evolution, because there have been no findings to show that the squirrels that this force is alleged to influence have undergone a mutation that has provided them with an advantage. There can be no talk of genetic change in the absence of mutation, and no talk of evolution without genetic change. If it is suggested that there is a propulsive force bringing about evolution in this example, then it must be shown which mutations apply. Yet, as we have made clear above, these mutations exist only in the minds of the researchers themselves.

Conclusion

This change seen in squirrels is not an example of evolution. Living things possess the ability to adapt to climatic conditions. This is well known, and it has been proven many times that it cannot bring about evolution. The statistical analyses put forward for the claim that climatic changes led to genetic change in squirrels have no evolutionary significance. Until the gene which controls this behavioral alteration and the mutations that took place in it during this 10-year period are identified, the claim can go no further than being a fairy tale.

It remains to say that even if there were a mutation that altered the time squirrels give birth, that would still not constitute proof of evolution. The theory requires mutations to produce new genetic information, new organs, and new biochemical structures. In other words, mutations must bring about "vertical development." Even if it had to do with a mutation, a change in the time at which squirrels give birth would not mean the emergence of a new organ, a new system, or a new biochemical structure. It would only be a "horizontal variation," for which reason it could not be described as "evolution."

**Travel about the earth and see how He brought creation out of nothing. Then later God will bring about the next existence. God has power over all things.
(Qur'an, 29: 20)**





**PAUL DAVIES' DESPERATE
CASE FOR A "MULTIVERSE"**

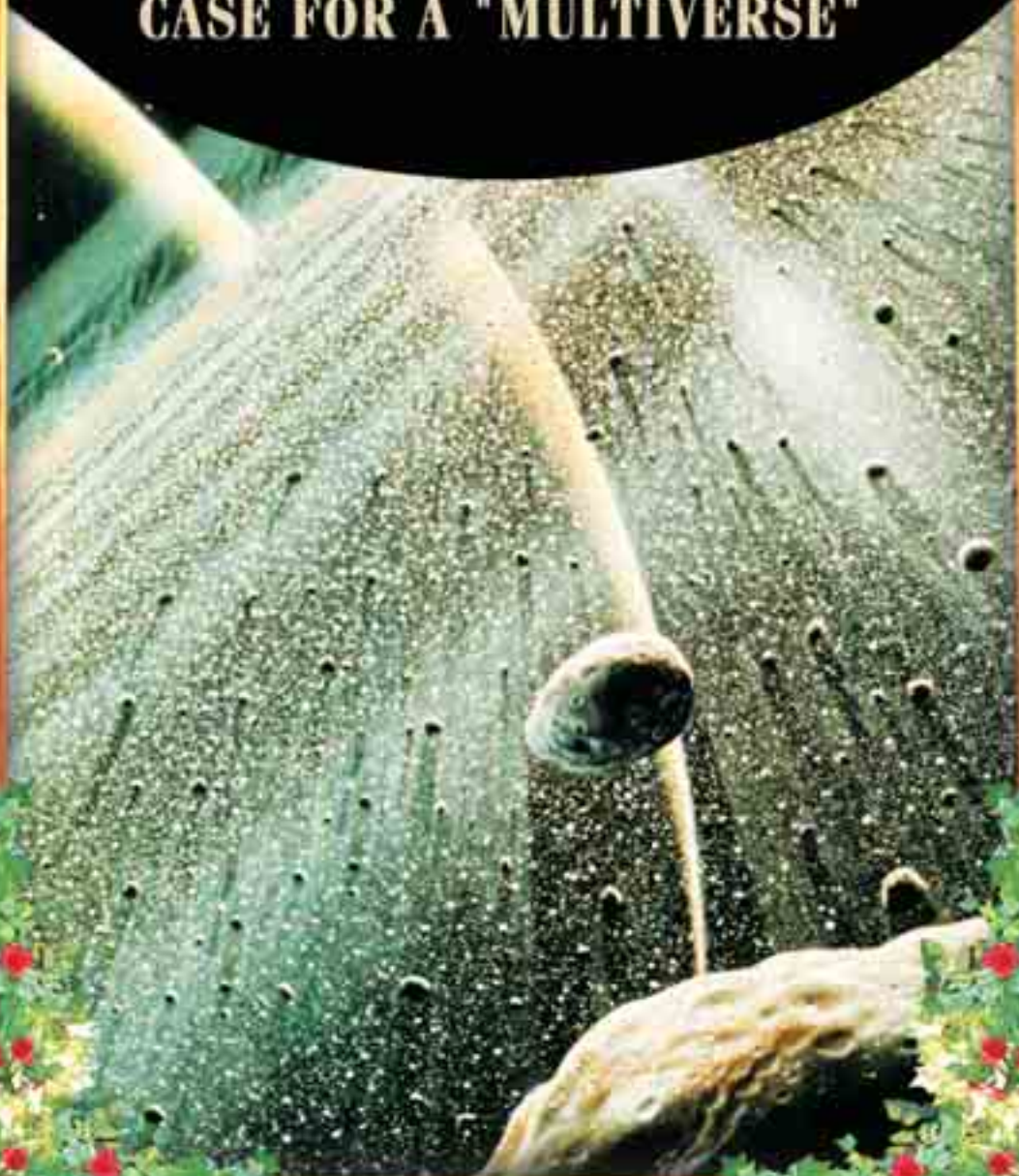

In its April 12, 2003, edition, *The New York Times* carried an article by the famous astrophysicist Paul Davies entitled "A Brief History of the Multiverse." In this article, Prof. Davies attempts to defend the claim that there may be an infinite number of universes, and that our universe just happened to be suitable for life, which is the latest argument in which materialist thinkers have sought refuge in the face of the finely tuned design in the universe.

We first need to briefly set out why materialists developed such an argument. For thousands of years, the divine religions and philosophies that accept the existence of God have maintained that there is purpose and design in the universe, whereas materialists—those who claim that nothing exists apart from matter—have rejected the existence of purpose and design. A series of astronomical and physical discoveries in the twentieth century, however, revealed that the design in the universe was so clear as to be undeniable. These discoveries revealed that at the moment the universe began, all variables—from the speed of the Big Bang to the strength of the four fundamental forces, from the structure of the elements to that of the Solar System in which we live—were exactly what was required to support life. This tremendous discovery, which scientists in the 1970s announced and described as the Anthropic Principle, clearly invalidated the materialist argument for non-design.

In his article in *The New York Times*, Paul Davies summarizes this fact and admits the inevitable conclusion; the existence of God:

Why is nature so ingeniously, one might even say suspiciously, friendly to life? What do the laws of physics care about life and consciousness that they should conspire to make a hospitable universe? It's almost as if a Grand Designer had it all figured out.



Paul Davies

However, although regarding the design in the universe as proof of the existence of God, Prof. Davies rejects this fact. In order to account for the origin of the design in the uni-



Among His Signs is that
heaven and earth hold
firm by His command.
(Qur'an, 30: 25)

verse, he resorts to the multiverse theory, the last refuge, as we have already seen, of the materialists.

The Multiverse Theory

According to this theory, the universe we live in may be only one of an infinite number of universes comprising a very much larger "multiverse." In the materialists' view, it is quite normal for one or some of so many universes to be suited to life.

Yet is there any scientific evidence to support this theory?

No. None at all. It is nothing more than speculation, a scenario cast upon the waters.

The interesting aspect of Prof. Davies' article is that he attempts to give the impression that there is in fact a large quantity of important evidence in favor of the multiverse theory. The newspaper's spot caption summarizing the article is directed to just that end:

This idea of multiple universes, or multiple realities, has been around for centuries. The scientific justification for it, however, is new.

Anyone seeing these introductory sentences without going on to read the whole text may well imagine that the multiverse theory is based on concrete scientific proof and that Prof. Davies' article goes on to mention it. However, quite the opposite is the case: There is no such evidence and in fact the author says not a word about this new scientific evidence, which he would happily speak of, if it existed.

On the contrary, there are admissions in Prof. Davies' article that the multiverse theory is only speculative. According to Prof. Davies, the multiverse theory has been arrived at "by imagining." Moreover, he says in reference to the theory that "credibility reaches a limit" and that it "more and more must be accepted on faith."

In short, Prof. Davies' and all other materialists' interest in the multiverse theory stems from personal preference rather than scientific proof. The starting point of that personal preference is their unwillingness to accept that the universe is the work of a Creator. Paul Davies states this fact in his article, claiming that any account based on saying "God made it that way" is not "satisfying" for a scientist.

The Aim of Materialistic Science

This question of "satisfaction" or the lack thereof is actually the starting point of materialistic science. This view of science takes as its aim the denial of the existence of God in accounting for nature and the universe. As Benjamin Wiker has set out in considerable detail in his important book, *Moral Darwinism: How We Became Hedonists*, this intention has always lain behind the attempt to build a science that ignores the existence of God, which stretches from Epicurus to Charles Darwin and contemporary materialists. Materialists are desperately trying to develop and prove theories that deny the existence of God, not because science demands them, but because their worldviews and philosophies do.

Science itself, on the other hand, insistently and powerfully reveals the truth that materialists seek to ignore—that the universe is full of evidence of the Creator Who created it from nothing and so marvellously designed all its content.

Proofs of the Existence of God

The multiverse theory is one of the theories put forward in order to deny that truth, and is very definitely unfounded. The lack of any scientific evidence for the theory, as Prof. Davies himself admits, reduces it to the level of a belief—an unsubstantiated belief. Moreover, it is deceptive for materialists to put forward such objections as "you believe that God created the universe, we believe in many universes"—in other words, to suggest that there is a sort of "equivalence" here—because:

The rational explanation for the design in the universe is an intelligent designer. When you see a statue, you realize that there must also be a sculptor. An argument such as "Since there are infinitely many stones in the universe, this one just happened to take shape by chance," is of course quite irrational. In line with the logical rule known as Ockham's razor, which states that the simplest ex-

God created the
heavens and the earth
with truth. There is
certainly a Sign in
that for the believers.
(Qur'an, 29: 44)



**It is God Who made the earth a
stable home for you and the sky a
dome, and formed you, giving you
the best of forms, and provided you
with good and wholesome things.
That is God, your Lord. Blessed be
God, the Lord of all the worlds.
(Qur'an, 40: 64)**

planation of something is the one that ought to be accepted, the origin of the fine tuning in the universe is to be explained in terms of design rather than chance. (For details, see Harun Yahya's *The Creation of the Universe*, Al-Attique Publishers, Canada, 2001.)

There is a great deal of scientific evidence for the existence of God beyond just the fine-tuning in the universe. Like other materialists, Paul Davies believes that Darwinism has resolved the problem of the origin of living things, or else consoles himself with that assumption. The fact is, however, that Darwinism is now a discredited theory, and that it has been powerfully proven that there is intelligent design in the origin of living things. This is a scientific demonstration of the fact that, as well as creating the universe with flawless balances and design, God also intervenes in the universe which He has created. (For further details, see Harun Yahya's *Darwinism Refuted*.)

There is considerable evidence for the existence of God beyond the positive sciences. Discoveries in many areas such as human psychology, the evidence for the existence of the human soul, the divine texts, and the miraculous information in the Qur'an, the last divine text, demonstrate the existence of God and the fact that He created man and showed him the true path by way of religion. (See Harun Yahya's article "The Fall of Atheism," www.harunyahya.com/70the_fall_of_atheism_sci4.php.)

Materialists, on the other hand, are unable to find any other solution in the face of the increasingly powerful evidence mounting against them than to dream up new speculative theories—just like Paul Davies, who sets out by speaking of "new evidence for the multiverse theory," but who is unable to offer any evidence at all.

What Prof. Davies needs to do is to re-evaluate the scientific findings regarding the origin of the universe, not in the hope of finding a "satisfying" conclusion from the point of view of materialist prejudice, but in the hope of finding the ultimate truth. Then, he might see the truth of creation, which has been under his very nose all along, and finally grasp the existence of God, his own Creator and the Creator of all mankind.



**EVOLUTIONARY TALL TALES
FROM THE BBC -I-**

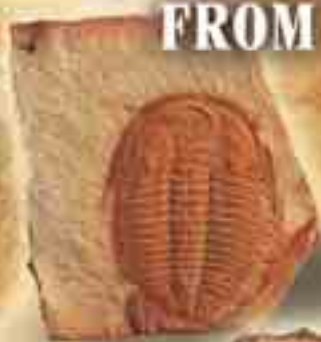

The documentary *The Human Body*, prepared by the BBC is full of intense propaganda intended to impose the theory of evolution on viewers. Yet this propaganda served no other purpose than to prove that the theory of evolution is nothing but an unscientific myth.

The documentary introduces the human body, and describes the so-called evolution of man in a fairy tale manner, offering the viewer no evidence whatsoever. Intended as thoroughgoing propaganda, the documentary actually demonstrates how devoid of scientific support the theory of evolution really is. What follows is a scientific reply to the errors in the documentary:

BBC's Bacteria Myth

BBC's evolutionary tall tales begin with the sentence that there were first of all bacteria in the primitive world, and plants and animals later evolved from these bacteria. The fact is, of course, that the expression "there were bacteria in the primitive world" is meaningless because the problem is how those bacteria came into being. Those who prepared this documentary on BBC might have thought they could gloss over this crucial question on the assumption that their viewers would adopt a superficial view of the matter such as "those bacteria must probably have come into being by themselves." (Even worse, they themselves might hold just such a view.) In truth, however, even the origin of the very simplest bacterium represents a major difficulty for the theory of evolution, one that cannot be glossed over with the words just mentioned.

The origin of bacteria is a problem for the theory of evolution because the theory maintains that life on the primitive earth came about from random chemical reactions. Yet even the simplest bacterium contains such a complex organization and information that these can never be accounted for by any chemical reaction.

Let us examine this information: A bacterium has around 2,000

A DEFINITIVE REPLY
TO EVOLUTIONIST
PROPAGANDA



In this picture, magnified 15,000 times, can be seen the DNA molecule of a bacterium which has been exposed to special intervention. There are 4 million base pairs in this bacterium's DNA, and if this DNA were stretched out flat it would be 1.5 mm long, or 1,000 times longer than the cell itself. Just the way in which such a complex structure is squeezed into such a restricted space shows the fine detail in God's art of creation.

tioning of the bacterium's entire system. A deficiency in a bacterium's genetic code would mean damage to the working system, and therefore death.

Robert Shapiro, a professor of chemistry at New York University, calculated the probability that all 2,000 of the different types of proteins that it takes to make up even a simple bacterium could have come into being completely by chance. According to Shapiro, the probability is one in $10^{40,000}$.² (That number is "1" followed by forty thousand zeros and it has no equivalent in the universe.)

Chandra Wickramasinghe, a professor of applied mathematics and astronomy at the University of Cardiff, commented on Shapiro's result:

genes, each gene consisting of up to 1,000 letters (codes). This means that the information in its DNA must be at least 2-million letters long. That, in turn, means that the information contained in the DNA of just one bacterium is equivalent to 20 novels of 100,000 words each.¹ That being the case, it is quite impossible for a single bacterium to come about by chance or to evolve as the result of chance effects. Any chance intervention to a structure containing information on such a scale would damage the func-

... One to a number with $10^{40,000}$ noughts after it...It is big enough to bury Darwin and the whole theory of evolution. There was no primeval soup, neither on this planet nor on any other, and if the beginnings of life were not random, they must therefore have been the product of purposeful intelligence.³

Sir Fred Hoyle, the British mathematician and astronomer, has this to say about these figures:

Indeed, such a theory [that life was assembled by an intelligence] is so obvious that one wonders why it is not widely accepted as being self-evident. The reasons are psychological rather than scientific.⁴

It is therefore impossible for even the simplest bacterium to have come about by chance, as evolutionists claim. In fact, the theory of evolution is even unable to account for the emergence of just one of the 2,000 kinds of protein that go to make up a simple bacterium. For that reason, saying "first there were bacteria, and plants and animals later developed from bacteria" is a huge deception, devoid of any scientific foundation. Those who prepared the BBC documentary must in any case be aware of this, since they avoided the subject of how the first bacterium came into being, simply beginning their tale with "bacteria that somehow came into being."

Below can be seen a single-celled protist, and to the side are shown nerve cells with their complex structure. These cells are all marvels of design.

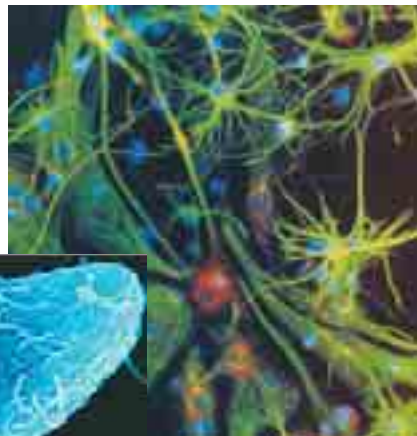

Furthermore, evolutionists have not one shred of evidence for their evolutionary fantasy; no intermediate form between bacteria and the first plants and animals exists, and they themselves admit the fact. One such evolutionist is Professor Ali Demirsoy, a prominent Turkish defender of evolution, who confesses:

One of the most difficult stages to be explained in evolution is to scientifically explain how organelles and complex cells developed from these primitive creatures. No transitional form has been found between these two forms. One- and multicelled creatures carry all this complicated structure, and no creature or group has yet been found with organelles of a simpler construction in any way, or which are more primitive. In other words, the organelles carried forward have developed just as they are. They have no simple and primitive forms.⁵

The Mistaken Idea that Bacteria Evolved as their Environment Changed

It was suggested in the BBC documentary in question that bacteria were gradually exposed to change, as a result of which more complex life forms emerged. This is nothing but a work of the imagination, without any scientific foundation. Bacteria have very short life spans, and a single scientist can therefore observe many generations of them. Evolutionists have thus subjected bacteria to countless mutations for many years, but no evolution has ever been observed in a single one. Pierre-Paul Grassé, one of France's best-known zoologists, the editor of the 35-volume *Traité de Zoologie*, and former president of the Académie des Sciences, writes the following about this bacterial immutability which invalidates evolution:

Bacteria... are the organisms which, because of their huge numbers, produce the most mutants. [B]acteria... exhibit a great fidelity to their species. The bacillus *Escherichia coli*, whose mutants have been studied very carefully, is the best example. The reader will agree that it is surprising, to say the least, to want to prove evolution and

to discover its mechanisms and then to choose as a material for this study a being which practically stabilized a billion years ago! What is the use of their unceasing mutations, if they do not [produce evolutionary] change? In sum, the mutations of bacteria and viruses are merely hereditary fluctuations around a median position; a swing to the right, a swing to the left, but no final evolutionary effect.⁶

In short, if mutations brought about evolution in bacteria, then examples of this should have been seen in the laboratory. Yet, in fact, quite the reverse is the case.

The Mistaken Idea that Small Changes Gradually Led to Evolution

In the documentary, space is devoted to evolutionists' traditional claims, and it is maintained that over billions of years small changes occurring in organisms combined and led to new species. There is no scientific foundation for such a claim.

The "one by one, small, imperceptible changes" in question are mutations, since mutations are the only mechanism of change the theory of evolution can offer.

Mutations are corruptions and

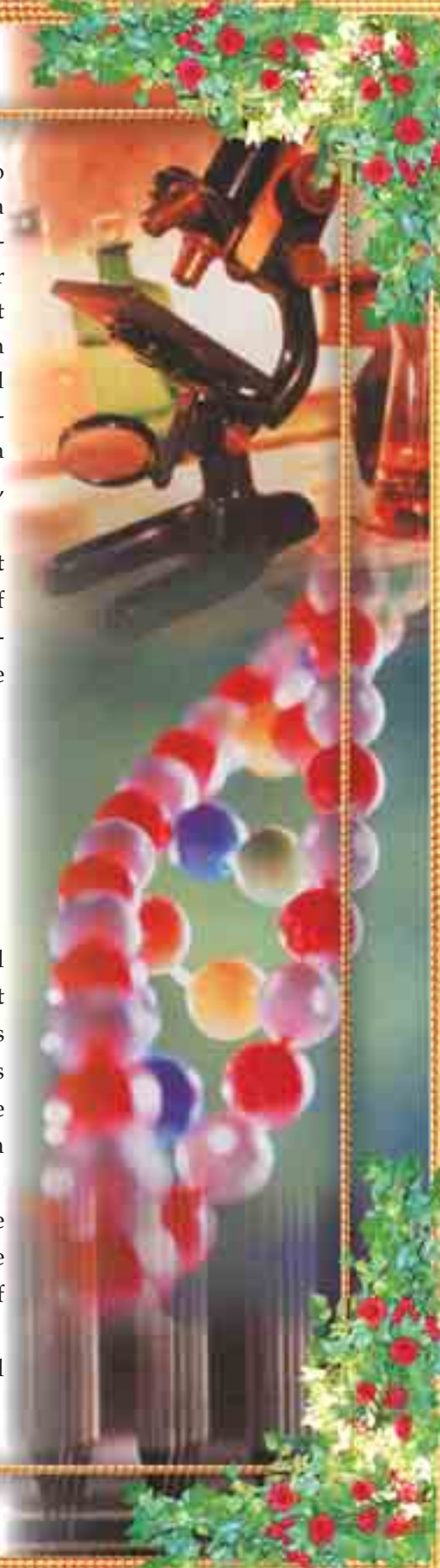

**A DEFINITIVE REPLY
TO EVOLUTIONIST
PROPAGANDA**

changes in living things' genetic codes brought about by various external factors such as radiation and chemical effects. The genetic code of a healthy living thing possesses a flawless order and sequence. Ninety-nine percent of mutations damage DNA (the other 1 percent having no effect). Mutations tear apart, destroy, or confuse the DNA sequences in which a living thing's genetic code is recorded—that is, they eliminate existing information. Hiroshima, Nagasaki, and Chernobyl are just a few contemporary examples of the damaging effect radiation has on genes. As a result of the genetic mutations caused by these tragedies, countless people and other living things lost their lives, many were crippled, and handicapped individuals were born in subsequent generations.

The American geneticist B.G. Ranganathan describes the damage mutations do to living organisms in these terms:

First, genuine mutations are very rare in nature. Secondly, most mutations are harmful since they are random, rather than orderly changes in the structure of genes; any random change in a highly ordered system will be for the worse, not for the better. For example, if an earthquake were to shake a highly ordered structure such as a building, there would be a random change in the framework of the building, which, in all probability, would not be an improvement.⁷



That is why there is no mechanism in nature that might bestow minute, imperceptible beneficial changes on living things. The reason why BBC glosses over this subject with superficial accounts and avoids going into any detail on it stems from the fact that it is only too well aware how that change actually came about.

The Mistaken Idea that Species Evolved from One Another

According to evolutionists, all living things developed from one another. A previously existing species turned into another one over time, and all the species eventually emerged in this manner. According to the theory, this transition occupied a period of hundreds of millions of years, and happened in stages.

Yet if these evolutionists' claims were true—if, in other words, fish had evolved into reptiles, reptiles into birds, etc., as BBC



A DEFINITIVE REPLY
TO EVOLUTIONIST
PROPAGANDA

claims—then countless "intermediary species" should also have emerged and lived during this transformation period.

For instance, some half-fish/half-reptiles should have lived in the past that had acquired reptilian traits in addition to the fish traits they already had. Or there should have existed some reptile-birds with novel bird traits in addition to their pre-existing reptilian traits. If such creatures in a transitional process had existed, they would have been crippled, handicapped, and defective organisms.

Evolutionists refer to these imaginary creatures, which they believe to have lived in the past, as "transitional forms." If such animals had really existed, there should have been millions and even billions of them. More importantly, the remains of these strange creatures should be present in the fossil record. The number of these transitional forms should have been even greater than the present animal species and their remains should be found all over the world. This is a fact which Darwin also accepted.

Even Darwin himself was aware of the absence of such transitional forms. But he hoped that they would be found in the future. Despite his hopefulness, he realized that the biggest stumbling-block to his theory was the missing transitional forms. Therefore, in his book *The Origin of Species* he wrote the following in the chapter "Difficulties of the Theory":

...Why, if species have descended from other species by fine gradations, do we not every-



Graeophonus -
Scorpion fossil from the
Carboniferous Period.



Fossil of *betulites* leaf
from the Cretaceous
Period forests.



A fossil frog from
the Mesozoic era.

where see innumerable transitional forms? Why is not all nature in confusion, instead of the species being, as we see them, well defined?... But, as by this theory innumerable transitional forms must have existed, why do we not find them embedded in countless numbers in the crust of the earth?... But in the intermediate region, having intermediate conditions of life, why do we not now find closely-linking intermediate varieties? This difficulty for a long time quite confounded me.⁸

Despite evolutionists' best efforts, no transitional forms have yet been uncovered. All scientific findings have shown that, contrary to the beliefs of evolutionists, life appeared on earth all of a sudden and fully-formed. A famous British paleontologist, Derek V. Ager, admits this fact even though he is an evolutionist:

The point emerges that if we examine the fossil record in detail, whether at the level of orders or of species, we find—over and over again—not gradual evolution, but the sudden explosion of one group at the expense of another.⁹

Another evolutionist paleontologist Mark Czarnecki comments as follows:

A major problem in proving the theory has been the fossil record... This record has never revealed traces of Darwin's hypothetical intermediate variants—instead species appear and disappear abruptly, and this anomaly has fuelled the creationist argument that each species was created by God.¹⁰



**Fossil of the
Williamsonia flower
from the Mesozoic era.**



Fossil trilobite



**Leaf fossil of the
Liquidambar tree which
also exists today.**

So, since the fact is that no intermediary forms have ever been found, and that this represents a serious problem for the theory of evolution, how is it that BBC and other like-minded evolutionist media are able to continue propagating the myth that "fish became reptiles and reptiles became birds?" The answer to this question is given in an article in the journal *Science*:

A large number of well-trained scientists outside of evolutionary biology and palaeontology have unfortunately gotten the idea that the fossil record is far more Darwinian than it is. This probably comes from the oversimplification inevitable in secondary sources: low-level textbooks, semipopular articles, and so on. Also, there is probably some wishful thinking involved. In the years after Darwin, his advocates hoped to find predictable progressions. In general these have not been found yet the optimism has died hard, and some pure fantasy has crept into textbooks.¹¹

As revealed in *Science*, behind BBC's unscientific claim lie such factors as "not being unbiased and imagining." BBC presented evolutionary fantasies to the viewer like a fairy tale, talking about "bacteria turning into human beings," and "reptiles that were birds and fish that walked on land," as if it were talking about "the prince who turned into a frog."

Why Does BBC Still Portray Haeckel's Deceptions as if they were Science?

Human and fish embryos are compared in the BBC documentary *The Human Body*, and the theory of "recapitulation," which ceased to be part of scientific literature years ago, is still portrayed as a scientific fact. The term "recapitulation" is a condensation of the dictum "ontogeny recapitulates phylogeny," put forward by the evolutionary biologist Ernst Haeckel at the end of the nineteenth century.

This theory of Haeckel's postulates that living embryos re-experience the evolutionary process that their pseudo-ancestors under-

went. He theorized that during its development in its mother's womb, the human embryo first displayed the characteristics of a fish, and then those of a reptile, and finally those of a human.

It has since been proven that this theory is completely bogus. It is now known that the "gills" that supposedly appear in the early stages of the human embryo are in fact the initial phases of the middle-ear canal, parathyroid, and thymus. That part of the embryo that was likened to the "egg yolk pouch" turns out to be a pouch that produces blood for the infant. The part that was identified as a "tail" by Haeckel and his followers is in fact the backbone, which resembles a tail only because it takes shape before the legs do.

These are universally acknowledged facts in the scientific world, and are accepted even by evolutionists themselves. Two leading neo-Darwinists, George Gaylord Simpson and W. Beck, have admitted: "Haeckel misstated the evolutionary principle involved. It is now firmly established that ontogeny does not repeat phylogeny."¹² In an article published in *American Scientist*, we read:

Surely the biogenetic law is as dead as a doornail. It was finally excoriated from biology textbooks in the fifties. As a topic of serious

The invalidity of Haeckel's fictitious claims emerged with scientific evidence. The development of the human embryo inside the mother's womb is one of the greatest miracles in the world.

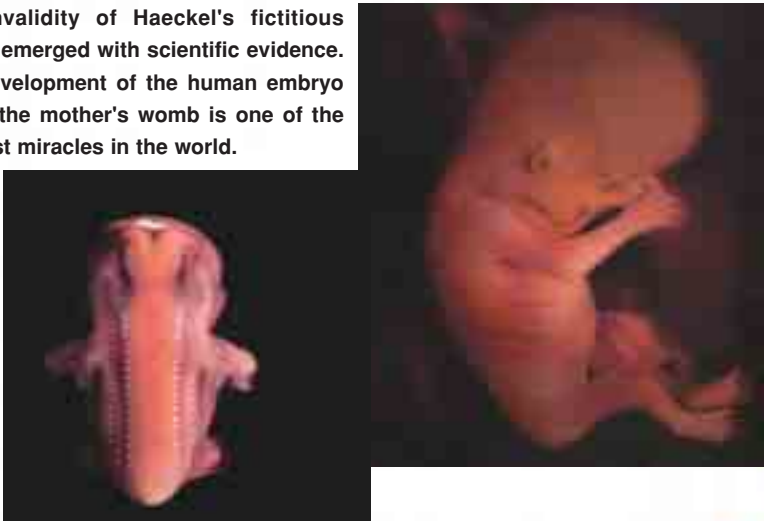

A DEFINITIVE REPLY
TO EVOLUTIONIST
PROPAGANDA

theoretical inquiry it was extinct in the twenties...¹³

The following was written in an article in *New Scientist*, dated October 16, 1999:

[Haeckel] called this the biogenetic law, and the idea became popularly known as recapitulation. In fact Haeckel's strict law was soon shown to be incorrect. For instance, the early human embryo never has functioning gills like a fish, and never passes through stages that look like an adult reptile or monkey.¹⁴

Another interesting aspect of "recapitulation" was Ernst Haeckel himself, a faker who falsified his drawings in order to support the theory he advanced. Haeckel's forgeries purported to show that fish and human embryos resembled one another. When he was caught out, the only defense he offered was that other evolutionists had committed similar offences:

After this compromising confession of 'forgery' I should be obliged to consider myself condemned and annihilated if I had not the consolation of seeing side by side with me in the prisoner's dock hundreds of fellow-culprits, among them many of the most trusted observers and most esteemed biologists. The great majority of all the diagrams in the best biological textbooks, treatises and journals would incur in the same degree the charge of 'forgery,' for all of them are inexact, and are more or less doctored, schematised and constructed.¹⁵



Haeckel himself was forced to admit that his drawings from the end of the 19th century were fraudulent.

In the September 5, 1997, edition of the well-known scientific journal *Science*, an article was published revealing that Haeckel's embryo drawings were the product of a deception. The article, called "Haeckel's Embryos: Fraud Rediscovered," had this to say:

The impression they [Haeckel's drawings] give, that the embryos are exactly alike, is wrong, says Michael Richardson, an embryologist at St. George's Hospital Medical School in London... So he and his colleagues did their own comparative study, reexamining and photographing embryos roughly matched by species and age with those Haeckel drew. Lo and behold, the embryos "often looked surprisingly different," Richardson reports in the August issue of *Anatomy and Embryology*.

In short, despite its having emerged as early as 1901 that Haeckel's drawings were counterfeit, defenders of the theory of evolution such as BBC portray this theory as if it were scientific fact and attempt to keep the evolution deception alive.

Empty Words and Statements Intended to "Bewitch" the Viewer

"The miracle of evolution;" "evolution accomplished this extraordinary transformation;" "the human body shaped by evolution." Expressions such as these are frequently encountered in evolutionist sources. BBC often uses them, trying to inculcate the idea of "the miracle of evolution" alongside striking and colorful images. When these expressions of BBC's are examined closer, however, it can be seen that they are hollow, devoid of any scientific proof and actually state and explain nothing at all.

Using such expressions as these, BBC sets out a string of claims, although as one might expect, it fails to explain how any of these might have come about and which evolutionary mechanisms might have wrought such changes. These are some of the issues which BBC does not or cannot explain and which it glosses over with fancy words:

**It is He Who originated
creation and regenerates it.
That is very easy for Him.
He is the most exalted
designation in the heavens
and the earth. He is the
Almighty, the All-Wise.
(Qur'an, 30: 27)**

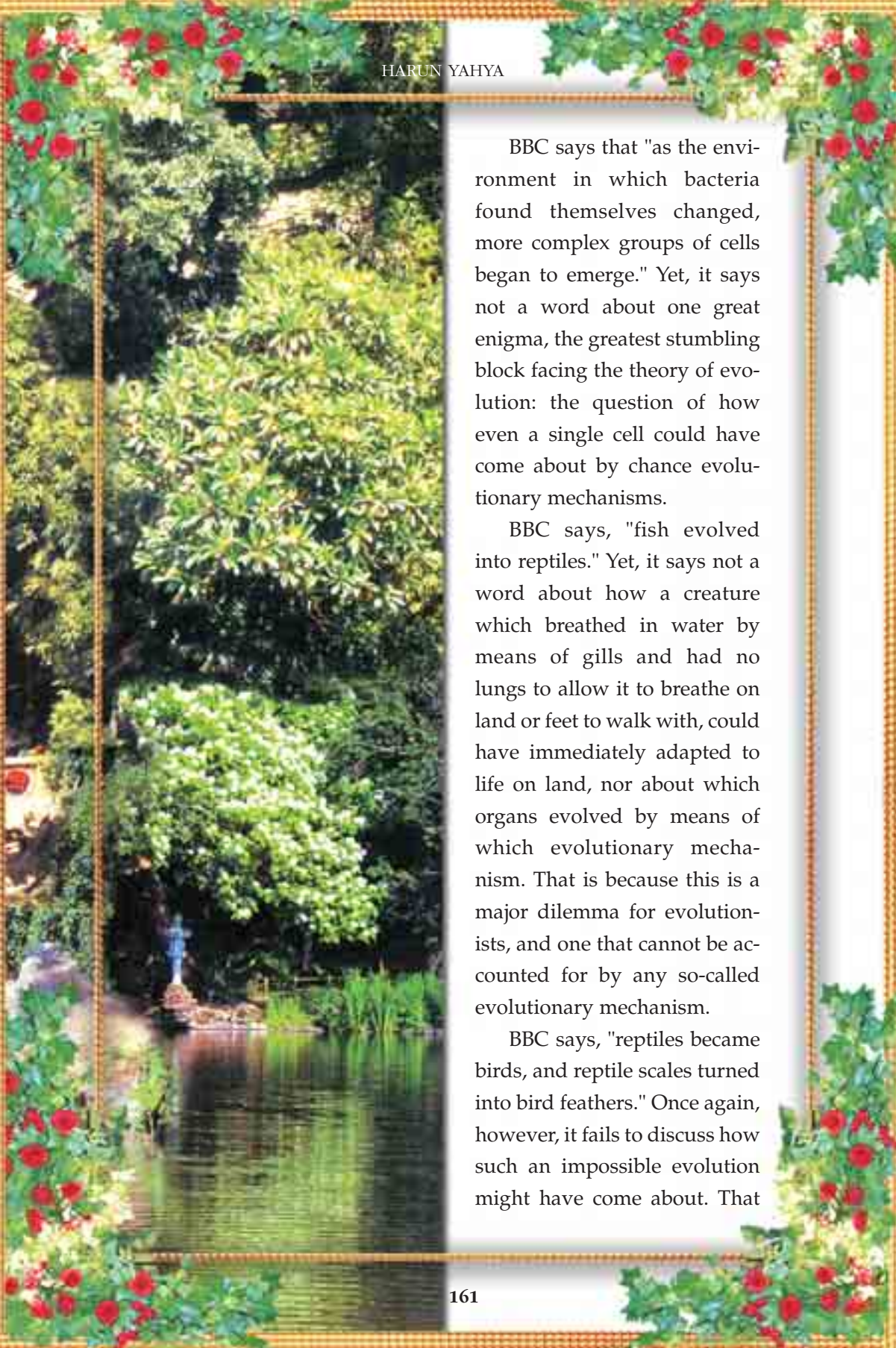

BBC says that "as the environment in which bacteria found themselves changed, more complex groups of cells began to emerge." Yet, it says not a word about one great enigma, the greatest stumbling block facing the theory of evolution: the question of how even a single cell could have come about by chance evolutionary mechanisms.

BBC says, "fish evolved into reptiles." Yet, it says not a word about how a creature which breathed in water by means of gills and had no lungs to allow it to breathe on land or feet to walk with, could have immediately adapted to life on land, nor about which organs evolved by means of which evolutionary mechanism. That is because this is a major dilemma for evolutionists, and one that cannot be accounted for by any so-called evolutionary mechanism.

BBC says, "reptiles became birds, and reptile scales turned into bird feathers." Once again, however, it fails to discuss how such an impossible evolution might have come about. That

A DEFINITIVE REPLY
TO EVOLUTIONIST
PROPAGANDA

is because evolutionists are perfectly well aware that it is impossible for reptiles to have evolved into birds by means of chance mutations, that reptile scales and bird feathers have entirely different structures, and that it is impossible for one to turn into the other.

BBC speaks of "an area shaped by evolution with unbelievable methods over thousands of years" when discussing the bones of the ear. Yet it never actually says what these methods were. That is because no such method is known to BBC or evolutionists.

BBC says, "The other parts of the ear, which provides balance and allows us to walk on two legs, as well as to hear, our hands, arms and our entire body took shape thanks to evolution." Yet it never says a word about how evolution shaped all these complex organs. That is because the theory of evolution cannot explain how organs possessed of irreducible complexity came about.

BBC says, "Decisions such as how we live, the shape of our bodies, were made billions of years before the appearance of the first human being." Yet it is unable to explain who decided what human beings' eyes, ears, hearts, and brains, which would emerge only billions of years later, would be like, nor who planned such conscious, intelligent, and organized systems in a world full of inanimate matter. Is BBC able to answer such questions? In other words, which unconscious, unaware, and unintelligent atoms in the primitive world could have planned the flawless design in the human body?



The ear is such a complex wonder of design that it alone nullifies the explanations of the theory of evolution based on "chance" occurrences. The hearing process in the ear is made possible by an irreducibly complex system.

As we have seen, BBC's evolutionist propaganda is quite baseless. It puts before its viewers claims with no element of reason, logic, or science, under a scientific mask. BBC must be aware that the theory of evolution cannot actually support such claims, since before describing the myth of evolution it stresses that the story is "hard to believe," and continues: "The miracle that makes our bodies' daily lives possible also conceals another great secret from us. That secret, one which is harder to believe, is the story of how we assumed our present appearance."

The Mistaken Idea that Life Began by itself in an Environment of Volcanoes and Sulphurous Waters

In order to see how unreasonable and illogical the theory of evolution is, it will be sufficient to have a look at this claim made in the BBC documentary: The program shows an image of Yellowstone National Park in America, where thermal springs are found, and says, "If you had been here 3 billion years ago, you would have witnessed how the first living things came into being." If witnessing the emergence of living things is such an easy matter, as evolutionists claim, why is it that they do not carry out experiments to try and create the first living things in just such an environment?

Furthermore, evolutionists could impose whatever conditions they wished in these experiments, using whatever materials they wished. In fact, the uncontrolled, chance effects in the primitive earth could be done away with, and they could use consciously directed mutations instead of random ones. They could even be allowed to use ready-made amino acids and proteins, and all the different materials necessary for life, from phosphate to carbon. Then, in addition to all of this, if they said, "We need time," they could pass the area of the experiment on to one another as a legacy for millions of years. The world's most prominent evolutionary scientists could contribute to the experiment.

**A DEFINITIVE REPLY
TO EVOLUTIONIST
PROPAGANDA**



Evolutionists claim that amino acids came about by chance in what they call the "primeval soup" and that the first life emerged in this way. If it were really that easy to witness the emergence of living things, why do evolutionists not carry out an experiment by throwing such materials into a swimming pool? Moreover, they can establish such conditions as they wish by means of modern technology. Random effects could even be eliminated in the conditions of this primitive world; consciously directed mutations could be employed instead of random ones.

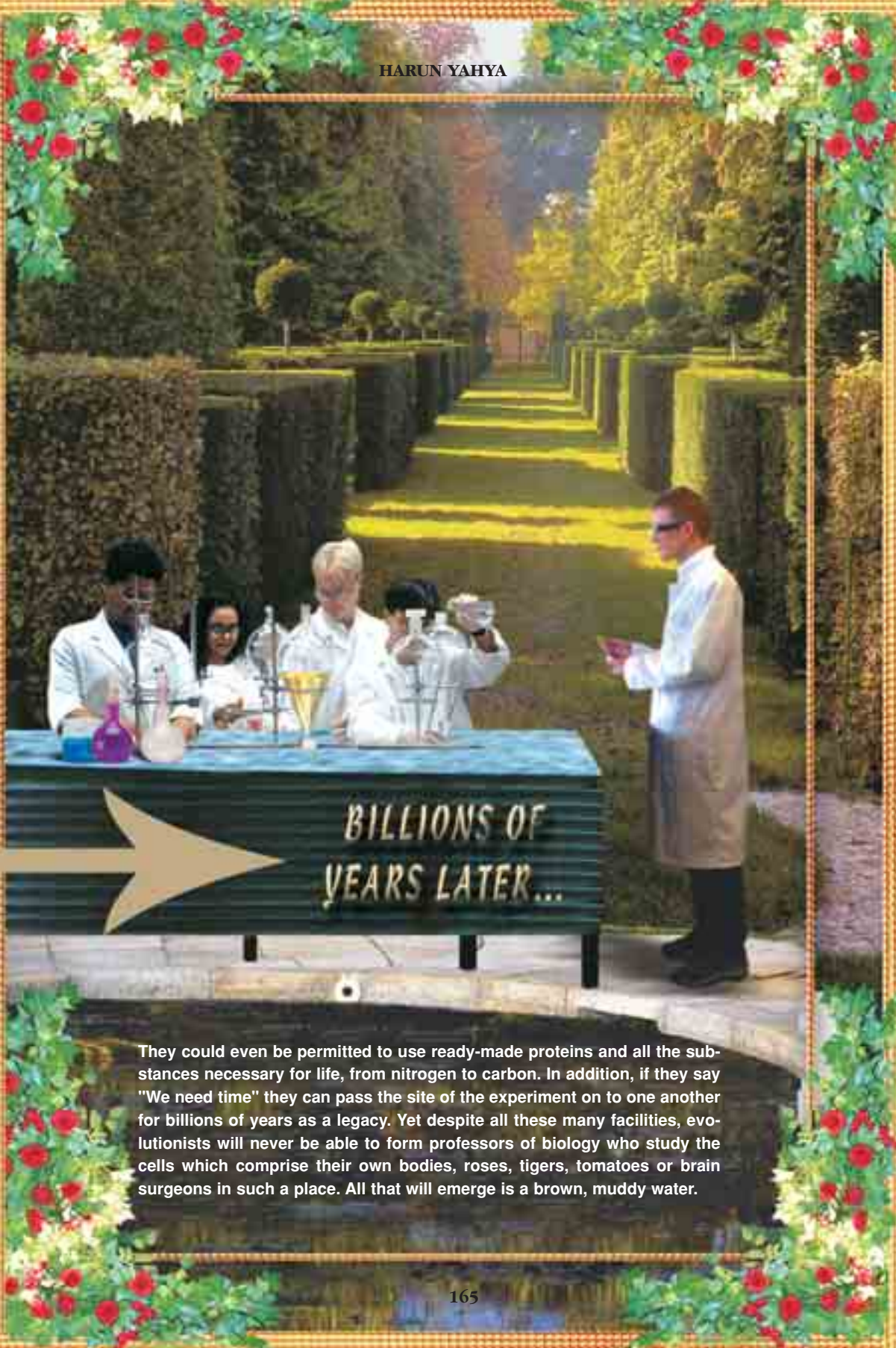

BILLIONS OF
YEARS LATER...

They could even be permitted to use ready-made proteins and all the substances necessary for life, from nitrogen to carbon. In addition, if they say "We need time" they can pass the site of the experiment on to one another for billions of years as a legacy. Yet despite all these many facilities, evolutionists will never be able to form professors of biology who study the cells which comprise their own bodies, roses, tigers, tomatoes or brain surgeons in such a place. All that will emerge is a brown, muddy water.

Yet, despite all this flexibility given to them, evolutionists would still never be able to bring about roses, leopards, eagles, pigeons, butterflies, budgerigars, cats, fig trees, mulberry trees, orange trees, tomato plants, lemon trees, melons, violets, sunflowers, film producers, writers, nuclear engineers, brain surgeons, university students, professors of biology who study the cells which make up their own bodies, university rectors, heads of state, artists, and architects. They would not even be able to produce a single cell.

Despite being an evolutionist, Professor Hoyle admitted this fact:

If there were a basic principle of matter which somehow drove organic systems toward life, its existence should easily be demonstrable in the laboratory. One could, for instance, take a swimming bath to represent the primordial soup. Fill it with any chemicals of a non-biological nature you please. Pump any gases over it, or through it, you please, and shine any kind of radiation on it that takes your fancy. Let the experiment proceed for a year and see how many of those 2,000 enzymes [proteins produced by living cells] have appeared in the bath. I will give the answer, and so save the time and trouble and expense of actually doing the experiment. You will find nothing at all, except possibly for a tarry sludge composed of amino acids and other simple organic chemicals. How can I be so confident of this statement? Well, if it were otherwise, the experiment would long since have been done and would be well-known and famous throughout the world. The cost of it would be trivial compared to the cost of landing a man on the Moon . . . In short there is not a shred of objective evidence to support the hypothesis that life began in an organic soup here on the Earth.¹⁶

Conclusion

With the documentary *The Human Body*, the BBC has entered upon a programme of evolutionary propaganda from which it can never obtain any results. Telling viewers things like "first there were bacteria, which later evolved and eventually became human beings, and this is a great miracle of evolution," without offering any scientific evidence, as if they were reading a bedtime story, is a fruitless at-

tempt to get people to believe in evolution. Today, not even middle school children take evolution seriously; indeed, they find it rather comic. Our hope is that the BBC will realize that this documentary, which it perhaps decided to air solely because of its striking images, actually contains an account which is far removed from true science, and revise it accordingly.

- 1 - Mahlon B. Hoagland, *The Roots of Life*, Houghton Mifflin Company, 1978, p.18
- 2 - Robert Shapiro, *Origins: A Sceptics Guide to the Creation of Life on Earth*, New York, Summit Books, 1986. p.127
- 3 - Fred Hoyle, Chandra Wickramasinghe, *Evolution from Space*, New York, Simon & Schuster, 1984, p. 148
- 4 - Fred Hoyle, Chandra Wickramasinghe, *Evolution from Space*, p. 130.
- 5 - Prof. Dr. Ali Demirsoy, *Kalitim ve Evrim* (Inheritance and Evolution), Ankara, Meteksan Yayınları, p.79
- 6 - Pierre-Paul Grassé, *Evolution of Living Organisms*, Academic Press, New York, 1977, p. 87
- 7- B. G. Ranganathan, *Origins?*, Pennsylvania: The Banner Of Truth Trust, 1988
- 8 - Charles Darwin, *The Origin of Species*, pp. 172, 280
- 9 - Derek A. Ager, "The Nature of the Fossil Record," *Proceedings of the British Geological Association*, Vol. 87, 1976, p. 133
- 10 - Mark Czarnecki, "The Revival of the Creationist Crusade," *MacLean's*, 19 January 1981, p. 56
- 11 - *Science*, July 17, 1981, p. 289
- 12 - G. G. Simpson, W. Beck, *An Introduction to Biology*, New York, Harcourt Brace and World, 1965, p. 241
- 13 - Keith S. Thompson, "Ontogeny and Phylogeny Recapitulated," *American Scientist*, volume 76, May / June 1988, p. 273
- 14 - Ken McNamara, "Embryos and Evolution," *New Scientist*, 16 October 1999
- 15 - Francis Hitching, *The Neck of the Giraffe: Where Darwin Went Wrong*, New York: Ticknor and Fields 1982, p. 204
- 16 - Sir Fred Hoyle, *The Intelligent Universe*, New York: Holt, Rinehart and Winston, 1983, pp. 20-21



**EVOLUTIONARY TALL TALES
FROM THE BBC -II-**



The second installment of the documentary, *The Human Body*, again consisted of evolutionist propaganda devoid of any scientific credibility. The errors in the documentary prepared by BBC are scientifically explained below.

BBC's Tall Tale about "Fish Gills Becoming Human Cars"

The BBC documentary maintained that human beings and fish had a common ancestor, and that traces can still be found in the human body which prove this. According to BBC, the human ear is one example of such a trace, and its origin is to be found in the bones beside the gills in the fish, with which we share (!) a common ancestor.

This BBC claim rests on the theory of "recapitulation," which has long since been discredited in the scientific literature. Since this matter has already been dealt with in the article "Evolutionary Tall Tales from BBC - I," there is no need to repeat it here.

The subject to be considered here is that the human ear possesses such a complex structure that it could never have evolved from a fish bone.

The Human Ear Possesses Irreducible Complexity

The significance of the irreducible complexity possessed by the human ear is this: The human ear is made up of several separate parts all coming together, and we are able to hear as a result of all these parts' working in harmony together. If one of these components is deficient, then we either become deaf or else our sense of hearing suffers serious damage. It is impossible for an organ possessing irreducible complexity to develop by stages, by chance, in a process of evolution. A brief résumé of how hearing actually takes place will enable this fact to be more clearly understood.

**A DEFINITIVE REPLY
TO EVOLUTIONIST
PROPAGANDA**

As is commonly known, the hearing process begins with vibrations in the air. These vibrations are enhanced in the external ear by about 17 decibels.¹

Sound intensified in this way enters the external auditory canal. This is the passageway leading from the external ear to the eardrum. One interesting feature of the auditory canal, which is some three and a half centimeters long, is the wax it constantly secretes. This liquid contains an antiseptic property which keeps bacteria and insects out. Furthermore, the cells on the surface of the auditory canal are aligned in a spiral form directed towards the outside, so that the wax always flows towards the outside of the ear as it is secreted.

Sound vibrations that pass down the auditory canal in this way reach the eardrum. This membrane is so sensitive that it can even perceive vibrations on the molecular level. Thanks to the exquisite sensitivity of the eardrum, you can easily hear somebody whispering from yards away. Another extraordinary feature of the eardrum is that after receiving a vibration it returns to its normal state. Calculations have revealed that, after perceiving the tiniest vibrations, the eardrum becomes motionless again within up to four thousandths of a second. If it did not become motionless again so quickly, every sound we hear would echo in our ears.

The eardrum amplifies the vibrations that come to it, and sends them on to the middle ear region. Here, there are three bones in an extremely sensitive equilibrium with each other. These three bones are known as the hammer, the anvil, and the stirrup; their function is to amplify the vibrations that reach them from the eardrum.

But the middle ear also possesses a kind of "buffer," to reduce exceedingly high levels of sound. This feature is provided by two of the body's smallest muscles, which control the hammer, anvil, and stirrup bones. These muscles enable exceptionally loud noises to be reduced before they reach the inner ear. Thanks to this mechanism, we hear sounds that are loud enough to shock the system at a reduced volume. These muscles are involuntary, and come into operation automatically.

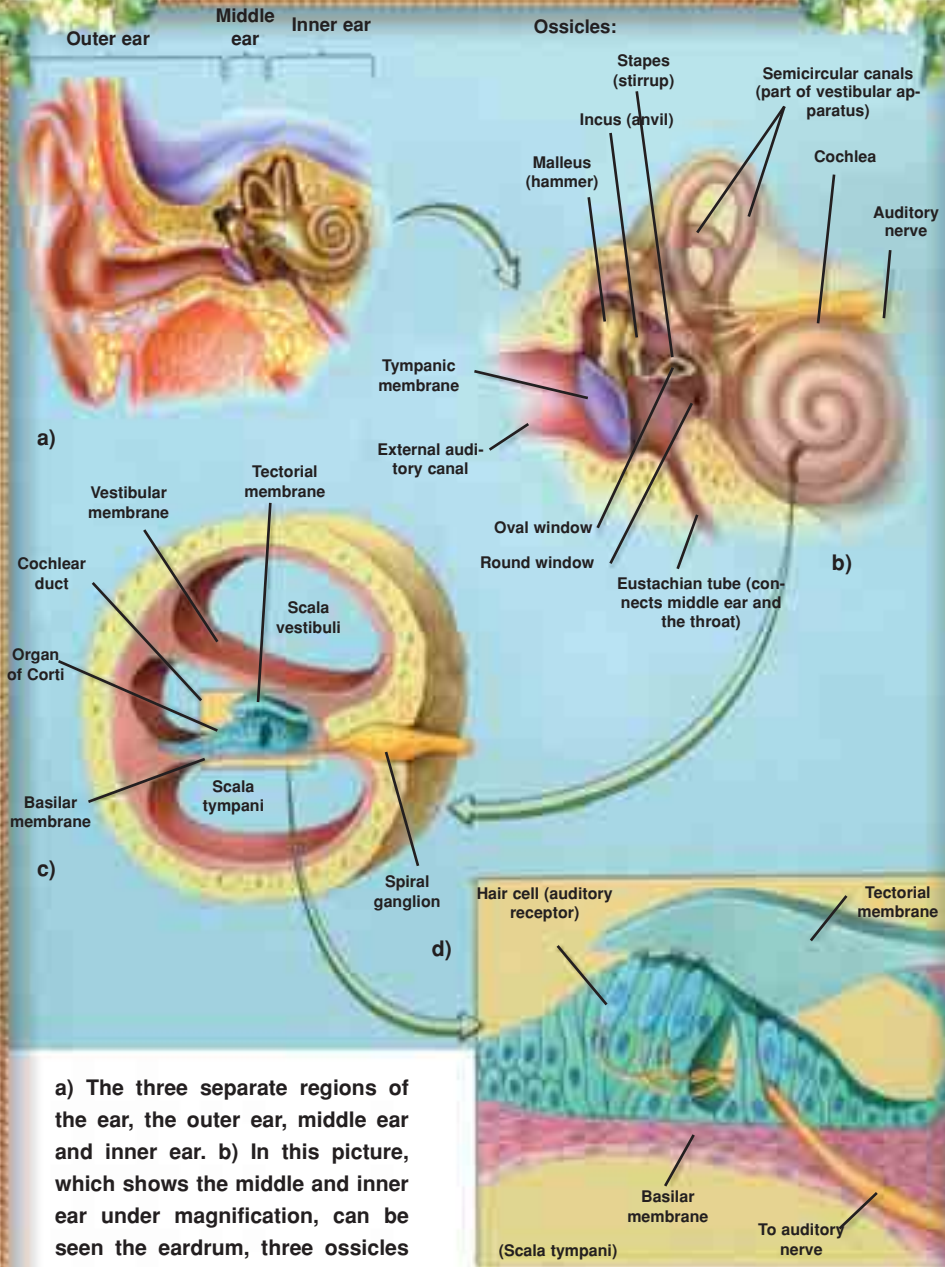

a) The three separate regions of the ear, the outer ear, middle ear and inner ear. b) In this picture, which shows the middle and inner ear under magnification, can be seen the eardrum, three ossicles and the oval window connecting them. Sound waves striking the eardrum cause these ossicles to vibrate, thus causing the fluid in the next structure along, the cochlea, to move. c) There are three areas in this cross section of the cochlea. In the middle are the organ of Corti and sound receptors. d) This magnified diagram shows the tiny hairs in the organ of Corti. It is thanks to these hairs that sound signals reach the brain.

**A DEFINITIVE REPLY
TO EVOLUTIONIST
PROPAGANDA**

The middle ear, which possesses such a flawless design, needs to maintain an important equilibrium. The air pressure inside the middle ear has to be the same as that beyond the eardrum—in other words, the same as the surrounding atmospheric air pressure. But this balance has been thought of, and a canal between the middle ear and the outside world allowing an exchange of air has been built in. This canal is the Eustachian tube, a hollow tube running from the inner ear to the oral cavity.

The process whereby these mechanical motions begin to be turned into sound begins in the area known as the inner ear. In the inner ear is the cochlea, a spiral-shaped organ filled with liquid. The cochlea is linked to the stirrup bone by a membrane. By this connection, the mechanical vibrations in the middle ear are sent on to the liquid in the cochlea.

The vibrations which reach the liquid in the cochlea set up wave effects in it. The inner walls of the cochlea are lined with small hair-

The vibrations from an external noise cause the liquid in the inner ear to vibrate. The movement of this liquid sets the tiny hairs on the inner walls of the cochlea, shown in this picture, in motion. The movements of these hairs allow the sound of a violin, a television newsreader's voice or the wailing of a cat in the street to reach the brain in the form of electrical signals. Thanks to these flawless structures we are able to distinguish between millions of different sounds. Science has still not unravelled all the technical details of this system, which has been functioning flawlessly ever since the first human being. Here, we need to see the immaculate art of God, our Creator, and give thanks for the blessings He has bestowed upon us.

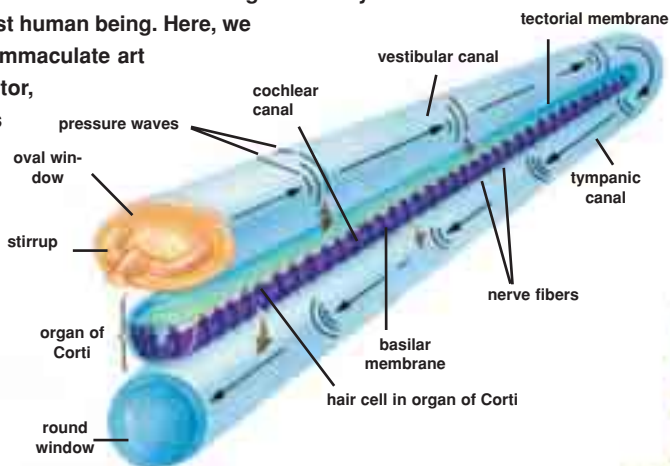

like structures, called stereocilia, which are affected by this wave effect. These tiny hairs move strictly in accordance with the motion of the liquid. If a loud noise is emitted, then more hairs bend in a more powerful way. Every different frequency in the outside world sets up different effects in the hairs.

But what is the meaning of this movement of the hairs? What can the movement of the tiny hairs in the cochlea in the inner ear have to do with listening to a concert of classical music, recognizing a friend's voice, hearing the sound of a car, or distinguishing the millions of other kinds of sounds?

The answer is most interesting, and once more reveals the complexity of the design in the ear. Each of the tiny hairs covering the inner walls of the cochlea is actually a mechanism which lies on top of 16,000 cells. When these hairs sense a vibration, they move and push each other, just like dominos. This motion opens channels in the membranes of the cells lying beneath the hairs. And this allows the inflow of ions into the cells. When the hairs move in the opposite direction, these channels close again. Thus, this constant motion of the hairs causes constant changes in the chemical balance within the underlying cells, which in turn enables them to produce electrical signals. These electrical signals are forwarded to the brain by nerves, and the brain then processes them, turning them into sound.

Science has not been able to explain all the technical details of this system. While producing these electrical signals, the cells in the inner ear also manage to transmit the frequencies, strengths, and rhythms coming from the outside. This is such a complicated process that science has so far been unable to determine whether the frequency-distinguishing system takes place in the inner ear or in the brain.

Everything we have examined so far has shown us that the ear possesses an extraordinary design. On closer examination, it becomes evident that this design is irreducibly complex, since, in order for hearing to happen, it is necessary for all the component parts of the auditory system to be present and in complete working order.

Take away any one of these parts—for instance, the hammer

A DEFINITIVE REPLY
TO EVOLUTIONIST
PROPAGANDA

bone in the middle ear—or damage its structure, and you will no longer be able to hear anything. In order for you to hear, such different elements as the eardrum, the hammer, anvil, and stirrup bones, the inner ear membrane, the cochlea, the liquid inside the cochlea, the tiny hairs that transmit the vibrations from the liquid to the underlying sensory cells, the sensory cells themselves, the nerve network running from them to the brain, and the hearing center in the brain—all of these parts must exist in complete working order. The system cannot develop "by stages," because the intermediate stages would serve no purpose.

The claim that an organ as complex as the ear should have been constructed in stages by an unconscious process dependent solely on random chance, such as evolution, is both unscientific and irrational. BBC must be aware of this impossibility, since it frequently repeats that this is a miracle that is very difficult to believe, and says:

Not even sound systems with the very highest technology can offer us the sound quality we enjoy when listening to a piece of music. The flesh and blood audio system in our ears is flawless. Scientists have still not fully understood this extraordinary system. Believing that such perfection could have come about by chance takes one no further than believing in fairy stories.



"Evolution shapes our bodies. It is hard to believe that it could bring all this about."

BBC's Time Error

One of the claims frequently repeated on BBC's documentary is that minute changes combined over time to bring about major transformations, and that this is how evolution, which looks to be impossible at first sight, actually happens.

At the root of this argument, which is one of BBC's and other evolutionists' fundamental refuges, lies the assumption that time is a force that can do the impossible. According to this view, it is impossible for a chemical mixture to randomly produce amino acids, proteins, DNA, RNA, and other cell components, and thus a living cell—or, alternatively, for a reptile to turn into a bird—in a short space of time. As time goes on, however, for instance over millions of years, the impossible suddenly becomes possible.

Evolutionists describe this time factor as "the accumulation of advantageous coincidences." In other words, a structure will gain a positive feature by means of an advantageous coincidence, another such coincidence will be added to it a few thousand years later, yet another one will happen a few thousand years after that, and at the end, over the course of millions of years, these advantageous coincidences will combine to bring about a major and positive transformation.

Many people may accept this logic without examining it too closely. Yet, it contains a simple but fundamental error. This lies in the concept of "advantageous coincidences being added on to one another." The fact is that there is no mechanism in nature that might be expected to select advantageous coincidences and hold on to them in order to add them to one another.

We can clarify what this means with an example that evolutionists also resort to. Some scientists say that the possibility of a protein being synthesized by chance is "less than the probability of a monkey typing out the history of mankind without any mistakes."²

**A DEFINITIVE REPLY
TO EVOLUTIONIST
PROPAGANDA**

Yet evolutionists still hide behind the idea of time in the face of such inconsistencies. This is the kind of claim they make: "Every time the monkey touches the keyboard it has a one-in-26 chance of hitting the right key. Once it has pressed the right key, this is chosen as the right letter by natural selection. The errors it will commit over the next letter are again chosen by natural selection. In this way, over a period lasting millions of years, a monkey can indeed write a history of mankind."

This is the logic that underlies all the time-related claims made by evolutionists.

The fact is, however, that, as we have already stated, there is a simple error in this position: There is no mechanism in nature to identify and select which of the keys pressed by the monkey is the right one! There is no consciousness which can say, "OK. This letter is right, let's hold on to it and move on to the next stage."

Moreover, neither is there any monkey to touch the keys in nature. That requires consciousness. The evolutionists' argument must be that natural effects such as wind, rain, and earthquakes cause the typewriter keys to move.

When we examine the scenario that the cell and all living structures have come about by chance in this more realistic light, we see that we are actually dealing with nonsense. The idea that a single cell emerged by chance—that is, that the millions of tiny coincidences that form the building blocks of the cell occurred at random in an ordered sequence—can be compared to the claim that a giant city emerging solely by natural means, with no constructive force behind it. Rain, earth, and heat would have to combine by chance to form millions of bricks. Then these bricks would have to line up side by side and one on top of the other, under the effects of such things as wind, flood, and earthquake, to make houses, roads, and pavements, as a result of which a whole giant city would eventually emerge by chance.

If someone suggested such a thing to you, you would seriously doubt that person's sanity. Would anything change if that person



According to Ali Demirsoy, a Turkish biologist, the probability of a coincidental formation of cytochrome-C, an essential protein for life, is "as unlikely as the possibility of a monkey writing the history of humanity on a type-

writer without making any mistakes." There is no doubt that to accept such a possibility is actually to reject the basic principles of reason and common sense.

then suggested that this happened not in a short space of time but over millions of years?

Of course not. Nonsense is nonsense, and the impossible is impossible, no matter how long a time it is allowed for it. That is why the BBC's invocation of "time" as a savior does not actually validate its claims.

Conclusion

There are unscientific claims and evolutionist propaganda in the BBC documentary. We hope that those who broadcast this documentary will have another look at its contents, will see that no scientific evidence for the evolutionary scenarios recounted in it like fairy tales has been put forward, and will cease showing it.

1 - *Color Atlas of Human Anatomy*, Harmony Books, New York, 1994, p. 70

2- Ali Demirsoy, *Kalıtım ve Evrim* (Inheritance and Evolution), Ankara: Meteksan Publishing Co., 1984, p. 64



**EVOLUTIONARY TALL TALES
FROM THE BBC -III-**

The blind evolutionist dogma also appears in the third episode of the documentary *The Human Body*, prepared by the BBC. This episode deals with the birth process, and, after describing the extraordinary events undergone by a baby in its mother's body before birth, suggests that there is "no design" in any of them. As will clearly be seen after an examination of the proper accounts set out below, this claim is even more nonsensical than suggesting that a 100-storey building equipped with the most advanced technology could have formed itself in the middle of a city, with no designer or conscious builders involved.

The Design Denied by the BBC is an Obvious Fact

After a description of the events experienced by a baby growing in its mother's body and the way that all the conditions for birth are met with no intervention by the mother herself, the following words are spoken: "Our bodies did not emerge as the result of design. Our bodies assumed their present forms as the result of enormous transformations. Those features which keep our bodies from perfection are problems inherited from our ancestors. The real miracle lies in the finding of a solution to these problems."

These words are nothing more than totally baseless Darwinist propaganda. In saying that there is no design in the body, BBC is denying the truth of the existence of God and claiming that it was blind chance and unconscious atoms that gave rise to the human body. BBC, the producer of the documentary, accepts that there are certain difficulties during birth, but says that, although these problems are "miraculously" resolved, they are a legacy from man's ape ancestors, and that it is again blind chance and unconscious atoms which bring these solutions about. In order to see how unrealistic this claim by BBC is, we need look no further than a few of the ex-

**A DEFINITIVE REPLY
TO EVOLUTIONIST
PROPAGANDA**

amples concerning birth given in the documentary:

The eye sockets form first in the embryo's skull in the mother's womb. The eyes are later sited within these sockets. If we think along lines similar to BBC's claim and assume that there is "no design" here, then we should believe the following: The atoms and the cells composed of these atoms which make up the embryo are so intelligent, conscious, far-seeing, and capable of working as a team (!) that they are fully aware of what the eye is, how it works, and what seeing means. They are capable of working in such a planned manner as to prepare a home for the eyes before these are even formed. Alternatively, there has been such an unbelievable coincidence that first of all the two sockets in the embryo's skull happen to form by chance. Then, again by chance (!), these sockets are placed symmetrically and regularly in the human face, in the most aesthetically pleasing location.

The pelvis is the widest part of the human body. The width of the pelvic bone is ideal for man to be able to walk and stand on two legs and for the baby to squeeze its head through during birth. If we again think along similar lines to the NTV claim and assume for one moment there is "no design" here, we should have to believe this: The unconscious atoms which decided to construct the human body came together and decided on the ideal dimensions for man to be able to walk and stand on two legs and to give birth. They then built



the human skeleton with these dimensions in mind. Alternatively, and again by chance, the cells came together in such dimensions and in such an organized manner that they happened to form the most ideal bone and skeletal structure for man to be able to walk and give birth (!).

There is no difference between believing that scenario and believing that idols made out of stone or wood possess a creative power. The one is as nonsensical as the other. The truth is that none of the events which go on in the mother's body during birth can be explained by chance. God's superior art of creation and infinite knowledge can be seen at every stage of the process. A few examples of what happens during birth will be provided below, although these are only some out of many thousands. As we shall see, saying that these are the result of chance is a violation of reason and logic:

The embryo needs to be situated in an appropriate place if the pregnancy is to continue in a healthy manner. The place selected must offer both protection and the capability for birth to take place nine months later. This place must also be near the blood vessels in the mother's body, which will allow nutrition to reach the baby. The ideal spot is of course the uterine lining.

When conception occurs in one of the Fallopian tubes, the zygote continues to move down the tube towards the womb, as though it were aware of its destination. Ordinarily, it does not stop

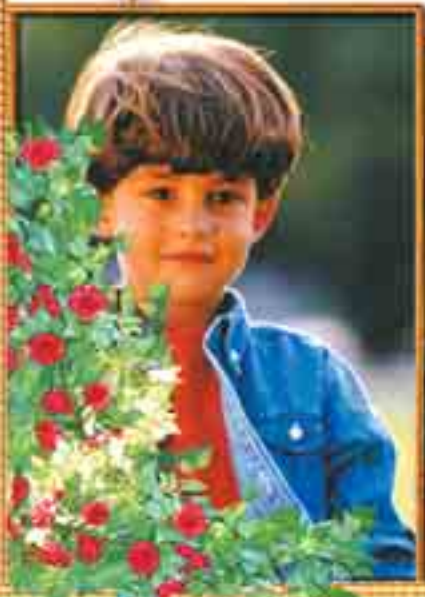

A DEFINITIVE REPLY
TO EVOLUTIONIST
PROPAGANDA



or attach itself to any part of the Fallopian tube, in which it can remain for 3-4 days. It behaves as if it were aware that, by trying to attach itself anywhere before reaching the womb, it would forfeit its chances of survival. The zygote moves forward as far as the womb, finds an area on the womb lining rich in blood vessels, and attaches itself there. Like a seed thrown into the earth sprouting and putting down roots, the implanted embryo now continues to grow and also creates new channels of nutrition for itself by moving deeper into the tissue that will provide nutrition for it.

It will be useful to draw attention to one particular point here. The very fact of the zygote's being able to select the most suitable place for itself is a miracle. G. L. Flanagan, author of the book *Beginning of Life*, stresses the extraordinary nature of this:

*How does the [cell] cluster make such an astonishingly "forward-looking" selection?*¹

There is no doubt that this far-sightedness belongs not to a collection of cells devoid of any

capacity for thought, but to the Creator who brought it into being. BBC tries to ignore this fact, and is committing a grave error in doing so.

As birth approaches, the amniotic fluid embarks on those activities that will be necessary to facilitate that birth. It forms fluid sacs, which will enlarge the mouth of the womb, thus allowing the womb to assume the dimensions to allow the baby to pass. These sacs also prevent the fetus from being crushed in the womb during birth. Furthermore, when the sacs burst and release their fluid at the commencement of birth, the path to be taken by the fetus is both lubricated and sterilised. In this way, birth takes place more easily and in a manner naturally free of germs.²

As well as all these preparations in the womb, a great many other conditions also need to be met at the same time in order for the baby to come into the world safely. For instance, the baby needs to assume the best position for entry into the world. It slowly begins to turn with a succession of foot movements and thus enters the neck of the womb. The baby's scope for movement is now restricted and it cannot move



**A DEFINITIVE REPLY
TO EVOLUTIONIST
PROPAGANDA**

its head.³ But how does an as-yet-unborn baby decide which position is best? How does it know what the most suitable position is? Moreover, how does a baby in its mother's womb know when the time to be born has come? All these questions show that the beginning of human life comes about with a flawless design and not, as the BBC documentary would have it, through evolution based on chance.

Many more examples of this miraculous design can be seen as the baby comes into the world. For instance, the baby's skull needs to have a structure which will not damage the birth canal, if a healthy birth is to take place. When we look at the baby's skull, we see a group of five bones with a soft spot called the "fontanelle" between them. This soft structure gives the skull a flexibility that prevents damage to the baby's brain and skull from the pressure that occurs during birth..

Many volumes have been written about the events of birth, which clearly reveal that they are flawlessly planned. They show



This picture shows the emergence of a baby through the mother's pelvis. The harmony in this design clearly shows the infinite wisdom and might in the creation of man.



that chance plays no role whatsoever in the creation of a human being. Which of these events could be claimed, with scientific evidence, to have come about by chance? The miracles repeated throughout the length of the BBC documentary are miracles of God, not of unconscious atoms and blind chance.

In the Qur'an, God reveals this to those who deny Him despite the clear nature of His creation:

... Do you then disbelieve in Him Who created you from dust, then from a drop of sperm, and then formed you as a man? He is, however, God, my Lord, and I will not associate anyone with my Lord. (Qur'an, 18: 37-38)

Conclusion

It is utterly obvious that it is God Who created living things and the entire universe. It is also clear that living things possessed of such a flawless order and exceedingly complex structures cannot be the work of chance. Despite this, however, those who maintain that the universe and living things were created by chance are defending nonsensical claims that even children would find laughable. They fail to think honestly, and insist on denying the existence of God.

We do not believe that the BBC genuinely supports such irrational claims. This documentary provides striking images and effective information, and describes instances of God's creation in a beautiful way, we imagine that the meaningless, unproven, irrational, and illogical evolutionist claims scattered throughout it have escaped their notice. We hope that the BBC will rid itself of this evolutionist propaganda, which is meaningless and devoid of scientific evidence and credibility.

1. Geraldine Lux Flanagan, *Beginning of Life*, Dorling Kindersley, London, 1996, p.33.
2. Laurence Pernoud, *J'attends un enfant*, Pierre Horay, p.138.
3. Geraldine Lux Flanagan, *Beginning Life*, p.103.



**THE BBC'S FUNCTIONLESS
TISSUE ERROR IN
ITS DOCUMENTARY
*THE HUMAN BODY***

Another outdated evolutionist claim appeared in the documentary *The Human Body* by the BBC which introduces the systems in the human body. As it described the changes brought about in young people by puberty and hormones, oil glands in the skin were described as the source of pimples. Yet, it was also suggested that oil glands are functionless pieces of tissue serving no purpose, and that they are a legacy from man's so-called ape-like ancestors. This claim, devoid of any scientific foundation, is dealt with below.

The Functionless Tissue Claim Is Not Scientific

This claim aired on BBC is nothing more than a new example of the idea of "vestigial organs" put forward by evolutionists a hundred years ago. According to this hoary old claim, there are various organs in the bodies of living things which are a legacy from their ancestors, but which have gradually grown redundant from lack of use. However, it eventually emerged that this claim was based on a lack of scientific knowledge, and that "vestigial organs" were actually "organs whose functions had not been identified yet." One of the best indications of this was the way the list of these "vestigial organs" increasingly shrank. The list of "vestigial human organs" drawn up by the German anatomist R. Wiedersheim in 1895 included some 100 organs, including the appendix and the coccyx. As science advanced, however, it was realized that all the organs on the list did actually serve important functions. (see <http://www.harun-yahya.com/refuted11.php>)

In short, the scenario of redundant organs put forward by evolutionists was scientifically wrong. There is no organ in the bodies of human beings or other living things which is redundant or functionless, and a legacy from so-called ancestors.

A vibrant garden scene with a man and a child sitting on a path, surrounded by various flowers and trees. The man is wearing a plaid shirt and the child is wearing a green shirt. They are both looking down at something in their hands. The garden is filled with green foliage, red roses, and a path leading into the distance. The text is overlaid on the top half of the image.

He Who created the seven
heavens in layers. You will not
find any flaw in the creation of
the All-Merciful. Look again—do
you see any gaps? Then look
again and again. Your sight will
return to you dazzled and
exhausted! (Qur'an, 67:3-4)

The Essential Function of Oil Glands

Contrary to what evolutionists imagine, oil glands are not functionless and redundant; on the contrary, they are essential tissues for the body.

As we know, sweat glands are found together with oil glands in the skin. Sweat allows the skin to be moisturised. On its own, however, sweat immediately evaporates, leading to greater drying of the skin. In order to prevent this, another secretion is needed. That is because an oily environment allows water to be retained in the skin. In this way, the sweat and oil glands work together to moisturise the skin. That is why it is essential for both glands to be present at the same time in order for the skin to be soft and elastic. The function of the oil glands, which secrete wax and other lipids, is necessary for the health of our skin.

As we have seen, oil glands, like other tissues, serve a particular purpose: preventing our skin from drying out. The oil glands have been located where our sweat glands are for just this purpose. The fact that these glands are not harmful, and that on the contrary they serve an essential function, is proof of an intelligent design, in other words a superior creation. That creation is the art of God, Exalted in Power, the Lord of the heavens and the earth and all that lies between.



**BBC'S EVOLUTION OF THE
HUMAN BRAIN ERROR**

This part of the documentary, *The Human Body*, prepared by BBC dealt with the human brain. In this episode, the information provided about the brain was supplemented with the usual evolutionist propaganda clichés, and the complexity in the human brain was described as a "miracle of evolution."

Saying that Chance Created Millions of Miracles is Absurd in the Highest Degree

A great deal of information has so far been provided about birth and the human body in the BBC documentary, *The Human Body*. One of the most frequently repeated phrases in the program is "this is a miracle of evolution." BBC speaks of evolution as something conscious, which knows what it is doing, makes plans, and flawlessly organizes inanimate objects and atoms, and the channel is perhaps not aware of the real significance underlying this logic.

"The miracle of evolution" means "the miracle of chance," since according to the theory of evolution inanimate substances organized themselves as the result of coincidences to produce all living things. According to this claim, atoms such as carbon, phosphate, hydrogen, oxygen, and nitrogen gave rise to proteins, cells, bacteria, fish, birds, starfish, dolphins, leopards, elephants, bees, ants, eagles, lions, roses, oranges, the human brain, the human heart, the human hand (which still cannot be replicated with all our present-day technology), the eyes, and man himself, who thinks, takes decisions, reads, understands what he reads, and feels joy, sorrow, and excitement—and all this by chance. Every one of these complex and flawless structures and features is a miracle, and there are an infinite number of miracles in the universe. There is no doubt that to claim that all these came about by chance is "absurd in the highest degree." Charles Darwin, the architect of the theory of evolution, realized this and made the following confession about the eye, just one

of these countless complex structures:

To suppose that the eye with all its inimitable contrivances for adjusting the focus to different distances, for admitting different amounts of light, and for the correction of spherical and chromatic aberration, could have been formed by natural selection, seems, I freely confess, absurd in the highest degree.¹

In order to better understand how stupid it is to maintain that all living things and all the structures and organs in them came about by chance, it will be sufficient to recall just a few of the features of the brain, the subject of the BBC documentary.

An adult's brain contains some 10 billion neurons (nerve cells). Neurons have projections called "axons" and "dendrites," and by means of these, the neurons are interconnected. Thanks to these connections, known as synapses, one neuron is able to send messages to another. In his book *Evolution: A Theory in Crisis*, the famous biochemist Michael Denton states that the number of connections between neurons is in the region of 1 quadrillion (10^{15} or 1,000,000,000,000,000). He then goes on to say:

It is hard to imagine the multitude that 10^{15} represents. Take half of the United States, which is 1 million square miles, and imagine it being covered by forest, with 10,000 trees per square mile. On each of the 10,000 trees, which are on each of the one million square miles, there are 100,000 leaves. That's

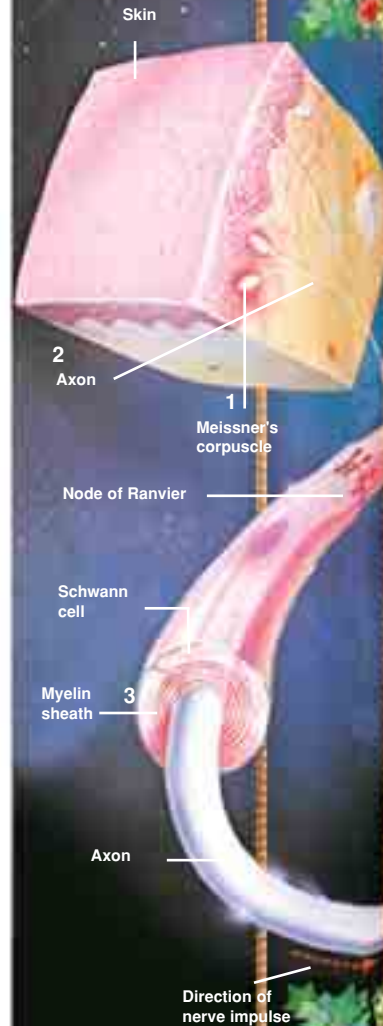

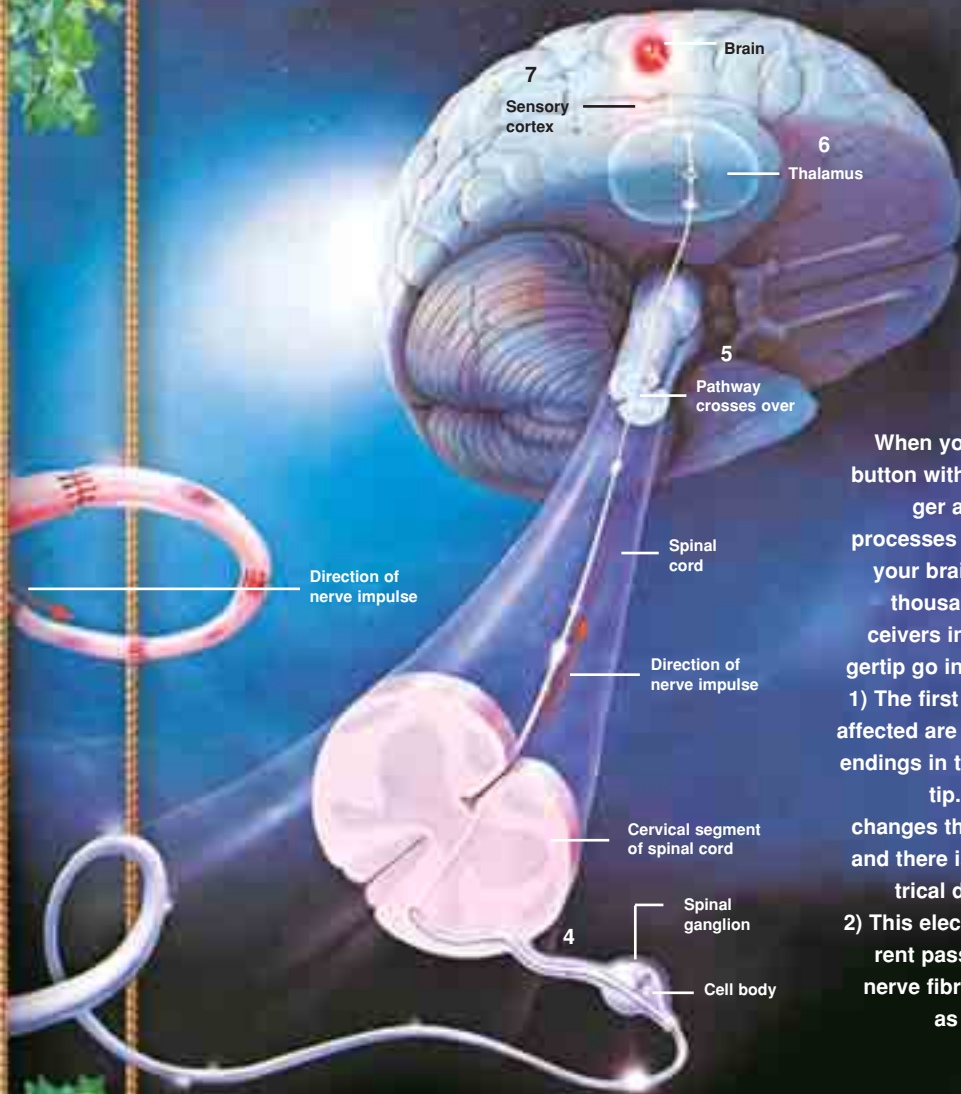

When you press a button with your finger a series of processes occurs in your brain. Firstly, thousands of receivers in your fingertip go into action. 1) The first receivers affected are the nerve endings in the fingertip. Pressure changes their shape and there is an electrical discharge. 2) This electrical current passes to the nerve fibres known as the axon.

3) It moves through the spinal cord at 133 metres per second. 4) After the signal enters the spinal column 5) it moves in the opposite direction to the medulla oblongata in the brain. 6) From here it moves to the thalamus and reaches the sensory cortex, its final destination. All these processes happen in less time than it takes you to blink your eye.



how many connections are crammed inside your brain.²

Every one of these countless and interlinked connections in the brain, an organ so small it fits into the human skull, has been created in exactly the form required and for a specific purpose. Thanks to these connections, the result of the superior design in God's creation, we are able to perform various functions at the same time with no confusion arising. For example, you can listen to music at the same time as reading these words, while also sipping a cup of coffee. At the same time, moreover, your brain regulates your heartbeat, allows you to breathe by carefully keeping the oxygen levels in your blood at a fixed rate, regulates your body temperature, calculates which of your muscles in your hand need to contract, and by how much, in order for you to lift your cup to your lips without spilling it, and also performs detailed calculations necessary for your sense of balance to allow you to remain on your feet, and it does all this without your being aware of it. Hundreds of different functions like these are carried out by the brain in the most perfect manner throughout our lives. Yet, we are quite unaware of all these calculations going on in it.

An article called "Computing from the Brain," in *New Scientist* magazine, drew the following analogy regarding the brain's extraordinary performance capability:

In crude terms, the human brain is a natural computer composed of 10 to 100 billion neurons, each of which connects to about 10,000 others, and all of which function in parallel. ...Neuronal systems take about 100 processing steps to perform a complex task of vision or speech which would take an electronic computer billions of processing steps.³

As we have seen, the human brain possesses far superior features to computers produced by the most highly advanced technology. Yet, for some reason evolutionists, who accept that computers could never come about by the chance combination of such substances as silicon, wire, and glass, refuse to accept that the human

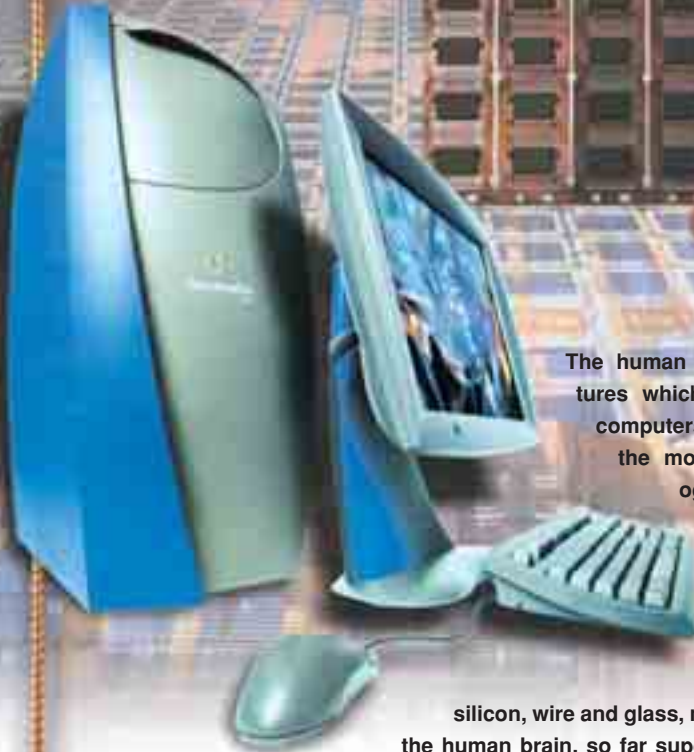

The human brain possesses features which are far superior to computers equipped with even the most advanced technology. Evolutionists, however, who accept that a computer could never come about by the random coming together of substances such as silicon, wire and glass, nevertheless claim that the human brain, so far superior to any computer, could form by the chance coming together of carbon and nitrogen atoms etc. This is very definitely a major contradiction.

brain, so far superior to any computer, could not have come about by chance combinations of atoms such as nitrogen, carbon, and oxygen. Indeed, they harbor not the slightest doubts, or at least choose to give that impression. The fact is, however, that if designers, engineers, a technical team, materials in the right quantity and of the right quality, and expert knowledge are necessary for the construction of a computer, then the same thing applies to the brain. Yet, none of these things is to be found in nature. In order for the mate-

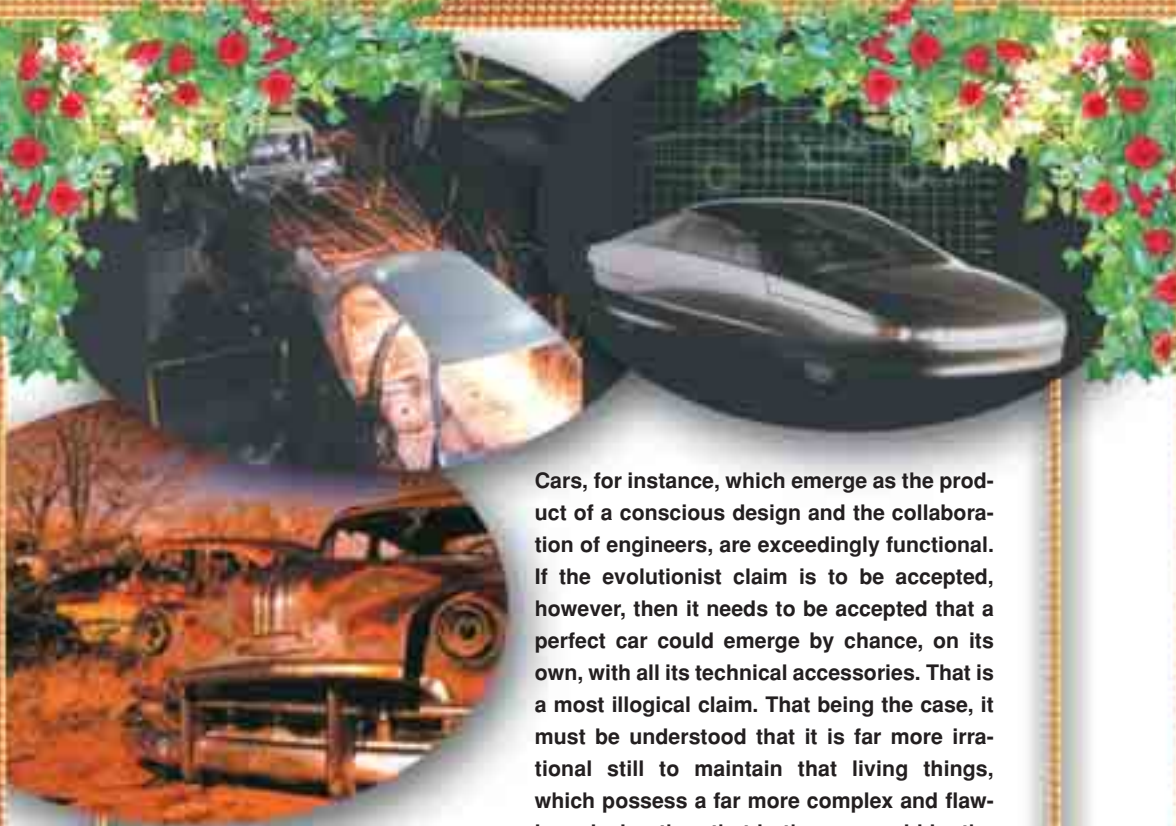

Cars, for instance, which emerge as the product of a conscious design and the collaboration of engineers, are exceedingly functional. If the evolutionist claim is to be accepted, however, then it needs to be accepted that a perfect car could emerge by chance, on its own, with all its technical accessories. That is a most illogical claim. That being the case, it must be understood that it is far more irrational still to maintain that living things, which possess a far more complex and flawless design than that in the car, could be the product of chance.

rials in nature to give rise to birds, fish, horses, flowers, and human beings of all races, it is clear that they need the existence of a superior Creator, possessed of infinite knowledge, wisdom, and power, as well as a flawless design capability. That creator is God, the Lord of all, Who created all the worlds from nothing.

There is no Mechanism in Nature Which Could Turn the Ape Brain into a Human One

A classical evolutionist claim was repeated on the BBC documentary, in which it was suggested that the brains of our ape-like ancestors turned into the human brain over a period of some 2.5 million years. An analogy was drawn: The brain capacity of our ape-like ancestors was compared to a small Fiat car engine, and that

of modern man to a much more developed sports car engine.

In fact, this comparison undermines the evolutionists' own thesis. Everyone knows that no car engine could turn into another, more highly developed one as the result of chance. Not even in trillions of years, let alone 2.5 million. In fact, under the laws of physics, it will age and wear, rot, and eventually fall apart. In order for such an engine to emerge, a designer possessing the knowledge and ability to develop it is essential.

Furthermore, there is an important fact that even evolutionist scientists are forced to admit: The main difference between the ape and human brains is not just a question of capacity and size. Materialists attempt to reduce all human characteristics, and thus the functioning of the brain, to matter. Yet it is today agreed that the features of the human soul cannot be reduced to matter. Man's ability to speak, think, decide, plan, his desires and wishes, his artistic and aesthetic abilities, his ability to possess ideologies, to produce ideas and to dream, and the virtues of love, loyalty, and friendship are not the product of the functioning of the brain. The human soul is something beyond matter, and that on its own is a challenge to materialism.

In his book, *The Mystery of the Mind: A Critical Study of Consciousness and the Human Brain*, the evolutionist neurosurgeon Dr. Wilder Penfield is forced many times to admit that the human soul cannot be accounted for in terms of the functioning of the brain. Some of these confessions read:

After years of striving to explain the mind on the basis of brain-action alone, I have come to the conclusion that it is simpler (and far easier to be logical) if one adopts the hypothesis that our being does consist of two fundamental elements [brain and mind (or soul)].⁴

I conclude that there is no good evidence . . . that the brain alone can carry out the work that the mind does.⁵

Therefore, comparing the ape brain to that of man avails the evolutionists not at all, since it is clear that no mechanism in nature

can give man the characteristics that make him human. It is God, the Lord of all the worlds, Who gives man his soul, creates him out of nothing, and makes him different from all other living things by breathing His spirit into him.

An Important But Ignored Subject: IT IS NOT THE EYE WHICH SEES

Although an important scientific truth is expressed in the BBC documentary, that truth is not emphasized in the way it should be. The documentary says: "Our eyes are only a window. It is our brain which sees around us. The eye merely forms the first stage."

This phrase, which one encounters in biology textbooks beginning in middle school, is actually very important, containing as it does a secret which can entirely alter a person's way of looking at the world.

People imagine they see the world with their eyes. The fact is, however, that the eyes and the cells which comprise them are merely responsible for turning the light reaching them from the outside, via chemical processes, into electrical signals. These electrical signals later arrive at the visual center at the back of the brain, which is where the image we see takes shape. For instance, someone reading these lines at this moment sees them in the visual center in the back of his brain. In other words, it is not actually the eyes that see. So, who is it that sees the image in the visual center and reads these words? Who is it that watches with excitement, joy, or sorrow the bright, colorful, three-dimensional image which forms within the darkness of the brain?

The same question also applies to the senses of hearing, taste, smell, and touch. Even as one listens to one's favorite song, it is not one's ears that are doing the hearing. Their task is merely to collect sound waves. The cells in the ears turn the sound waves reaching them into electrical signals, and forward them to the hearing center

in the brain. That favorite song is then heard there. You hear the voice of your best friend in your brain. But who is it that hears these sounds within the dark confines of the brain, enjoying the melody and rhythm?

The answer to these questions shows that every thinking human being possesses a soul. Another important point revealed by this scientific fact is this: Everything we see, hear, and touch throughout our lives is perceived in our brains. In other words, we can never actually see or touch the originals of things. What we are always in contact with is perceptions in the brain, and it is impossible ever to have direct experience of these objects by means of these perceptions. For that reason, everyone, even in a crowded room, is actually watching the perceptions in his brain, and is essentially alone.

As you drop off to sleep you might dream of yourself as listening to a concert with hundreds of other people. Yet as you listen to this music, you could actually be hearing it in a soundless garden. You can experience nothing beyond the perceptions reaching your brain. That applies when dreaming and in real life ...

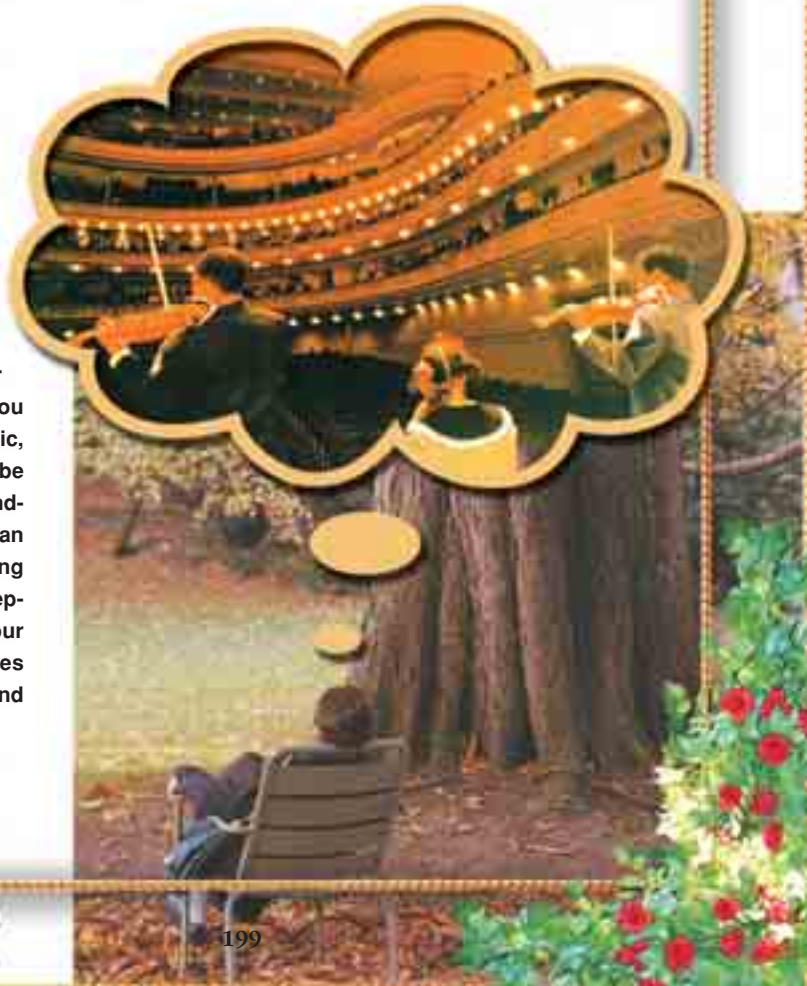

A DEFINITIVE REPLY
TO EVOLUTIONIST
PROPAGANDA

We may consider our dreams in order to arrive at a better understanding of this. Someone who dreams of attending a lecture in a packed hall is actually lying in bed alone. The image of the lecture forms within his brain. It is impossible for that person to realize he is dreaming until he wakes up, and he remains convinced that he is attending a real lecture.

The German psychiatry professor Hoimar von Ditfurth explains how we can never see the outside world:

No matter how we put the argument, the result doesn't change. What stands before us in full shape and what our eyes view is not the "world." It is only its image, a resemblance, a projection whose association with the original is open to discussion.⁶

Someone who exercises his mind a little will grasp this concept, which reveals the true nature of the life of this world and helps one realize just how hollow and meaningless the passions and desires aimed at this world truly are. The money in someone's wallet, the yacht he buys for millions of dollars, his holding company, and his new model car are all images which form within his brain. That individual can never touch or see the originals of these. All he perceives is images forming at the back of his brain. This is a scientific fact. The responsibility of all people of reason and good conscience



A person can easily see how meaningless all his desires regarding this world are when he stops to think a little. Nobody can ever actually really possess the car or house or position he thus desires. These are nothing but images in our brains. That being the case, someone who is aware of this must immediately turn to Our Lord, Who created him, and not be swept away by worldly desires.

is to grasp this concept before "waking from sleep," in other words before dying, and not to be deceived by becoming caught up in the life of this world.

You can find the details and scientific accounts of this great truth, which entirely alters one's perspective on life, on the website www.secretbeyondmatter.com, which contains the works of Harun Yahya, which have had such an enormous impact all over the world.

Conclusion

Characteristics peculiar to human beings, such as thinking, taking pleasure, having ideas, and feeling love, compassion, nostalgia, affection, joy, sorrow, happiness, and excitement, cannot be accounted for from a materialist and Darwinist perspective. These ideologies hold that all living things emerged by chance from inanimate matter, and they are totally unable to explain how it is that inanimate objects should one day have begun to possess the capacity for thought, decision-making, having ideas, and artistic and aesthetic taste.

1 - Charles Darwin, *The Origin of Species*, p. 75.

2 - Michael Denton, *Evolution: A Theory In Crisis*, London: Burnett Books, 1985, p. 330.

3 - Michael Recce and Philip Treleavan, "Computing from the Brain," *New Scientist*, Vol. 118, No. 1614 (May 26, 1988), p. 61

4 - Wilder Penfield, *The Mystery of the Mind: A Critical Study of Consciousness and the Human Brain* (Princeton, New Jersey: Princeton University Press, 1975), p.80

5 - Wilder Penfield, *The Mystery of the Mind: A Critical Study of Consciousness and the Human Brain* (Princeton, New Jersey: Princeton University Press, 1975), p. xiii

6 - Hoimar von Ditfurth, *Der Geist Fiel Nicht Vom Himmel* (The Spirit Did Not Fall From The Sky), p. 256



**THE EVOLUTIONIST
DECEPTIONS IN
THE DOCUMENTARY
THE SHAPE OF LIFE**

The first in the series of documentaries called *The Shape of Life*, jointly produced by the PBS and the National Geographic Society, was about the origin of animals (metazoans). The scientific deceptions contained in that documentary, which attempted to describe how the first multicellular organisms came into being, are set out below.

The Organization Within the Sponge Cannot be Explained by Evolution

At the beginning of the documentary there is an account of how one day, in some way, sponge cells living independently of one another took a decision among themselves to live together. In fact, in line with the familiar evolutionist scenario, the program even said that "in some way, the cells found a language to allow them to work together." Yet, the fact is that this imaginary account—the product of the evolutionists' own fantasy world—is a complete violation of the facts.

The origin of the organization in living things is one of the fundamental questions for which the theory of evolution can never offer a logical explanation. There is absolutely no reason for cells that can function independently of one another to begin to act together. Yet, the different cells in all multicellular organisms do work together towards a common purpose in an extremely organized manner. The sponge is one example of this flawless organization among cells.

Despite its very simple appearance, the sponge, an animal from the phylum *Porifera*, actually consists of exceedingly complex cells. These cells, organized in two layers, set up a continuous flow of water inside the sponge. On the one hand, the plankton in the water are filtered and digested; on the other, waste material is deposited into the flow and carried away. In this way, the sponge functions like a funnel in a specially established current.

The cells cannot have adopted the principle of working together by themselves. That is because they come into being already in pos-

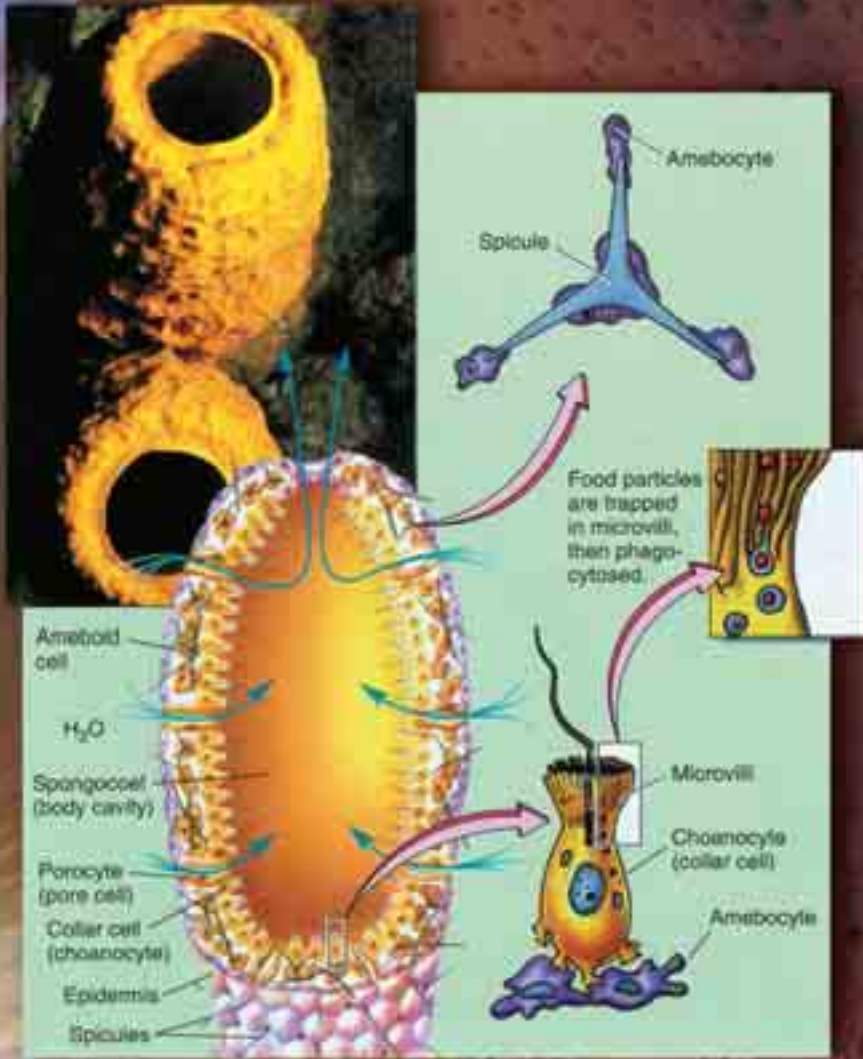

Sponges, which are regarded as having the simplest animal organization, are actually very complex. They attract scientists' attention because of their unusual cellular organization (the cells do not form tissues such as those found in other animals), their ability to regenerate lost parts, and their biochemical features (they have many compounds not known in other animals). This intricate design and perfect organization in such a simple-seeming organism as the sponge is evidence for God's incomparable creation.

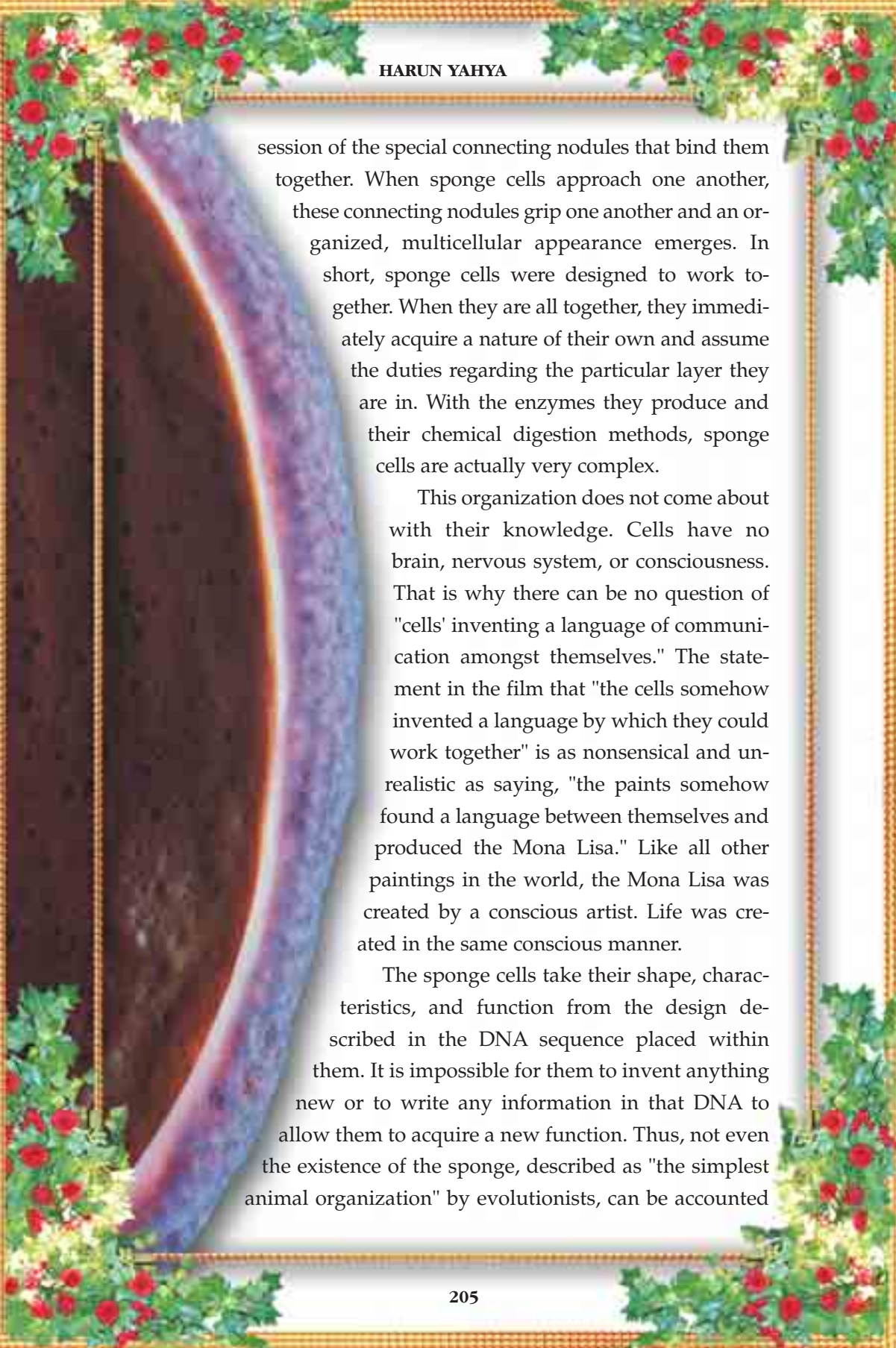

session of the special connecting nodules that bind them together. When sponge cells approach one another, these connecting nodules grip one another and an organized, multicellular appearance emerges. In short, sponge cells were designed to work together. When they are all together, they immediately acquire a nature of their own and assume the duties regarding the particular layer they are in. With the enzymes they produce and their chemical digestion methods, sponge cells are actually very complex.

This organization does not come about with their knowledge. Cells have no brain, nervous system, or consciousness. That is why there can be no question of "cells' inventing a language of communication amongst themselves." The statement in the film that "the cells somehow invented a language by which they could work together" is as nonsensical and unrealistic as saying, "the paints somehow found a language between themselves and produced the Mona Lisa." Like all other paintings in the world, the Mona Lisa was created by a conscious artist. Life was created in the same conscious manner.

The sponge cells take their shape, characteristics, and function from the design described in the DNA sequence placed within them. It is impossible for them to invent anything new or to write any information in that DNA to allow them to acquire a new function. Thus, not even the existence of the sponge, described as "the simplest animal organization" by evolutionists, can be accounted

for by a process of evolution. Like all living things, sponges are evidence of the fact of creation.

The Contradictions in DNA Comparisons Refute the Theory of Evolution

In the final part of the documentary, it is claimed that the sponge is the ancestor of all animals. This claim rests on a comparison of certain fundamental areas in the DNA sequences in living species with the same areas in the sponge DNA chain. In this way, the finding of similar DNA sequences is regarded as evidence of ancestral relationship by evolutionists.

The fact is, however, that this logic is invalid. DNA is a common language by which life is described. If we think of DNA as sentences which describe how a cell works, DNA consists of different sentences in which different words are used. The fact that the same words are encountered is the inevitable result of the fact that this coded language employs only four letters. To put it another way, the finding of similarities in DNA does not in any way show that living things had a common ancestor. This similarity is proof not of a "common ancestor," but of "common design." Every similarity we encounter proves the common aspect of the design in living things.

On the other hand, just the length of the DNA in the sponge is sufficient to invalidate the evolutionists' expectations. The DNA of the sponge, put forward as the "primal animal ancestor,"

consists of 1.8 billion base pairs (1.80pg.) According to the evolutionary family tree, the DNA of the tench (species *Tinca tinca*) should be a great deal longer than this, whereas in fact it is only half the length of sponge DNA, consisting of a mere 810 million base pairs (0.81pg.) The chicken, described as a much more advanced species than the sponge in the evolutionary family tree, also has DNA that is shorter, at 1.25 billion base pairs (1.25pg.)

As we have seen, the genetic facts are at total variance with the assumptions of the theory of evolution. As the scientific findings have shown, living species did not evolve from one another, but were created separately. (For further details regarding genetic comparisons and the theory of evolution, see <http://www.harun-yahya.com/refuted10.php>.)

Conclusion

The flawless design in living species invalidates the idea of the evolutionary process. Evolutionists are unable to account for even the emergence of a single cell by means of evolution, so it is meaningless for them to try to use evolution to explain the organization between those cells. Chance and unconscious atoms cannot produce superior design.

The DNA in cells is a description written in the same language in all the millions of different living species. The fact that the information is written in the same language does not support the claim that these species came about by chance and evolved from one another. On the contrary, it shows that they were created according to a common design. This is a scientific expression of the fact that God created all living things.

**EVOLUTIONIST DECEPTIONS
CONTINUE WITH THE
ARTHROPODS IN *THE SHAPE*
OF LIFE DOCUMENTARY**

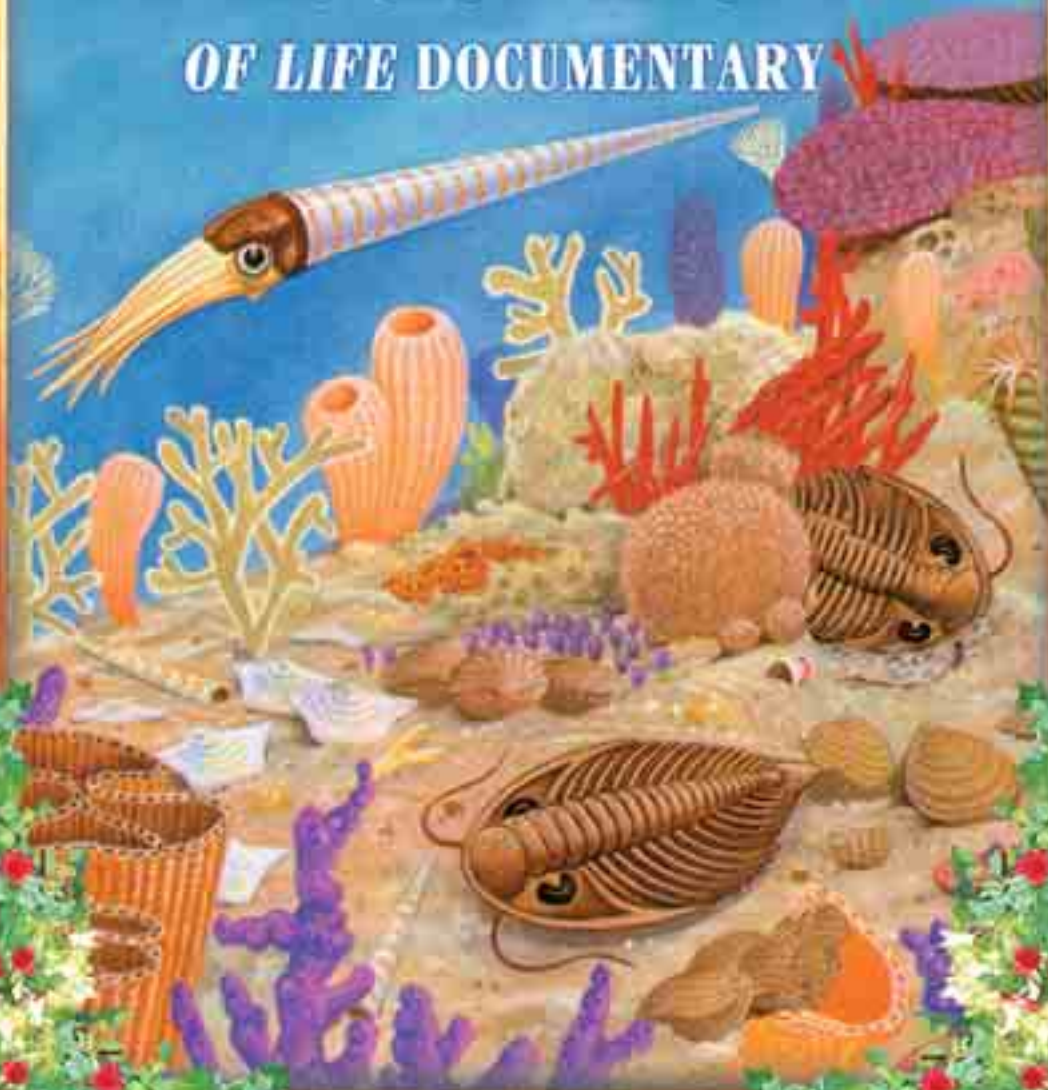

The "Conquerors" episode of the documentary *The Shape of Life* dealt with the arthropods, suggesting that these creatures made the transition from sea to land, and afterwards formed a separate taxonomic category by developing wings and beginning to fly.

Evolutionist scenarios that have been disproved countless times by scientific research and discoveries were repeated to the accompaniment of new images, with no evidence put forward to back them up. This article reveals the evolutionist propaganda that took place in this documentary, and briefly sets out the dilemma that the arthropods represent for evolution.

The Evolutionists' Cambrian Difficulties

The beginning of the film deals with living things which lived around 500 million years ago. This period, known as the Cambrian Age, was when organisms possessed of complex physical structures suddenly emerged. These are the "phyla," the most fundamental category of living creatures. In a most interesting way, nearly all the phyla that have existed on the earth emerged during the Cambrian period. Only a few phyla have been identified from before this period, whereas it has been estimated from the fossil record that the number of phyla appearing in the Cambrian was close to 100. The enormous jump in the variety of life at this time was so great that it is known in the scientific literature as the "Cambrian Explosion."

Richard Monastersky, a staff writer at *Science News* magazine, a popular evolutionist publication, provides the following information on the Cambrian Explosion:

A half-billion years ago, . . . the remarkably complex forms of animals that we see today suddenly appeared. This moment, right at the start of the Earth's Cambrian Period, some 550 million years ago, marks the evolutionary explosion that filled the seas with the world's first complex creatures.¹

The same article also quotes Jan Bergström, a paleontologist

**A DEFINITIVE REPLY
TO EVOLUTIONIST
PROPAGANDA**

who studies the early Cambrian deposits in Chengjiang, China, as saying, "The Chengyang fauna demonstrates that the large animal phyla of today were present already in the early Cambrian and that they were as distinct from each other as they are today.²

No organism has ever been found that the evolutionists might possibly put forward as an "ancestor" of the living things that emerged in the Cambrian Explosion. The creatures of the Cambrian

period emerged suddenly, and with flawless structures. This naturally demonstrates that creation was at the root of the Cambrian Explosion.

The British zoologist Richard

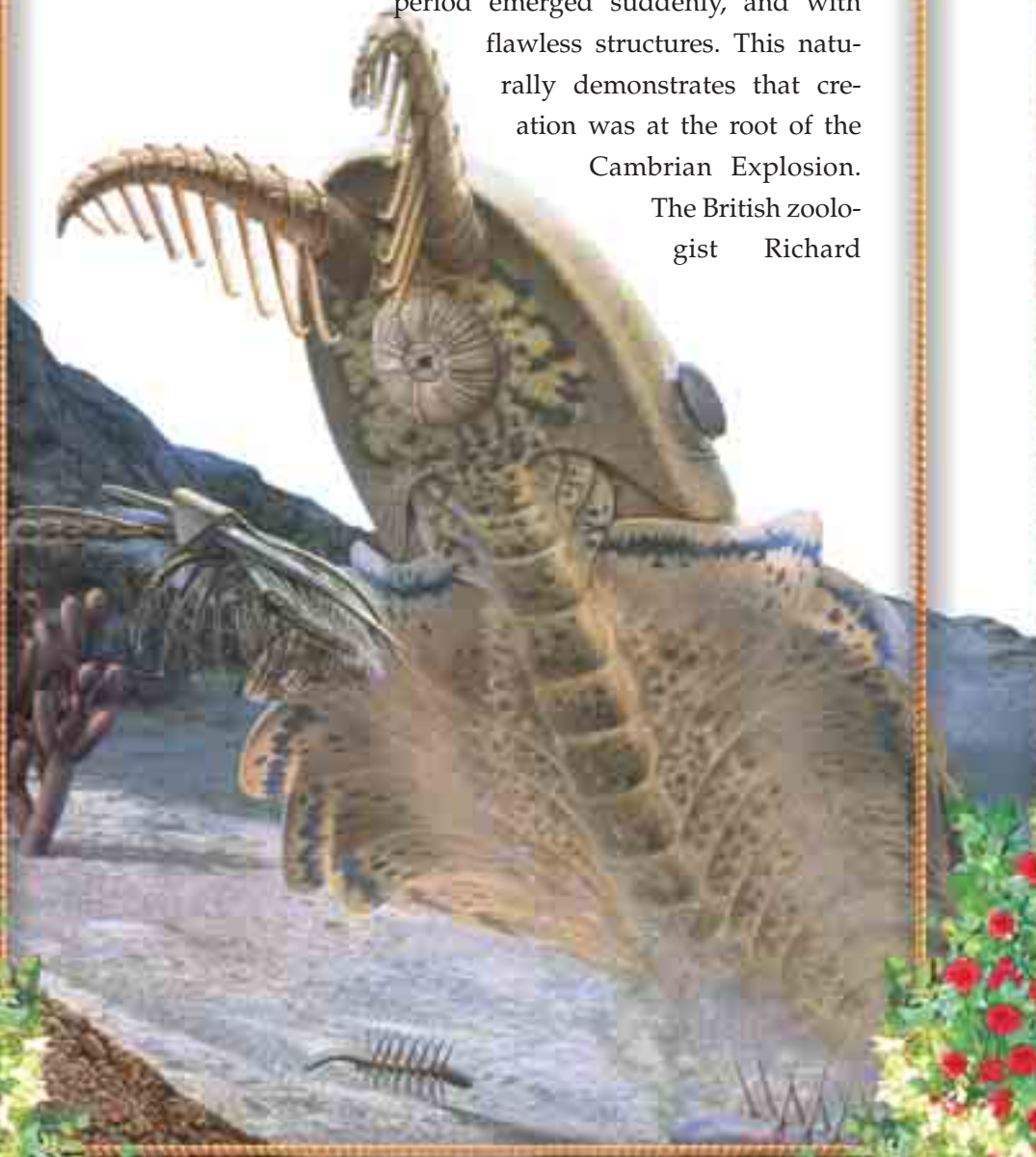

Dawkins, one of the most prominent defenders of Darwinism in the world, makes the following admission regarding the living things of the Cambrian:

For example the Cambrian strata of rocks . . . are the oldest ones in which we find most of the major invertebrate groups. And we find many of them already in an advanced state of evolution, the very first time they appear. It is as though they were just planted there, without any evolutionary history.³

Another aspect of the Cambrian period that totally undermines evolution is the fact that the number of phyla existing today is far fewer than the number that emerged during the "explosion." According to the theory of evolution, there should have been an increase over time in the number of categories of living things. Yet from the fossil record the situation is the exact opposite.

One of the world's most prominent critics of Darwinism is University of California Berkeley professor Phillip E. Johnson, who openly states the contradiction with Darwinism revealed by this situation in the following words:

Darwinian theory predicts a "cone of increasing diversity," as the first living organism, or first animal species, gradually and continually diversified to create the higher levels of taxonomic order. The animal fossil record more resembles such a cone turned upside down, with the phyla present at the start and thereafter decreasing.⁴

Not one word about this is mentioned in the documentary. There can be only one reason why a film that deals with how living things emerged on earth and then spread should ignore this huge explosion in the number of phyla and variety of living things. This explosion in the Cambrian Period definitively reveals that life came about not by chance but all of a sudden and in perfect form—in other words that it was created. The makers of the documentary deliberately avoided touching on the subject.

The Evolutionists' Major Deception Regarding Antennae and the Eye

Each and every one of the dead-ends facing the theory of evolution is ignored in the documentary. When the film, which looks at natural history from an evolutionist perspective, speaks of the arthropods, it resorts to totally fictitious Darwinist scenarios to account for the perfectly designed organs in these animals' bodies.

One of these organs is the arthropod antennae, which work together with a complex nervous system. For instance, the 15-30-cm-long antennae of lobsters are organs that can perform special scanning motions in the water and are equipped with sensitive tiny hairs capable of trapping chemicals. The claim put forward to account for the origin of such a complex organ is very far from explaining this multi-faceted design: "Arthropods developed a series of antennae to help them in their lives."

It is true that the arthropods' antennae make their lives easier. It is also true that there is a purpose behind their design. Yet, it is impossible for an arthropod, lacking all powers of reason, to have adopted an aim for itself and to have designed and developed a pair of antennae in the light of that aim. In the same way that we human beings do not "develop" eyes for ourselves but find them ready when we are born, so the arthropods did not develop their antennae but found them ready at their birth. That is because both eyes and antennae, and all other organs, were created. The PBS makes no mention of this fact, preferring instead the nonsensical claim that the animals developed their organs for themselves.

Another organ based on evolution according to the documentary, although no consistent evidence is given for its origin, is the eye. The eye contains light-sensitive cells that are found in no other organ of the body. The job of these cells is to transform light into electrical energy and to forward this to the brain. The eye also contains a lens system for focusing light.



Trilobites were among the first known animals with efficient eyes. These had many crystal lenses fixed at different angles to register movement and light from different directions. This 530-million-year-old compound eye structure is an "optical marvel" which worked with a double lens system. This fact totally invalidates Darwinism's assumption that complex eyes evolved from "primitive" eyes.

The trilobite, an arthropod from the Cambrian Period, has an eye whose design gives Darwinism a particularly serious blow. The compound eye design in these creatures is some 530 million years old, and just as perfect as visual systems from our own time. Some modern insects, such as bees and dragonflies, possess a very similar system.⁵ The fact that a system which functions flawlessly in our own time also existed in a nearly identical form 530 million years ago totally undermines the Darwinist hypothesis of evolution from the simple to the complex.

Moreover, the complex design in the eye also includes the feature of irreducibility. In order for the lens and the light-sensitive cells, as well as great many other organs, to do their jobs successfully, they need to exist in that precise form at the very same moment. According to evolution's own logic the eye will not work if just one of these elements is missing, and will thus atrophy and disappear. In short, the claims of Darwinism are in contradiction with

each other.

Yet, it is an evident truth that the design in the eye was intelligently created. The program attempts to cover up the fact that the origin of the eye is one of the greatest dilemmas facing Darwinism, and basically glosses over the matter by saying that the arthropods developed eyes with precise and complex structures to enable them to perceive images.

If somebody one day told you "Computers made fast CPUs for themselves in order to function better," you would think that claim was a very odd and nonsensical one. Computers cannot develop their own systems; only computer engineers can do that. The same thing applies to living things. Living things cannot provide themselves with brand new features. That is only possible by intelligent design. The only reason why this intelligent design is being ignored is the Darwinist theory and materialist philosophy to which those who ignore the concept of intelligent design are so blindly devoted (as well as the atheism that underpins both).

The method employed to cover up such matters with regard to the eye and antennae emerges when it comes to extensions such as pincers, with their own particular design. The documentary proposes that with a small evolutionary leap, legs can turn into pincers capable of gripping. This is a truly ridiculous claim. The designs in the leg and pincer are encoded in the creature's DNA. Different DNA sequences are needed for the leg and pincer. Furthermore, both sequences are based on information. It is impossible for this alleged change to have come about by mutations, which evolutionists try to portray as the basis of evolution. Mutations cause damaging effects in an organism, or at best have no effect at all. It is not possible for a random mutation to add to DNA the necessary information for a leg and so regulate the system. Indeed, such a change has never been observed.

In fact, the documentary is filled with such evolutionist fairy tales from beginning to end. This statement is particularly striking from the point of view of revealing the deceptive style that domi-

Among His signs is the creation of the heavens and earth and all the creatures He has spread about in them. And He has the power to gather them together whenever He wills. (Qur'an, 42: 29)



nates the film: "It can be seen that the arthropods possessed an unbelievable evolutionary and developmental ability."

This, as we have made clear above, is the equivalent of saying that computers possess an unbelievable evolutionary ability. The only fact underlying this nonsense is the prejudice of the filmmakers in the face of that truth that all living things were created.

The Evolutionists' Spider Web Deception

Another important deception in the documentary concerns the spider web. It is alleged that the web emerged later in evolution, together with baseless claims that spiders' desires to catch flying creatures may have been influential in the web's origin.

It must first of all be made clear that, as has been explained above, living things' "desires" cannot possibly cause them to acquire new organs or physical attributes. No matter how much you and your descendants "wish" to fly, no matter how much you make that desire a part of your inner being, you will still never grow wings. Living things' physical features are encoded in their genes, and no "desire" can affect those genes. The style adopted by the documentary as it ignores this fundamental truth is an odd, unscientific, and fantastical one.

Moreover, someone who closely examines the spider's web can clearly see that it is the work of design, not of "evolution by chance." The spider's web is a substance that material scientists take as a model. Weight for weight, it is five times more resistant than steel. The production of steel bulletproof vests has been made possible by imitating the spider's web. Furthermore, the spider's web exists as a liquid inside the animal's body, undergoing a reaction as soon as it meets the air and becoming stiff. The spider is thus capable of consuming its web whenever it wishes and storing it for subsequent use.

The way spiders spin their webs also rests on the most intelligent techniques. They use trees or plants as props and build their webs around them. Spinning concentric links that move in towards



Three-dimensional webs have a much more complicated structure than two-dimensional ones. A miraculous structure can be observed in every feature of the web. They, like all other creatures, behave only in accordance with the inspiration God has given to them from birth. This is the only cause of their architectural wonders.

the center, they build an invisible snare and also a secure nest for themselves.

The fact that the web possesses all these features and that the spider possesses the ideal characteristics to make use of the web, is a miracle—one which Darwinism can never account for. It once again shows us that the origin of life is creation.

The Scenario of the Scorpion Moving from Water to Land

One of the utterly baseless evolutionist claims made in the documentary "The Conquerors" concerns the transition from water to land. The film does not put forward any substantial evidence for

**A DEFINITIVE REPLY
TO EVOLUTIONIST
PROPAGANDA**

Like all other evolutionist accounts about transition from water to land, the claim about scorpion's transition from water to land also has no basis. When we examine the huge anatomical and physiological differences between water- and land-dwelling creatures, we can see that these differences could not have disappeared in an evolutionary process with gradual changes based on chance.

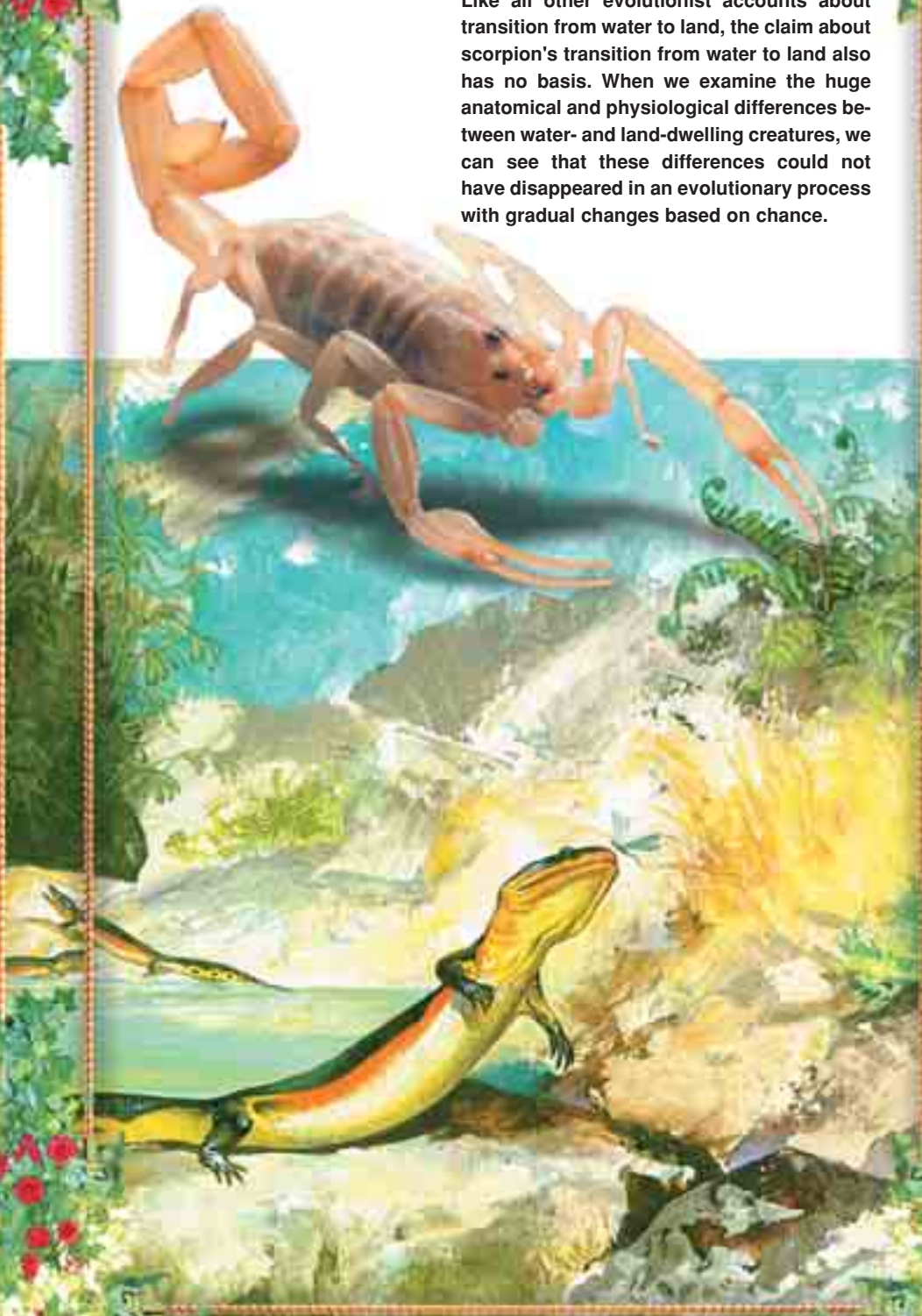

this transition but covers up this subject with common tactics used by evolutionists. The only example given in this area concerns an organ that the scorpion's imaginary ancestors are assumed to have possessed called the "wing," which allowed them to breathe under water. It is suggested that over time this organ became buried inside the body and gained the ability to take in oxygen from the air. However, not one fossil was shown to back up this claim, and the account was stranded on the level of fantasy.

Conclusion

The Cambrian Explosion shows that no such process as evolution ever occurred in natural history. It can be seen that such complex structures as the eye and antennae possess an astonishing design that can never be accounted for by random mutations. The spider's web indicates that even tiny animals possess a superior design that engineers seek to emulate, and demonstrates that the design in nature is so superior that it could never have come about by chance.

In short, Darwinist propaganda does not reflect the scientific facts. The scientific truth is that the arthropods and all the millions of other living species are the product of an intelligent design.

1. Richard Monastersky, "Mysteries of the Orient," *Discover*, April 1993, p. 40.
2. Richard Monastersky, "Mysteries of the Orient," *Discover*, April 1993, p. 40.
3. Richard Dawkins, *The Blind Watchmaker*, London: W.W. Norton, 1986, p. 229.
4. Phillip E. Johnson, "Darwin's Rules of Reasoning," *Darwinism: Science or Philosophy?* by Buell Hearn, Foundation For Thought and Ethics, 1994, p. 12.
5. R.L. Gregory, *Eye and Brain: The Physiology of Seeing*, Oxford University Press, 1995, p. 31.

A detailed illustration of a prehistoric scene. In the foreground, a blue and white spotted dinosaur stands on a sandy bank, looking towards a pond. To its left, a pterosaur is perched on a rock. The pond reflects the surrounding greenery and palm trees. The background shows a hazy landscape with more palm trees. The entire scene is framed by a decorative border of red and white flowers and green leaves.

**THE EVOLUTIONISTS
ARE STILL STRUGGLING WITH
THE SAME DILEMMA:
THE ORIGIN OF FLIGHT**

The dino-bird myth once again entered the agenda in an article titled "Wing Assisted Incline Running and the Origin of Flight" in the January 17, 2003, edition of the journal *Science*. A biologist by the name of Kenneth P. Dial, from the University of Montana, offered a new interpretation of the theory that dinosaurs evolved into birds. His claim was widely reported in the world press, although he offered not one concrete, scientific piece of evidence to support the thesis that birds evolved from dinosaurs. Dial's claim came nowhere near accounting for the complex design in birds, and did not go beyond providing a new story for the dino-bird myth.

This article will reveal the scientific deceptions in Kenneth Dial's evolutionist claims by describing the fossil discoveries and the complex design upon which flight is based.



Dial's Research

Dial's claim rests on certain observations of the *Alectoris chukar* species of partridge. One feature of these birds is that they prefer to run up a steep incline or tree trunk rather than fly. As they run, they also flap their wings to gain speed. This short-distance running was given the name Wing-Assisted Incline Running (WAIR).

During WAIR, as the partridges run up the slope, they both use their feet and flap their wings, thus reducing the effect of gravity. Their feet are designed in such a way as to cling to the ground, and their wings function like the ailerons on a racing car. As a result of Dial's research, he observed that chicks possessed almost the same WAIR ability as adult birds. He described how within four days of hatching birds were able to climb up 45 degree inclines in this manner, and that their still-growing wings had an aerodynamic effect during this sprint.

A number of experiments were conducted on these developing wings, and Dial saw that the aerodynamic effect on wings with shortened feathers decreased. Birds with

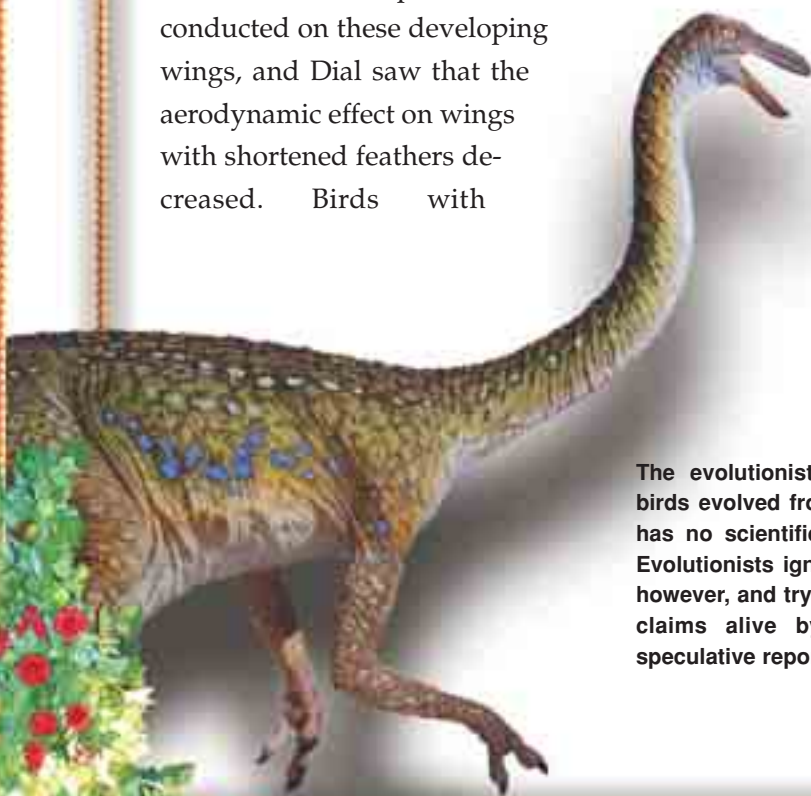

The evolutionists claim that birds evolved from dinosaurs has no scientific basis to it. Evolutionists ignore this fact, however, and try to keep their claims alive by means of speculative reports.



trimmed feathers were unable to climb as well as birds whose feathers had not been trimmed.

Dial, an evolutionist, maintains that the origin of birds goes back to dinosaurs of the theropod subgroup. He favors the idea that dinosaurs are the ancestors of birds and tries to place his observations of the partridge uphill sprint somewhere into the illusory dino-bird evolution. According to the scenario he came up with, dinosaurs trying to escape from predators flapped their forearms when running on inclines in order to gain speed, and these forearms thus gradually turned into wings. This scenario is totally devoid of any scientific foundation, although he sought to use it as evidence for the imaginary transition from dinosaur to bird.

It is clear that Dial's claim rests on nothing more than imagination. Showing that he was able to reduce the aerodynamic properties of birds' feathers by shortening them brings with it absolutely no scientific explanation of the way that dinosaurs allegedly came to be able to fly. This is nothing but trickery of the kind put forward by many other evolutionists seeking to instill the imaginary dino-bird model in people's minds.

The fact that such a claim was made by a scientist and published in a scientific journal might deceive some people into thinking that such stories possess some kind of scientific basis. The fact is, however, that scientific research actually disproves the dino-bird theory,

for which no evidence has ever been forthcoming. Scientific findings in the fields of paleontology, developmental biology, physiology, and anatomy in particular clearly reveal that Dial's claim is nothing more than a fantasy. In addition, a number of advances in the technological arena show that flight and flying creatures have been specially designed. This fact eliminates the evolutionists' groundless and invalid claims that living things evolved as the result of a series of coincidences.

Paleontology

The defenders of the dino-bird theory regard the theropods, a small, carnivorous species of dinosaur, as the ancestor of the birds. Evolutionists particularly stress a certain fossil species of this type found in the Liaoning region of China in this connection. However, they ignore one important truth: At a time when there were still no

Darwinists hold that some small dinosaurs, such as *Velociraptors* or *Dromaeosaurs*, evolved by acquiring wings and then starting to fly. Thus, *Archaeopteryx* is assumed to be a transitional form that branched off from its dinosaur ancestors and started to fly for the first time. However, the latest studies of *Archaeopteryx* fossils indicate that it is absolutely not a transitional form, but an extinct species of bird, having some insignificant differences from modern birds.



theropod dinosaurs, which they suggest were the ancestors of birds, birds capable of normal flight were already in existence on the earth. *Archaeopteryx*, an ancient species of bird that lived 150 million years ago, is millions of years older than the theropod species of dinosaurs. Despite being an evolutionist, the well-known ornithologist Dr. Alan Feduccia is known for his recognition of the scientific dilemma facing the dino-bird theory. Feduccia has stated that *Archaeopteryx* represents an "insurmountable problem" from the point of view of evolution:

There are insurmountable problems with that theory... Beyond what we have just reported, there is the time problem in that superficially bird-like dinosaurs occurred some 25 million to 80 million years after the earliest known bird, which is 150 million years old.¹

The fact that a creature should have emerged 25 million years before its ancestor is an inexplicable situation from the Darwinists' point of view. The existence of the *Archaeopteryx* fossil alone is sufficient to invalidate the dino-bird theory. Discoveries in the field of developmental biology, which studies the development of living things, also point to the invalidity of the dino-bird theory.

Developmental Biology

The latest research by Dr. Alan Feduccia and Julie Nowicki of the University of North Carolina at Chapel Hill studied the development of ostrich eggs. Feduccia compared the hand digits in ostrich embryos with those of dinosaurs of

the theropod species, and revealed that birds and theropods had a different thumb order. The following discussion of this research appeared on the website of the American Association for the

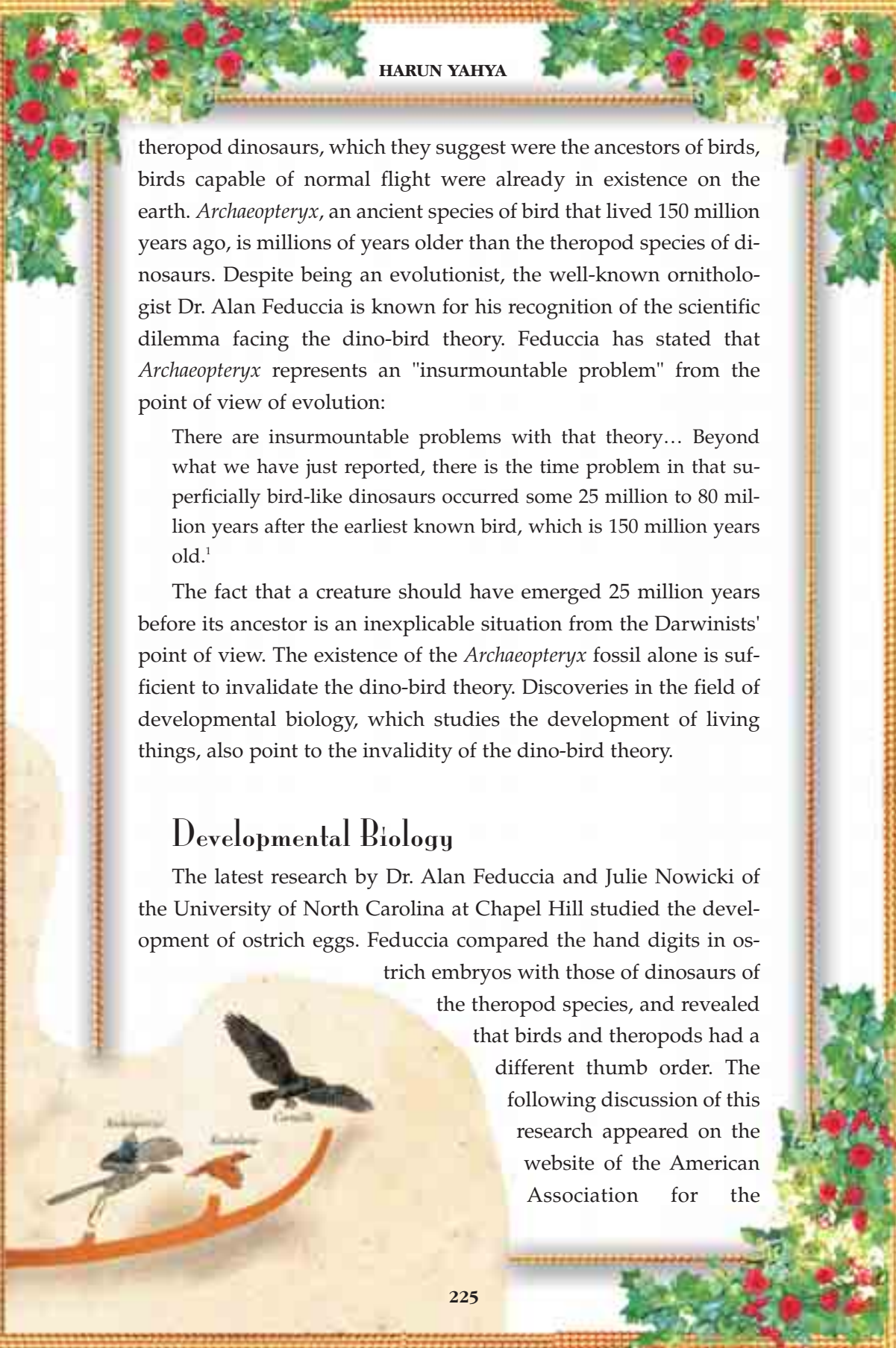

**A DEFINITIVE REPLY
TO EVOLUTIONIST
PROPAGANDA**

Advancement of Science (AAAS):

"Whatever the ancestor of birds was, it must have had five fingers, not the three-fingered hand of theropod dinosaurs," Feduccia said. Scientists agree that dinosaurs developed 'hands' with digits one, two and three... "Our studies of ostrich embryos, however, showed conclusively that in birds, only digits two, three and four, which correspond to the human index, middle and ring fingers, develop, and we have pictures to prove it," said Feduccia, professor and former chair of biology at UNC. "This creates a new problem for those who insist that dinosaurs were ancestors of modern birds. How can a bird hand, for example, with digits two, three and four evolve



Despite being an evolutionist himself, Alan Feduccia opposes the thesis that birds evolved from dinosaurs. By studying the development of the pentadactyl forelimbs of ostrich embryos in the egg he once again revealed the impossibility of the evolutionists' claims.



from a dinosaur hand that has only digits one, two and three? That would be almost impossible." ...²

Another well-known bird expert who opposes the dino-bird theory is Larry Martin of Kansas University, who states that the theory has no consistent, defensible element at all:

To tell you the truth, if I had to support the dinosaur origin of birds with those characters, I'd be embarrassed every time I had to get up and talk about it.³

Physiology

Dinosaurs are members of the reptile family. When birds and reptiles are examined it can be seen that their physiologies are very different. First and foremost, birds are warm-blooded and reptiles cold-blooded. The cold-blooded reptile metabolism works slowly. Birds, on the other hand, consume a great deal of energy in a tiring activity such as flying. Their metabolisms are much faster than those of reptiles. Birds have to carry oxygen to their cells very quickly, which is why they are equipped with a special respiratory system. Air travels in only one direction in their lungs, thus not delaying the organism's supply of oxygen. In reptiles, on the other hand, the air taken into the body leaves it by the same channels. Unidirectional flow is found only in the bird lung, and is a unique design. It is impossible for such a complex structure to have come about in stages. That is because this unidirectional flow system and the lung itself need to exist in perfect form at all times in order for the creature to survive. Michael Denton, a biologist known for his criticisms of Darwinism, has this to say on the subject:

Just how such a different respiratory system could have evolved gradually from the standard vertebrate design without some sort of direction is, again, very difficult to envisage, especially bearing in mind that the maintenance of respiratory function is absolutely vital to the life of the organism.⁴

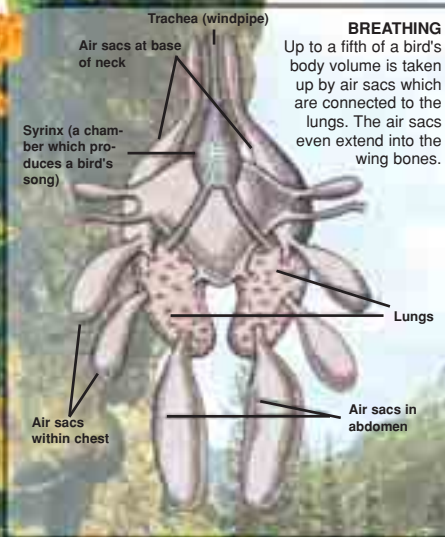

Thanks to special air sacs all along the passages between them, air always flows in one direction through the avian lung. In this way, birds are able to take in air nonstop. This satisfies their high energy requirements. The avian respiratory system is a marvel of design, specially created to meet the bird's need for high levels of oxygen during flight.

Anatomy

Birds possess a special anatomy that allows them to fly. The bones play an important role from the point of view of flight. They need to be both strong and light. Bird bones are hollow, but strong enough to hold the skeleton together. Yet, in reptiles the bones are heavy, and not hollow.

Dr. Feduccia has said the following about the anatomical differences between birds and dinosaurs:

Well, I've studied bird skulls for 25 years and I don't see any similarities whatsoever. I just don't see it... The theropod origins of birds, in my opinion, will be the greatest embarrassment of paleontology of the 20th century.⁵

As well as their bones, birds' wings also possess a special design not found in any other living thing. As well as their light bones, their feathers also play an important role in the aerodynamic properties of the wing. Dr. Andy McIntosh, a professor in Combustion Theory at Leeds University, UK and an aerodynamicist, described the superior design in feathers during an interview:

Bird flight in particular is remarkable; consider feathers. If you look at a feather under a microscope, you see the main stem, with barbs coming out to the left and right, and from these you have left-and right-handed barbules. Now the interesting bit is that the left-handed ones have hooks, and the right-handed ones have ridges... The feather is made such that if you bend it, everything bends with it, and yet it's a very light structure. So the hooks catch the ridges and they slide over the ridges—it's a mechanical engineer's dream to have such useful, lightweight engineering. But if you have a sliding joint, you need lubrication. To do this the bird twists its neck around 180° and dips its beak into a tiny oil gland right down at the back of its spine. It then preens itself, wiping this oil all over its feathers, so that they join together nicely, and these sliding joints are oiled. That's a marvellous bit of engineering.⁶

**A DEFINITIVE REPLY
TO EVOLUTIONIST
PROPAGANDA**



Dr. McIntosh finds the idea unscientific that feathers with such a superior design have evolved and not been created by an intelligent design:

I have seen a photo in a book, of an aircraft landing at Hong Kong and underneath it is a falcon landing at the same time. Now as you look at birds and planes together, are you going to say that one is designed and the other isn't? I would find that scientifically preposterous.⁷

When bird feathers are studied closely, a very delicate design emerges. To claim that the complex design in feathers could have come about by the evolution of reptile scales is quite simply a dogmatic belief with no scientific foundation.

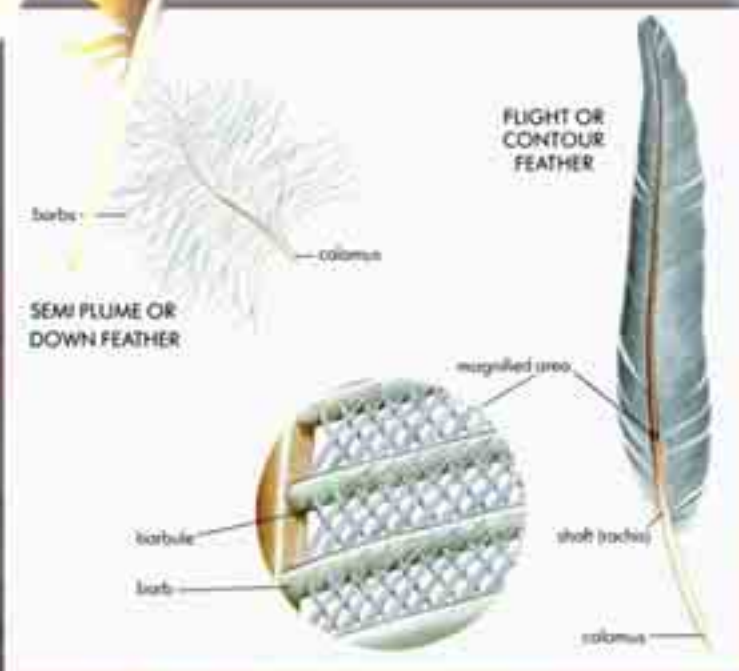

The Irreducible Complexity in Birds' Wings Refutes Gradual Evolution

All these scientific facts invalidate the dino-bird evolution scenario. When the complex design in the bird wing is considered, it once again emerges that it is impossible to account for flight in terms of random evolution. The most important fact demonstrating this is the irreducible complexity in this perfect design. Accepting the hypothesis of the evolution of flight means accepting that wings were inadequate at certain stages. Yet an inadequate "wing" is inadequate for flight at all. In order for flight to take place, the creature's wings need to be flawless and fully formed. The Turkish evolutionist biologist Engin Korur makes the following admission on this point:

The common feature of eyes and wings is that they can only perform their functions if they are developed as an entire entity. To put



NON-STOP FLIGHT

The swift's long, curved wings enable it to fly continuously at an average speed of about 40 kph (25 mph)

Long outer
wing feathers

SWIFT WING



Short inner
wing feathers



SWIFT FLIGHT

The swift alternates fast wingbeats with short glides.

KINGFISHER WING



Waterproof flight
feathers

Down feathers



Kingfisher

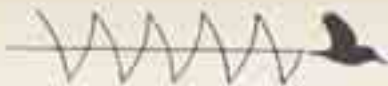

SPEED IN BURSTS

The kingfisher's fast but short flight is achieved on stubby triangular wings. This wing shape helps the bird to take off from the water after a dive.

KINGFISHER FLIGHT

Whirring wingbeats carry the kingfisher between perches. It can brake in mid-air to dive for fish.

it another way, a creature cannot see with a deficient eye, nor fly with half a wing. How these organs came about remains a still unexplained secret.⁸

Kenneth Dial's thesis that WAIR accounts for the evolution of the wing is invalid in the face of these facts. According to his imaginary scenario, dinosaurs' arms would prove inadequate in several stages of this so-called evolution, and flight could not happen. To believe that a bird developed in stages means accepting that all the complex structures and systems described above—the design of the unidirectional flow of air in the lungs, hollow bones, the hooks and barbs on the feathers, the light but flexible structure, the bird's warm-blooded metabolism, and many other details indicative of a perfect design—also came about in stages. It is of course impossible for any creature in which these organs and systems were in any way lacking to have survived at all.





The Perfect Flight Systems and Technology in Living Things

It is impossible to account for the design in birds and the flight motion dependent on that design in terms of evolution. Flight possesses the most complex aerodynamic properties, both in birds and in insects. The control of flight in birds and insects requires a nervous system capable of flawlessly controlling the creature's muscles. In this system, known as neuromuscular control, the nerve cells are in constant communication with the muscle cells. After contracting with the instructions received from the nerve cells, the muscles send back a signal reporting their contracted state. When a bird rises, glides, or descends, this system is ready to provide the necessary aerodynamics.

The perfect flight systems in birds and insects is a source of inspiration for engineers, who try to create the most productive designs with the best materials for the lowest cost, and who have begun to imitate this superior design in nature. For instance:

Like bird bones, the interiors of airplane wings are hollow. There are long, thin supports between the internal faces of the bone in order to maintain resistance. In flight engineering, similar struts inside the wing serve the purpose of a skeleton in the face of sudden and severe air currents. Known as the "Warren's truss," it has been copied from birds.⁹

The flaps on the plane wing used to control the plane's attitude have been set out to imitate the movement of the bird's wings as it comes in to land.



Birds' skeletal structure is employed in designing airplanes, bridges and modern structures.

SPECIALIZED BONE STRUCTURE OF THE BIRDS



Unlike dinosaur and reptile bones, bird bones are hollow. This gives the body stability and lightness.



UNIQUE FLYING TECHNIQUES OF THE BIRDS

Narrow, tapering wings



Swallow

Massive wingspan



Albatross

Long, elegant wings



Tern

Feathered fingers



Eagle

Backward-pointing wings

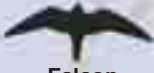

Falcon

Short, rounded wings



Sparrowhawk

The size and shape of each bird are created in a way to enable them to hunt and fly in the easiest way possible. Unique wing shapes of birds are perfect examples of God's immaculate creation.

The shape of the nose in birds and planes is such as to reduce air resistance.

The ability of modern-day planes to make sudden maneuvers in the air is much less than that of birds. The understanding of the aerodynamic systems of birds in flight is of the first importance in the production of more maneuverable planes. That is in fact the reason for the funding received for Kenneth Dial's study described above. William Zamer of the American National Science Committee, which funded the research, says, "The results may also one day help humans design better vehicles for both land and air travel."¹⁰ This reveals just how superior the aerodynamic control ability in partridges is.

Despite being much smaller than birds, insects have also fascinated those engineers who have studied the way they fly. For example, a fly can flap its wings an average of 500 times a second, and can instantaneously change direction. The superior design in the dragonfly, which can remain suspended in the air or suddenly change direction at high speed, was imitated in the design of the American Sikorsky helicopter.

Engineers trying to imitate insect flight encounter a major difficulty here. Fly wings rotate in the air in a figure-eight pattern. The surface of the wing points upwards in the first half of the rotation and down in the second half. In order to imitate this, jointed rotating wings would need to be mounted on a plane. Even harder than that is the computer system to allow such wings to move rapidly and in a controlled manner. The construction of such a system is beyond our wildest dreams with the current level of our technology. The greatest dream of engineers imitating insect flight is to be able to create robot insects whose flight can be controlled in narrow corridors and rooms. Experts working in high technology institutes in America state that in terms of imitating insect flight they regard themselves as being at the level of the Wright brothers in 1903.¹¹



The flight system of the dragonfly, which is a wonder of design,

inspired many scientists to make use of its workings in aeronautics.

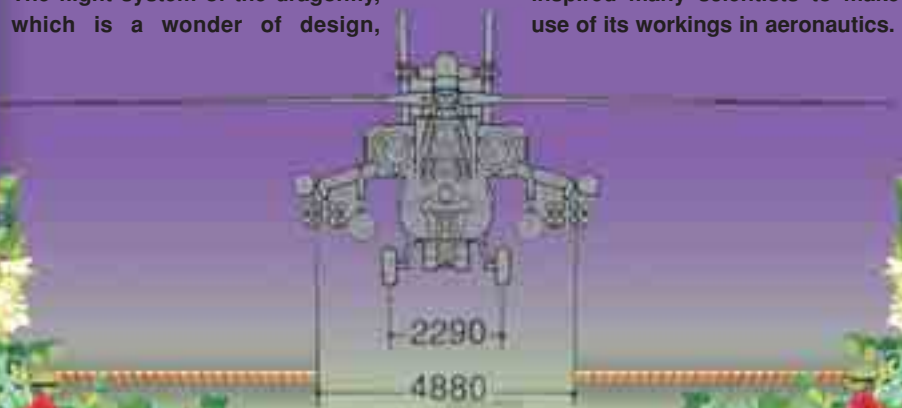

Conclusion: Flight is a Complex Motion God has Created

The fact that scientific discoveries have invalidated the evolutionist scenarios of flight, the existence of irreducibly complex systems in flying organisms, and finally the fact that the design in these creatures is in many ways far above the level of technology reached by man, all unquestionably prove that flight came about not by chance but by conscious creation. The fact that evolutionary scenarios are still stubbornly kept on the agenda is nothing else than a despairing effort by those who refuse to accept the truth of creation and who are blindly devoted to Darwinism.

Not one evolutionary scenario put forward by Darwinists has any scientific foundation or constitutes a true scientific explanation, and in fact scientific findings place evolution in an impasse. All sci-

entific discoveries clearly show that flight was specially created. This superior creation is the work of God. The fact that the flight of a fly cannot be copied technologically is in one of His verses:

Mankind! An example has been made, so listen to it carefully. Those whom you call upon besides God are not even able to create a single fly, even if they were to join together to do it. And if a fly steals something from them, they cannot get it back. How feeble are both the seeker and the sought! (Qur'an, 22: 73)

1. David Williamson, "Scientist Says Ostrich Study Confirms Bird 'Hands' Unlike Those Of Dinosaurs," *EurekAlert*, 14-Aug-2002, http://www.eurekalert.org/pub_releases/2002-08/uonc-sso081402.php
2. David Williamson, "Scientist Says Ostrich Study Confirms Bird 'Hands' Unlike Those Of Dinosaurs," *EurekAlert*, 14-Aug-2002, http://www.eurekalert.org/pub_releases/2002-08/uonc-sso081402.php
3. Pat Shipman, "Birds Do It... Did Dinosaurs?," *New Scientist*, February 1, 1997, p. 28
4. Michael J. Denton, *Nature's Destiny*, Free Press, New York, 1998, p. 361.
5. Pat Shipman, "Birds Do It... Did Dinosaurs?," *New Scientist*, February 1, 1997, p. 28
6. "Flying High," An interview with Dr. Andy McIntosh, http://www.answersingenesis.org/home/area/magazines/docs/v20n2_mcintosh.asp
7. Ibid.
8. Engin Korur, "The Secret of Eyes and Wings," *Bilim ve Teknik* (Science and Technology), October 1984, No: 203, p. 25.
9. "Flying High," An interview with Dr. Andy McIntosh, http://www.answersingenesis.org/home/area/magazines/docs/v20n2_mcintosh.asp
10. "Study: Frantic Flapping May Have Led to Flight," *ABCNews*, January 16, 2003, http://abcnews.go.com/wire/SciTech/reuters20030116_443.html
11. "Robotic Insect Takes to the Air," Dr.Chris Riley, *BBCNews*, April 11, 2001, <http://news.bbc.co.uk/2/hi/science/nature/1270306.stm>



**NEW FOSSIL FISH DISCOVERIES
POSE A NEW DILEMMA FOR
THE THEORY OF EVOLUTION**

The February 21, 2003, edition of the journal *Science* carried an article called "Separate evolutionary origins of teeth from evidence in fossil jawed vertebrates." Based on studies of a number of fish fossils from the Devonian Period, it was suggested in the article that teeth may have evolved at least twice. The aim of this paper is to set out the inconsistent aspects of this claim.

Written by craniofacial development researcher Moya Meredith Smith and paleontologist Zerina Johanson, the article begins by considering the origin of the fish known as placoderms according to the theory of evolution. *Placodermi* is the name of a class of jawed fish that disappeared during the Devonian Period (between 408 and 360 million years ago). This class is regarded in the imaginary evolutionary family tree as the ancestor of all jawed vertebrates. In the current evolutionist literature, it is considered that these fish had no teeth, and that teeth only evolved after the jaw, and thus in the vertebrates which came after the placoderms. However, in the *Science* article Smith and Johanson state that they have encountered a situation, which changes this. The researchers go on to say that they have encountered real teeth containing dentine in certain fossils belonging to some groups of the *arthrodira* family of the order placodermi (*Eastmanosteus*, *Gogopiscis gracilis*, *Compagopiscis croucheri*). This represents a new dilemma for the theory of evolution, because it appears that an organ as complex as the tooth emerged in a period far older than evolutionists had hitherto believed. This, in turn, leaves evolutionists a far narrower period of time in which to engage in speculation regarding the so-called evolution of teeth, and thus represents an enormous quandary for the theory itself.

Another problem this new finding represents for the theory of evolution is that evolutionists are now obliged to maintain that teeth evolved not once, but two separate times. In their *Science* article, Smith and Johanson claim that teeth might have originated three or more times among jawed vertebrates. This reveals that evolutionists, who in any case support a totally indefensible scenario

(namely, the illogical claim that a complex design such as that in teeth could be the work of chance mutations), are now obliged to propose that this scenario actually took place many times.

Let us also recall here that evolutionists already face an insuperable dilemma when it comes to the origin of fish: It has been calculated that the fossil fish *Haikouichthys ercaicunensis* and *Myllokunmingia fengjiao* found in China in 1999 are some 530 million years old. That figure takes us back to the exact middle of the Cambrian Period, when just about all the known animal phyla emerged. The fact that the origins of fish stretch this far back—this discovery pushes their origins back by some 50 million years—demonstrates that fish emerged at the same time as the invertebrate sea creatures that are supposed to have been their ancestors, which in turn deals a lethal blow to the evolutionary "family tree."

In short, the fossil research on the origin of fish represents an insuperable problem for the theory of evolution. The evidence continues to clearly show that the origin of fish and all other living things is not evolution, but creation.

Everything in the heavens
and earth belongs to Him.
Everything is obedient to
Him. (Qur'an, 2: 116)



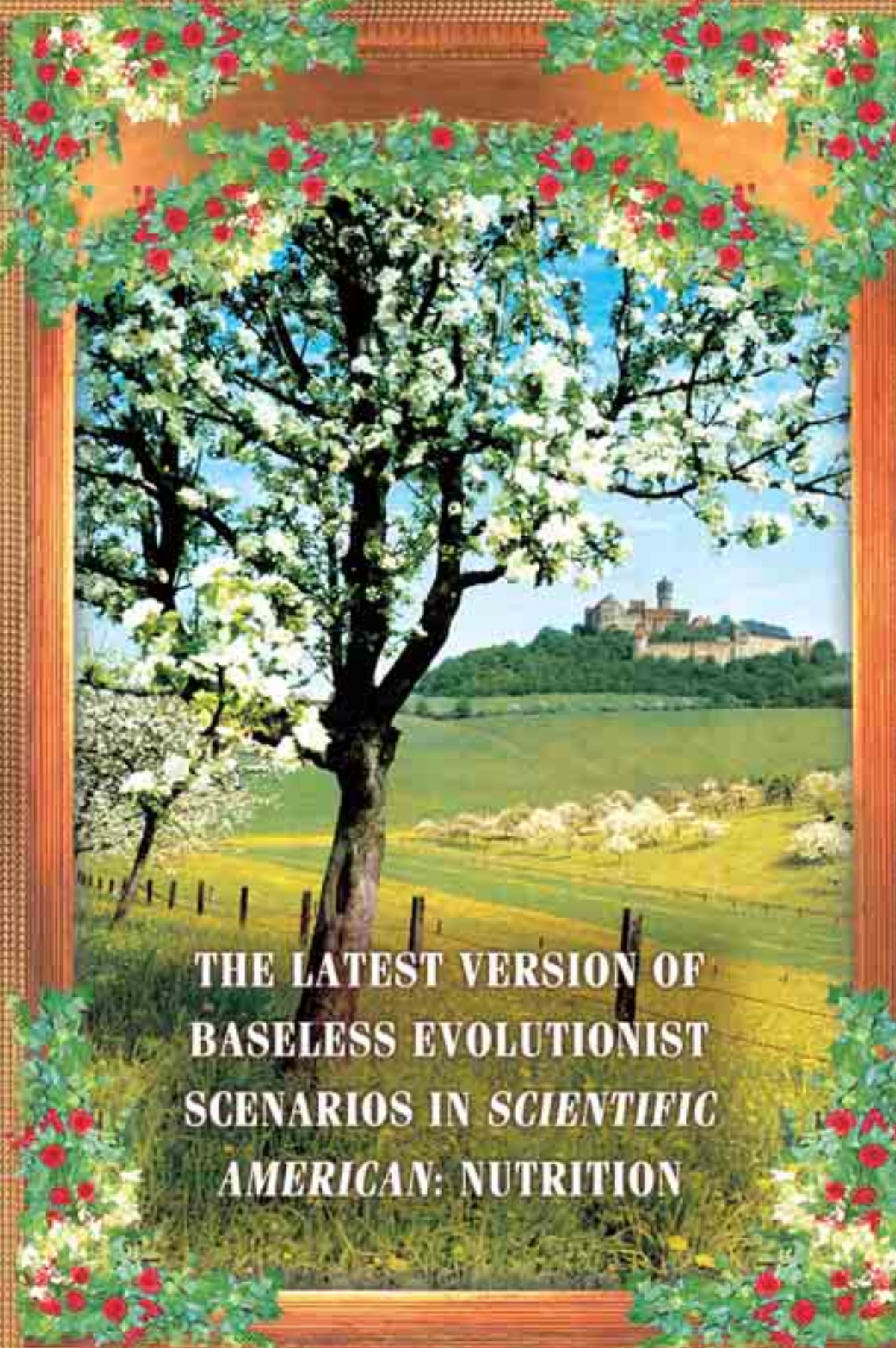

**THE LATEST VERSION OF
BASELESS EVOLUTIONIST
SCENARIOS IN *SCIENTIFIC
AMERICAN: NUTRITION***

In the December 2002 edition of *Scientific American* magazine, an article under the headline "Food for Thought," by William R. Leonard, appeared which spoke of man's being a so-called evolved species of animal and attempted to form a link between his nutritional needs and traditions, on the one hand, and evolution, on the other. By means of this article, which was based solely on the speculation of evolutionist scientists and offered no scientific evidence whatsoever, it was suggested that man is a species of animal that has come about by chance.

This article in *Scientific American* contains deceptions ill-befitting a serious scientific journal. When we look at the kind of exposition prevailing in the article and the pictures offered alongside the text, the fantastical style employed is striking. In one of the pictures, an ape-man and his family are depicted moving through an area covered in trees. Despite their hairy bodies, the figures are portrayed as having a human posture and appearance, although this is nothing more than a work of imagination. *Scientific American* is employing a familiar tactic of evolutionist propaganda: filling the gaps left by lack of evidence with pictures.

The article claims that by studying the methods employed by living things to find and use energy we can understand how the evolutionary changes of natural selection came about. It then moves on to such elements of the imaginary evolutionist scenario as the transition to bipedalism, the increasing growth in the size of the brain, and *Homo erectus'* departure from Africa once he had completed his evolution.

What people need to be aware of is that, contrary to what is maintained in this article, natural selection has no evolutionary effect. This matter has already been explained in detail in the works of Harun Yahya, so we shall not repeat ourselves here. (See Harun Yahya, *The Evolution Deceit, Darwinism Refuted, The Collapse of the Theory of Evolution in 20 Questions*, at www.harunyahya.com)

The Claim That Nutrition Played an Evolutionary Role is Fictitious

The claim is put forward in the *Scientific American* article that "our ancestors" progress in increasing the energy obtained from food and raising its nutritional quality was one of the main features in mankind's evolution and splitting away from the other primates. Yet from the scientific point of view, this claim is totally without foundation. Better-nourished living things may have stronger bodies, and may be healthier and live longer. However, improved nutrition cannot cause them to turn into another species.

That is because there is no connection between nutrition and man's genetic make-up. In order for a "speciation event" to happen, the genetic structure needs to change to a considerable extent and to be redesigned. Such a thing has never, ever been observed in nature, and nutrition cannot affect genetic structure.

We can see this for ourselves: A cheetah community living in an



area where prey is plentiful, and which therefore has no need to compete with other predators, may grow stronger because it consumes more meat. Yet it is impossible for these cheetahs to evolve into lions. That is because cheetah DNA and lion DNA are different, and there is no relation between food intake and DNA structure. DNA base pairs are set out in strings in a particular sequence in all living species. That specific sequence gives rise to the living thing's genetic code, which is handed down unchanged from generation to generation. It is therefore impossible for nutrition to have played any role in mankind's so-called evolution. Claiming that nutrition can influence genetics and bring about "evolution" is no less of a superstition than Lamarck's thesis of "the inheritance of acquired traits."

The Transition to Bipedalism is an Imaginary Scenario

The article describes how apes' quadrupedal locomotion supposedly gradually changed into bipedal locomotion, and then considers the conditions that might have caused this so-called change. The best-known of the *Australopithecus* fossils that were put forward as the first species capable of upright walking were found in 1974 in a 40%-complete skeleton. This was the famous *Australopithecus afarensis* fossil, known as "Lucy." By looking at some of these bones, evolutionists claim that this species walked on two legs, for which reason it must have been the ancestor of man. The fact is, however, that much research into *Australopithecus* has revealed that it was a species of ape which did not walk in the same way as man at all:

1. Despite being a supporter of the theory of evolution, Lord Zuckerman arrived at the conclusion that *Australopithecus* was an ordinary species of ape, one that very definitely did not walk erect.¹

2. Another evolutionist anatomist, Charles E. Oxnard, well-known for his studies in this area, arrived at the conclusion that the *Australopithecus* skeleton resembles those of present-day orangutans.²

A DEFINITIVE REPLY
TO EVOLUTIONIST
PROPAGANDA



Another evolutionist assumption is that in some ape species brachiation (locomotion by hanging from branches with their arms and reaching from hold to hold) has preadapted these animals to bipedal walking. However, research has shown that the evolution of bipedalism never occurred, nor is it possible for it to have done so. Robin Crompton, senior lecturer in anatomy at Liverpool University, showed that a "compound" stride between quadrupedalism and bipedalism is not possible, because it would involve excessive energy consumption.

3. In 1994, Fred Spoor of Liverpool University and his team carried out a wide-ranging study to arrive at a definitive conclusion regarding the *Australopithecus* skeleton. The study was based upon an organ known as the "cochlea," which determines the position of the skeleton relative to the ground. Spoor's conclusion was that *Australopithecus*' mode of walking did not resemble that of man.³

4. In 2000, a study by the scientists B.G. Richmond and D.S. Strait published in the journal *Nature*, looked at *Australopithecus*' forearms. Comparative anatomical analyses showed that the species had just the same forearm anatomy as modern apes that walk on all four legs.⁴

These researches reveal that *Australopithecus*, which evolutionists put forward as an intermediate species, is actually an extinct species of ape.



Lucy, from Ethiopia, is the most complete skeleton of *Australopithecus* discovered so far. By looking at some of these bones unearthed, evolutionists claimed that *Australopithecus* walked on two legs, for which reason it must have been the ancestor of man. Based on this claim, they produced many drawings falsely presenting *Australopithecus* as an intermediate species between ape and man. The fact is, however, that much research into *Australopithecus* has revealed that it was a species of ape which did not walk in the same way as man at all.

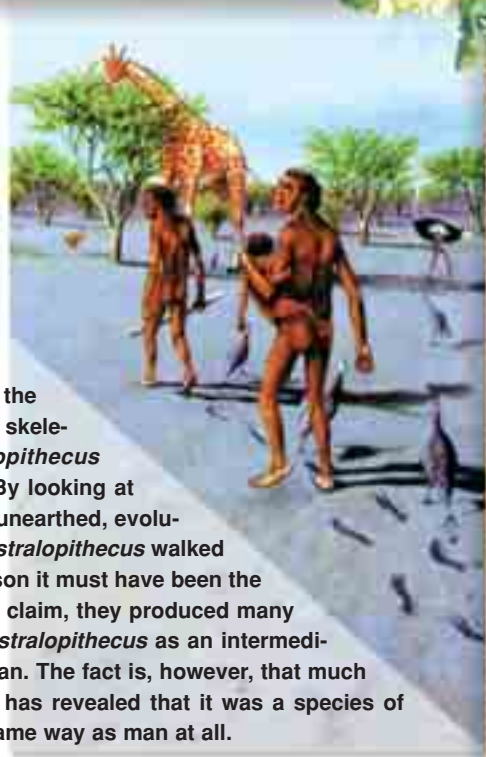

Chimpanzees Which Walk on Two Legs Invalidate the Evolutionists' Claims

As well as this research into *Australopithecus*, there is another discovery which has overturned the claim that walking on two legs was an evolutionary phase. Certain apes in our own time are capable of walking upright. According to a study by Dr. Robin Crompton of Liverpool University, published in *The Scotsman* under the title "Chimps on two legs run through Darwin's theory," chimpanzees living in the Bwindi region of Uganda also possess the ability to stand on two legs. The article states that this opposes the evolutionists' assumptions:

This means that the accepted idea of apes on the ground gradually evolving to an upright stance from a crouched position is wrong.⁵

Bipedalism and Other Humanoid Characteristics: A Morass of Prejudice and Speculation

Scientific American contains considerable speculation regarding the advantages that an adaptation such as walking on two legs might have brought with it. Yet, for some reason, this claim consists of speculation rather than hard evidence. The paleontologist Pat Shipman has this to say on the matter in a paper published in the journal *American Scientist*:

There is no shortage of ideas about the essential nature of the human species and the basic adaptations of our kind. Some say hominids are fundamentally thinkers; others favor tool-makers or talkers; still others argue that hunting, scavenging or bipedal walking made hominids special. Knowing what the First Hominid looked like would add some meat to a soup flavored with speculation and prejudice.⁶

A Deceptive Illustration

In one of the photographs published by *Scientific American*, skulls belonging to *Homo erectus* and the species *Australopithecus boisei* are compared. The anatomical differences between the two are then put down to nutritional habits.

The *Australopithecus boisei* skull shown on the left of the picture can clearly be seen to bear a close similarity to present-day chimpanzee skulls. The sagittal crest, which holds the former's powerful chewing muscles, and is alleged to have evolved from eating tough, fibrous plants, is also found in modern apes. The fossil shown as *Homo erectus* is actually human, and it is therefore natural that it should not possess a sagittal crest and a powerful jaw structure. What has been done here is to put two skulls, one ape and one human, side by side and then engage in pro-evolutionist speculation on the basis of the differences between them. Those who lack sufficient information in this area may well be taken in by these



A. boisei

H. erectus

claims made by evolutionists on the basis of no other authority than their academic positions and careers.

The fossil order and the scenarios regarding the transition to bipedalism that appeared in *Scientific American* are totally fictitious. Modern scientific discoveries are piling blow on blow on Darwinism. That is why scenarios regarding the evolution of man are no longer tenable. This article in *Scientific American* is nothing more than a new version, decorated with new illustrations, of the outdated claims designed to keep the theory of evolution on its feet.

1. Solly Zuckerman, *Beyond The Ivory Tower*, New York: Toplinger Publications, 1970, p. 75-94
2. Charles E. Oxnard, "The Place of Australopithecines in Human Evolution: Grounds for Doubt," *Nature*, vol. 258, p. 389
3. Fred Spoor, Bernard Wood, Frans Zonneveld, "Implication of Early Hominid Labryntine Morphology for Evolution of Human Bipedal Locomotion," *Nature*, vol. 369, June 23, 1994, pp. 645-648.
4. Richmond, B.G. and Strait, D.S., "Evidence that humans evolved from a knuckle-walking ancestor," *Nature* 404(6776): 382, 2000.
5. Richard Sadler, "Chimps on Two Legs Run Through Darwin's Theory," *The Scotsman*, September 13, 2002
6. "Hunting the First Hominid," Pat Shipman, *American Scientist*, January-February 2002, p. 25



**TIME WRITER M. LEMONICK'S
MIND-BODY ERROR**

Time magazine carried an article called "Your Mind, Your Body" in its February 17, 2003, edition. It was suggested that the Cartesian separation of mind and body no longer applies, and that psychologists and neurologists are now agreed that mind and body are interconnected. The claims in this article, written by Michael L. Lemonick, consist of nothing but deceptions. All Lemonick does is to set out his own materialist fantasies, though he is unable to offer a shred of scientific evidence to back them up.

Lemonick maintains that the thoughts and emotions that color our reality are the result of complicated electrochemical effects taking place within and among the nerve cells. As evidence for these claims, he suggests that the feelings of low self-esteem and self-hatred that appear in schizophrenia and depression have nothing to do with reality, but rather consist of faults in the electrochemical system in the brain.

Lemonick's interpretation, which makes the mind and body one, is nothing more than a dogmatic claim lacking any kind of scientific and rational foundation. Even today the materialists' mind-body problem has not been solved. In other words, the question of how consciousness (the state of a person's having knowledge of, understanding, thinking about, interpreting, and feeling his surroundings and himself) could have come about in a piece of flesh like the brain has not yet been resolved.

Materialist philosophers can never explain the source of human consciousness. In order not to accept the fact that there is a being beyond the material world, they attempt to reduce human intelligence to matter.

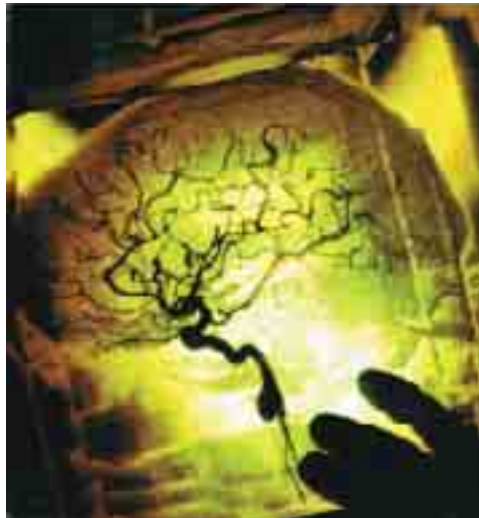

**A DEFINITIVE REPLY
TO EVOLUTIONIST
PROPAGANDA**

According to materialists, consciousness is the result of electrochemical reactions in the brain. In other words, consciousness comes about with the chemical and electrical exchanges between the cells that make up the tissue of the brain. The fact is, however, that there is no scientific foundation for this claim. Not even the most highly advanced MR brain scans have been able to establish where consciousness is located in the brain, nor which chain of brain functions comprise it. All the scientific research carried out throughout the twentieth century in order to explain the phenomenon of consciousness shows that consciousness has no material base.

Such a conclusion is inevitable. Matter has no ability or essence within itself that could give rise to consciousness. All

things considered, the brain cells that are believed to be the source of consciousness consist of nothing but

unconscious atoms. How is it that a grey,

damp piece of flesh made up of

such atoms is able to create the

very different characters of

billions of different peo-

ple? How do carbon,

oxygen, and hy-

drogen atoms

know how to arrange our bodies and emotions?

In fact, consciousness is an extraordinary property, and one that cannot be explained in terms of matter. Consciousness is literally a miracle.

Julian Huxley, an evolutionist who spent years trying to establish a materialist foundation for consciousness, admits his failure in these terms:

How it is that anything so remarkable as a state of consciousness comes about as a result of irritating nerve tissue, is just as unaccountable as the appearance of the Djinn, when Aladdin rubbed his lamp...¹

Of course brain damage can affect behavior. The chemicals people take can affect their characters. The symptoms of schizophrenia or depression can be observed in the brain. That is because the soul, the true origin of consciousness, extends to the material world via the brain. However, saying that the chemistry of the brain influences behavior and that psychological diseases can be observed in the brain, is not sufficient to resolve the mind-body problem. Colin McGinn, author of the book *The Problem of Consciousness*, makes the following confession on the subject:

We have been trying for a long time to solve the mind-body problem. It has stubbornly resisted our best efforts. The mystery persists. I think the time has come to admit candidly that we cannot solve the mystery.²

Conclusion

The claim made in *Time* magazine expresses nothing more than Lemonick's own personal and ideological fantasies. For Lemonick and other materialists, the mind-body problem is incapable of solution.

1. T. H. Huxley, *Lessons in Elementary Psychology*, p. 210

2. Colin McGinn, "Can We Solve the Mind-Body Problem?" *Mind*, 98 (1989), p. 349

**A DEFINITIVE REPLY
TO EVOLUTIONIST
PROPAGANDA**

*They said, "Glory be to You! We have no knowledge
except what You have taught us.
You are the All-Knowing, the All-Wise."
(Qur'an, 2:32)*