

# ENGINEERING IN NATURE

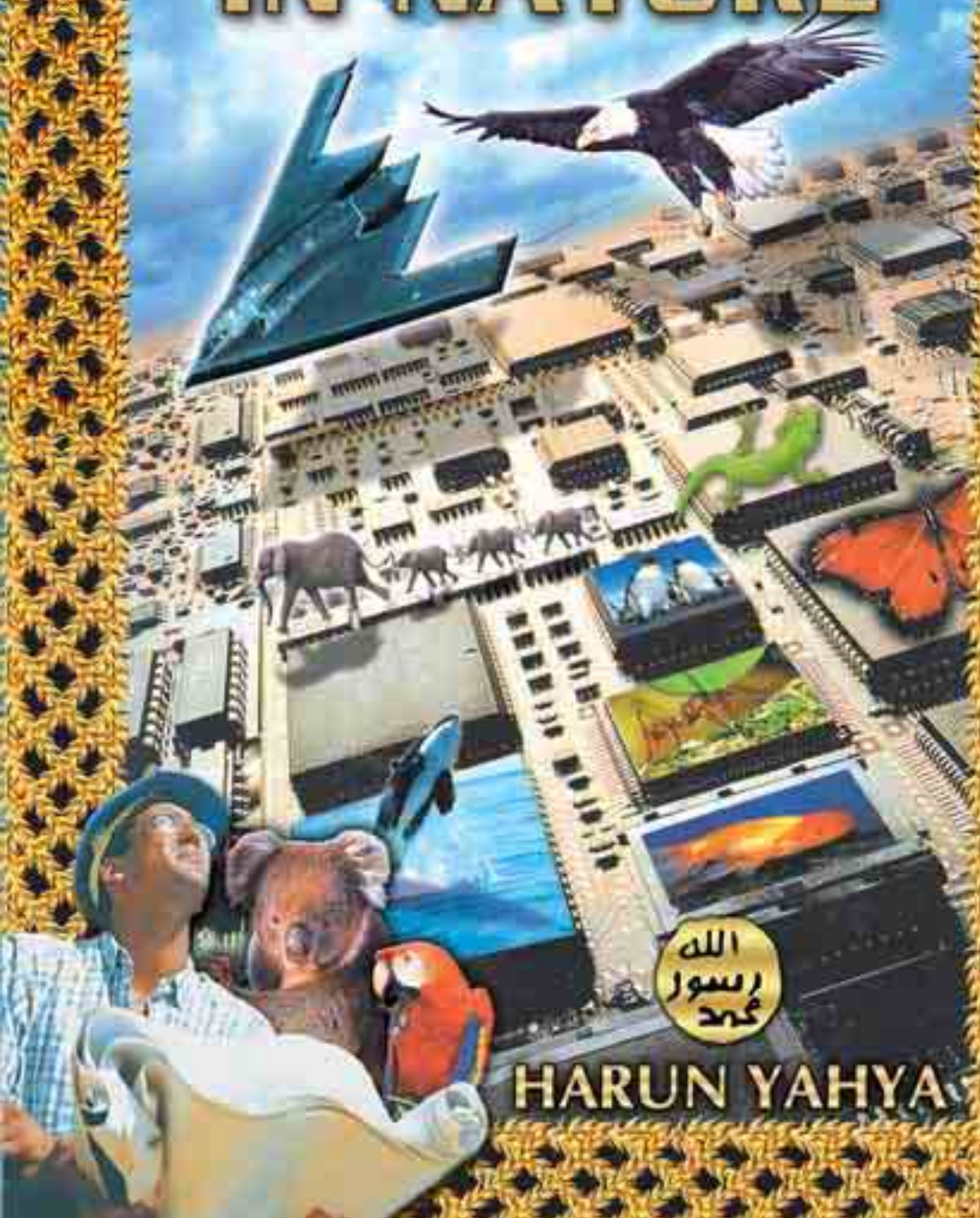

الله  
رسول  
محمد

HARUN YAHYA



A great many details we hardly think about are the products of engineering—designs and technology that have emerged after years of research, experience, and hard work by well-trained individuals.

For example, the refrigerator that keeps your food from spoiling was designed by engineers, as were your television, music set, elevator, watch, car and computer. All industrial machinery, satellites, spacecraft, and military technology are the products of engineering, representing the work and brainpower of a great many people.

Just like these designs that make our lives easier, there are countless designs in the bodies of living things that make their lives possible at all: perfectly functioning wings, cells that work like miniaturized chemical laboratories, infra-red-sensitive eyes that let their owners see in the dark, thick skin that can withstand heavy blows and harsh climactic conditions, and suckers that make it possible to walk on smooth surfaces— to name but a few.

When we compare such perfect designs in living things to the artificial designs that they often inspired, a striking parallel emerges: almost all the products of man's technology are no more than imitations of those in nature; and usually, they fail to match the superior design in living things, which are the work of Almighty God.



## About the Author

The author, who writes under the pen-name Harun Yahya, was born in Ankara in 1956. He studied arts at Istanbul's Mimar Sinan University, and philosophy at Istanbul University. Since the 1980s, the author has published many books on political, faith-related and scientific issues. Greatly appreciated all around the world, these works have been instrumental in helping many to return their faith in God, and, in many others, to

gain a deeper insight into their faith. Harun Yahya's books appeal to all kinds of readers, regardless of their age, race, or nationality, for they focus on one objective: to broaden the reader's perspective by encouraging him or her to think about a number of critical issues, such as the existence of God and His unity, and to live by the values He prescribed for them.

بِسْمِ اللَّهِ الرَّحْمَنِ الرَّحِيمِ

اللَّهُ  
رَسُولُهُ  
عَلَيْهِ



## To the Reader

A special chapter is assigned to the collapse of the theory of evolution because this theory constitutes the basis of all anti-spiritual philosophies. Since Darwinism rejects the fact of creation – and therefore, God's existence – over the last 140 years it has caused many people to abandon their faith or fall into doubt. It is therefore an imperative service, a very important duty to show everyone that this theory is a deception. Since some readers may find the chance to read only one of our books, we think it appropriate to devote a chapter to summarize this subject.

All the author's books explain faith-related issues in light of Qur'anic verses, and invite readers to learn God's words and to live by them. All the subjects concerning God's verses are explained so as to leave no doubt or room for questions in the reader's mind. The books' sincere, plain, and fluent style ensures that everyone of every age and from every social group can easily understand them. Thanks to their effective, lucid narrative, they can be read at one sitting. Even those who rigorously reject spirituality are influenced by the facts these books document and cannot refute the truthfulness of their contents.

This and all the other books by the author can be read individually, or discussed in a group. Readers eager to profit from the books will find discussion very useful, letting them relate their reflections and experiences to one another.

In addition, it will be a great service to Islam to contribute to the publication and reading of these books, written solely for the pleasure of God. The author's books are all extremely convincing. For this reason, to communicate true religion to others, one of the most effective methods is encouraging them to read these books.

We hope the reader will look through the reviews of his other books at the back of this book. His rich source material on faith-related issues is very useful, and a pleasure to read.

In these books, unlike some other books, you will not find the author's personal views, explanations based on dubious sources, styles that are unobservant of the respect and reverence due to sacred subjects, nor hopeless, pessimistic arguments that create doubts in the mind and deviations in the heart.



# **ENGINEERING IN NATURE**

**Harun Yahya**



## About the Author

Now writing under the pen-name of HARUN YAHYA, he was born in Ankara in 1956. Having completed his primary and secondary education in Ankara, he studied arts at Istanbul's Mimar Sinan University and philosophy at Istanbul University. Since the 1980s, he has published many books on political, scientific, and faith-related issues. Harun Yahya is well-known as the author of important works disclosing the imposture of evolutionists, their invalid claims, and the dark liaisons between Darwinism and such bloody ideologies as fascism and communism.

Harun Yahya's works, translated into 57 different languages, constitute a collection for a total of more than 45,000 pages with 30,000 illustrations.

His pen-name is a composite of the names Harun (Aaron) and Yahya (John), in memory of the two esteemed prophets who fought against their peoples' lack of faith. The Prophet's (may God bless him and grant him peace) seal on his books' covers is symbolic and is linked to their contents. It represents the Qur'an (the Final Scripture) and Prophet Muhammad (may God bless him and grant him peace), last of the prophets. Under the guidance of the Qur'an and the Sunnah (teachings of the Prophet), the author makes it his purpose to disprove each fundamental tenet of irreligious ideologies and to have the "last word," so as to completely silence the objections raised against religion. He uses the seal of the final Prophet (may God bless him and grant him peace), who attained ultimate wisdom and moral perfection, as a sign of his intention to offer the last word.

All of Harun Yahya's works share one single goal: to convey the Qur'an's message, encourage readers to consider basic faith-related issues such as God's existence and unity and the Hereafter; and to expose irreligious systems' feeble foundations and perverted ideologies.

Harun Yahya enjoys a wide readership in many countries, from India to America, England to Indonesia, Poland to Bosnia, Spain to Brazil, Malaysia to Italy, France to Bulgaria and Russia. Some of his books are available in English, French, German, Spanish, Italian, Portuguese, Urdu, Arabic, Albanian, Chinese, Swahili, Hausa, Dhivehi (spoken in Mauritius), Russian, Serbo-Croat (Bosnian), Polish, Malay, Uygur Turkish, Indo-

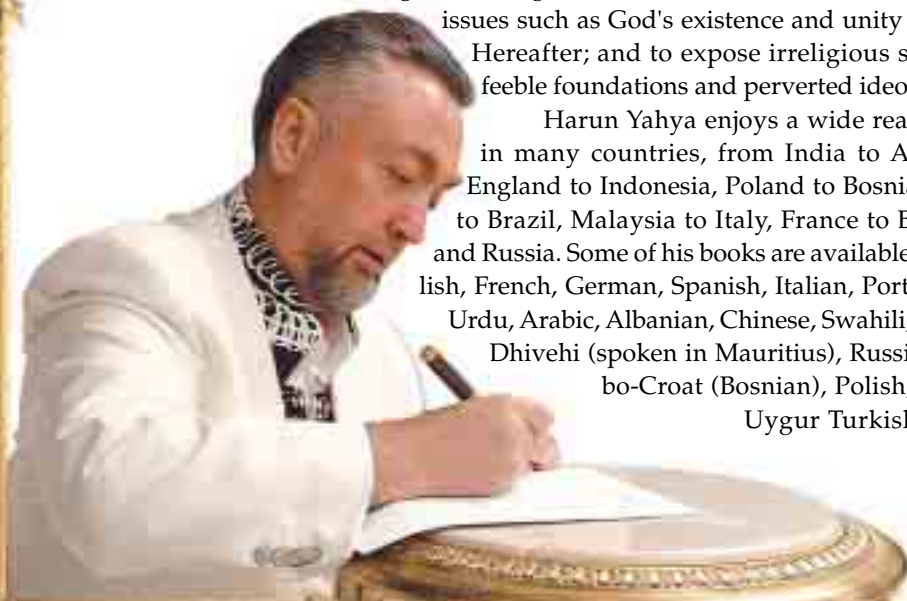

nesian, Bengali, Danish and Swedish.

Greatly appreciated all around the world, these works have been instrumental in many people recovering faith in God and gaining deeper insights into their faith. His books' wisdom and sincerity, together with a distinct style that's easy to understand, directly affect anyone who reads them. Those who seriously consider these books, can no longer advocate atheism or any other perverted ideology or materialistic philosophy, since these books are characterized by rapid effectiveness, definite results, and irrefutability. Even if they continue to do so, it will be only a sentimental insistence, since these books refute such ideologies from their very foundations. All contemporary movements of denial are now ideologically defeated, thanks to the books written by Harun Yahya.

This is no doubt a result of the Qur'an's wisdom and lucidity. The author modestly intends to serve as a means in humanity's search for God's right path. No material gain is sought in the publication of these works.

Those who encourage others to read these books, to open their minds and hearts and guide them to become more devoted servants of God, render an invaluable service.

Meanwhile, it would only be a waste of time and energy to propagate other books that create confusion in people's minds, lead them into ideological chaos, and that clearly have no strong and precise effects in removing the doubts in people's hearts, as also verified from previous experience. It is impossible for books devised to emphasize the author's literary power rather than the noble goal of saving people from loss of faith, to have such a great effect. Those who doubt this can readily see that the sole aim of Harun Yahya's books is to overcome disbelief and to disseminate the Qur'an's moral values. The success and impact of this service are manifested in the readers' conviction.

One point should be kept in mind: The main reason for the continuing cruelty, conflict, and other ordeals endured by the vast majority of people is the ideological prevalence of disbelief. This can be ended only with the ideological defeat of disbelief and by conveying the wonders of creation and Qur'anic morality so that people can live by it. Considering the state of the world today, leading into a downward spiral of violence, corruption and conflict, clearly this service must be provided speedily and effectively, or it may be too late.

In this effort, the books of Harun Yahya assume a leading role. By the will of God, these books will be a means through which people in the twenty-first century will attain the peace, justice, and happiness promised in the Qur'an.









**ENGINEERING  
IN NATURE**

**Harun Yahya**

Translated by Carl Rossini  
Edited by Tam Mossman

Published by  
**GLOBAL PUBLISHING**  
Talatpasa Mahallesi, Emirgazi Caddesi,  
İbrahim Elmas İş Merkezi A Blok, Kat: 4  
Okmeydanı - İstanbul / Turkey  
Tel: +90 212 222 00 88

Printed and bound by Secil Ofset in İstanbul  
100 Yıl Mah. MAS-SIT Matbaacılar Sitesi 4. Cadde No: 77  
Bağcılar-İstanbul/Turkey  
Phone: (+90 212) 629 06 15

All translations from the Qur'an are from *The Noble Qur'an: a New Rendering of its Meaning in English* by Hajj Abdalhaqq and Aisha Bewley, published by Bookwork, Norwich, UK. 1420 CE/1999 AH.

[www.harunyahya.com](http://www.harunyahya.com) - [www.harunyahya.net](http://www.harunyahya.net)







# CONTENTS

<i>Introduction</i> .....	10
<i>Living Things in Competition with Chemical Engineers</i> .....	16
<i>Perception Systems in Animals</i> .....	56
<i>Physical Engineers with Advanced Knowledge of Optics</i> .....	102
<i>Mechanical Experts in Nature</i> .....	114
<i>Undersea Engineers</i> .....	160
<i>Conclusion</i> .....	178
<i>The Deception of Evolution</i> .....	182







**Introduction**





he field of engineering is divided into many different branches, but its main objective is to make our daily lives more comfortable, easier and safer. A great many details we hardly think about are the products of engineering—designs and technology that have emerged after years of research, experience, and hard work by well-trained individuals.

For example, the refrigerator that keeps your food from spoiling was designed by engineers, as were your television, music set, elevator, watch, car and computer. All industrial machinery, satellites, spacecraft, and military technology are the product of engineering, representing the work and brainpower of a great many people.

Just like these designs that make our lives easier, there are countless designs in the bodies of living things that make their lives possible at all: perfectly functioning wings, cells that work like miniaturized chemical laboratories, infra-red-sensitive eyes that let their owners see in the dark, thick skin that can withstand heavy blows and harsh climatic conditions, and suckers that make it possible to walk on smooth surfaces— to name but a few.

When we compare such perfect designs in living things to the artificial designs that they often inspired, a striking parallel emerges: almost all the products of man's technology are no more than imitations of those in nature; and usually, they fail to match the superior design in living things.

Throughout this book, we shall be examining just a few of the proofs of this evident truth.

Adnan Oktar

## The Incomparable Design in Living Things

Scientists have carried out various studies on how owls are able to approach their prey so silently in the still of night without making themselves heard. Research carried out under the U.S. Air Force's "Ghost Plane Project" revealed these birds' faultless wing design.

The feathers of other bird species have sharp edges, while owls' feathers do not. This enables the animal to fly and hunt at night, completely silently.

According to a statement by scientists at NASA's Langley Research Center, the soft edges of an owl's feathers prevent air turbulence, that in turn prevents noise. When looking for ways of making ghost planes fly through the sky without being detected, military designers copied the owl feather's structure.<sup>1</sup>

At the world's busiest airports, planes land and take off roughly every two to three minutes during the day. Airway traffic of this density is controlled by leaving between planes a distance of 4 to 5 km (2



*"Ghost" planes invisible to modern radar have been manufactured, but the noise from all low-flying planes can be heard from hundreds of meters away. Scientists are trying to solve this problem by studying the silent flight of owls and adapting their wings' designs.*



to 3 miles). This minimum security distance needed is determined by such considerations as the size of the plane and its maneuverability.<sup>2</sup>

Yet birds fly in huge flocks, with a far greater density than that of airplanes in formation. How do hundreds of creatures fly with such control and safety at the same time?

Consider the plover, which lives in coastal areas. The "safety gap" for this species is only a few lengths, yet the birds fly at more than 30-40 km (18-25 miles) per hour. Despite that speed, however, they are able to take off and land with ease.

This superior flying ability requires a special engineering calculation, which aircrafts have not yet been able to achieve. Long years of research have produced some high-maneuverability planes, such as helicopters that can hang suspended in the air and land and take off vertically. Yet these machines' flying abilities and maneuverability come nowhere near to those exhibited by living things.

The structures in the bodies of living things are far superior to those we humans have designed. This perfection can be clearly seen



when we consider just the example of wings. How did these incomparable designs come about? Why is it that the owl has silent wings that lets it hunt at night, and not the noisy wings of a pigeon or a swan? How does the pit viper locate its prey at night by using its infrared sensor? Who placed all these complex systems—which our human engineers now strive to duplicate—in the bodies of living things?

Evolutionists answer such questions by supposing that living things acquired their present characteristics through accidental genetic changes in their bodies over time, in other words, by "gradual change." Yet this claim is meaningless when considered in the light of logic and reason, as well as the scientific facts. It is impossible for cells to have come about by chance and then, of their own accord, to have combined to form such flawless structures. This is just as irrational and illogical as claiming that giant skyscrapers or bridges came into being by accident.

It's impossible for even one of the billions of cells that comprise the bodies of living things to have arisen by chance. The cell's structure is so complex that it cannot be reproduced even with today's technology. All attempts to create an artificial cell have ended in failure. Countless similar examples of design in nature reveal the evident truth that God, the Lord of infinite might and knowledge, designed all living things right down to their tiniest details, in an incomparably perfect manner. Evolutionists find themselves in a position that needs to be weighed more carefully.

The presence of perfect technologies in the bodies of a tiny insect, fish, or bird, far superior to those planned by man, reveals proof that they were created. These unique designs in nature are the work of Almighty God, Who in one verse reveals:



Say: "Who is the Lord of the heavens and the Earth?" Say: "God."  
Say: "So why have you taken protectors apart from Him who possess no power to help or harm themselves?" Say: "Are the blind and seeing equal? Or are darkness and light the same? Or have they assigned partners to God who create as He creates, so that all creating seems the same to them?" Say: "God is the Creator of everything. He is the One, the All-Conquering."  
(Surat ar-Ra'd: 16)

This book's purpose is to let the reader grasp the infinite might of God by revealing once again, from a different perspective, the perfect designs that have existed in nature, unchanged for billions of years.

### **Intelligent Design, in other words Creation In order to create, God has no need to design**

It's important that the word "design" be properly understood. That God has created a flawless design does not mean that He first made a plan and then followed it. God, the Lord of the Earth and the heavens, needs no "designs" in order to create. God is exalted above all such deficiencies. His planning and creation take place at the same instant.

Whenever God wills a thing to come about, it is enough for Him just to say, "Be!"

As verses of the Qur'an tell us:

**His command when He desires a thing is just to say to it, "Be!" and it is. (Surah Ya Sin: 82)**

**[God is] the Originator of the heavens and Earth. When He decides on something, He just says to it, "Be!" and it is. (Surat al-Baqara: 117)**

*Chapter One*

# Living Things in Competition with Chemical Engineers

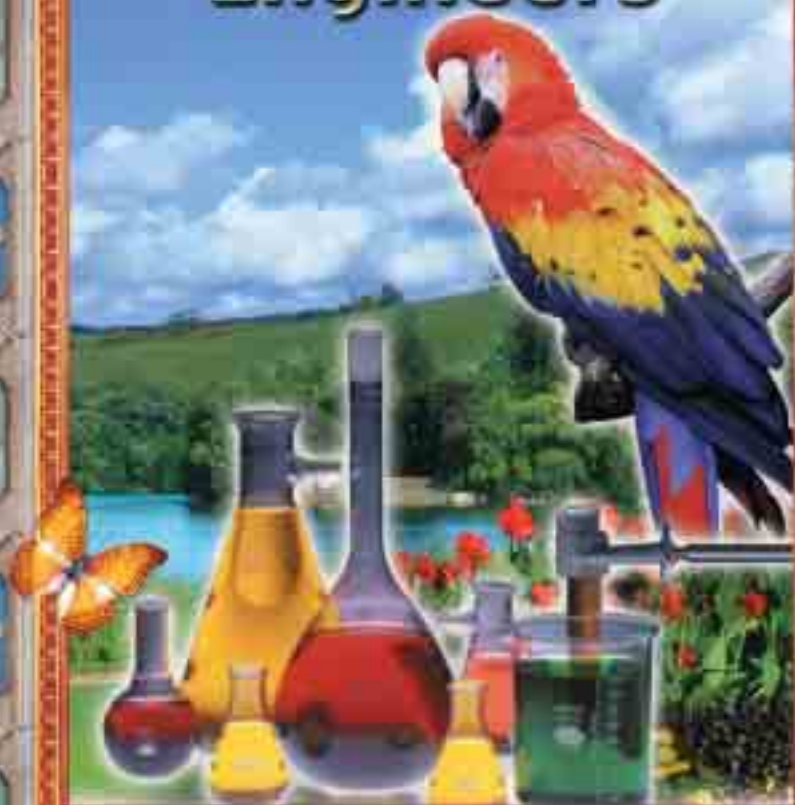





When you want information about medicines, you go to a pharmacist who has been trained in that field. He will have considerable professional experience, know all about what various medicines contain, their purposes and side effects. Yet not even an expert on chemical compounds can tell what beneficial substances a plant may contain, by simply looking at it. How, for example, can anyone look at a foxglove and say "There is a substance in this, digitalis, that can be used as an antidote to the heart problems"? One must either ask others who possess the requisite knowledge and experience, or else one must carry out research and experiments by oneself.

Mere guessing could be exceedingly dangerous. For example, anyone bitten by a poisonous snake needs to be treated at once. In such serious situations, when a moment's delay may result in death, one clearly, cannot resort to guesswork or trial and error.

Humans cannot carry out this difficult procedure without conducting experiments, but a great many living things have been doing this "naturally" for millions of years. For example, the Bezoar goats—which we'll examine in greater detail later on—can neutralize snake venom. For a creature devoid of reason to know instantly what substance a plant contains, to correctly decide what purpose it serves, to know under what

Engineering in Nature



circumstances it should be used —and, furthermore, for all members of the species to share that knowledge— proves one single truth:

There is a power which governs that creature, inspires the necessary knowledge in it, and rules its behavior. This power belongs to Almighty God.

**THE CHEMICAL KNOWLEDGE OF BEZOAR GOATS**

The Bezoar goat can climb up sheer rock faces. The bottoms of its



hooves are rough, and the soft pads under its feet let it move with great agility. The name *Bezoar* actually stems from a Farsi word meaning *medicine*, and these goats are experts at treating themselves—thanks to this species' astonishing knowledge of chemistry.

When a Bezoar goat is bitten by a snake, immediately it begins eating one of the species of *Euphorbia* which grow around.

This is a most astonishing behavior, because these plants contain euphorbon, a substance that neutralizes the venom in the goat's blood system.<sup>3</sup>

What allows these goats, who do not even touch *Euphorbia* in their day-to-day grazing, to use these plants as a medicinal treatment? How do they know that they need this plant because the chemicals in the plant are an effective antidote against snake venom?

It's impossible for them to find the one plant effective against snake venom by trial and error. A goat starting to test all the hundreds of kinds of plants growing around will have no time to try more than a few. Even if it is successful once, the goat will still have to make the same correct decision in the future, every time it is bitten. For the moment, let's assume that a single goat does manage to do this. Yet all its members need to display this behavior in order for the entire species not to become extinct.

Therefore, the first successful goat has to pass on its experience to others. But it is not possible for a living thing to pass on the acquired traits to succeeding generations. To use an analogy; imagine someone who graduates from university with honors. None of the knowledge he's gained or efforts he's put in will be of any use to his children or grandchildren. Any knowledge or behavior that the individual acquires will die with that individual. It's not possible for "know-how"

to be injected into the genes of a living thing so that it may pass on its experience to subsequent generations. Every generation has to re-acquire the same information, directly right from scratch.

Deep consideration of examples like these is enough to show that living things' behavior cannot come about by chance. Through being inspired and taught by God, living things acquire all the knowledge they need. God leaves no living thing unguided and at the mercy of so-called chance. In one verse of the Qur'an, God reveals that He has complete control of and dominion over living things:

**I have put my trust in God, my Lord and your Lord. There is no creature He does not hold by the forelock. My Lord is on a straight path. (Surah Hud: 56)**





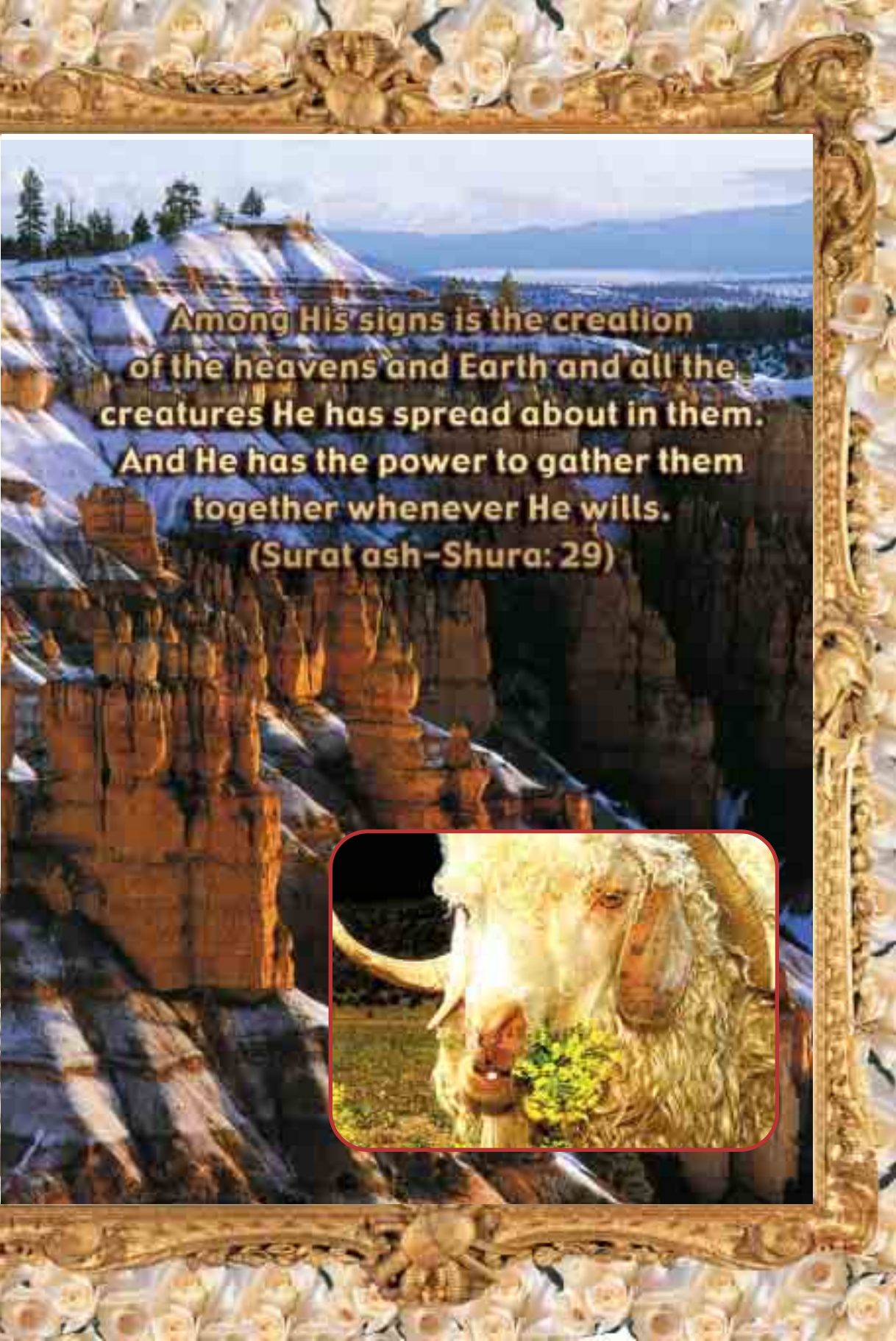

**Among His signs is the creation  
of the heavens and Earth and all the  
creatures He has spread about in them.  
And He has the power to gather them  
together whenever He wills.  
(Surat ash-Shura: 29)**



## CAN ANTS BUILD AN ACID FACTORY?

Glands in ants' bodies produce formic acid ( $\text{H}_2\text{CO}_2$ )<sup>4</sup> Ants regularly spread this chemical substance, with its antibiotic properties, over their bodies, thus preventing bacteria and fungi from growing on themselves and in their nest.

That ants secrete this "disinfectant" acid in their own bodies and know how to use it is astonishing. Even more amazing, however, is that other creatures are also aware of their ability.

Some species of bird also use this acid in ants. Though unable to secrete chemical substances themselves, they frequently visit anthills and let the ants crawl among their feathers, leaving behind the formic acid they produce—and thus ridding themselves of all their parasites.

How does the ant know that formic acid is effective against fungi—let alone the chemical formula for that acid? How is it that the ant comes to no harm, while producing such a dangerous acid in its body? Moreover, how do birds know that they can use ants' formic acid to get rid of parasites?

First, we need to question how this chemical substance

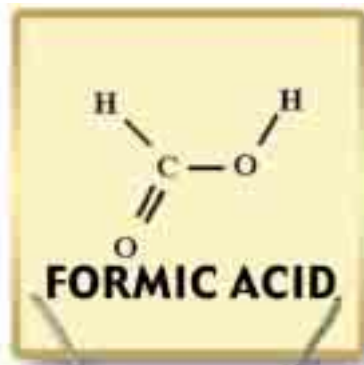



came into being. It is totally impossible for any chemical substance that serves a specific purpose to arise by chance. Any error in the synthesis of formic acid will mean that it loses its antibiotic properties, and run the risk of harmful, poisonous substances being created.

That being so, it's most illogical to maintain that the ant synthesized this substance on its own, or that the ant's body produces it by chance. Leaving that aside, let's assume that formic acid's formula emerged fully and complete. But this still changes nothing, because there must be not only a system to produce the acid in the ant's body, but also some system to protect the ant and keep the acid from doing it any harm. This clearly reveals that, contrary to what evolutionists would have us believe, the ant's glands could not have developed in stages.

None of these creatures can carry out these procedures on their own. The fact is that ants emerged suddenly, together with all their characteristics. God, the Omniscient, created formic acid, the glands to produce it, at the same time He created ants themselves.

It is also God Who inspires birds to visit ants' nests to make use of their formic acid. God knows the needs of all living things and creates the means with which they can be met. In one verse, it is revealed that God surrounds and pervades all:

**It is God Who created the seven heavens and of the Earth the same number, the Command descending down through all of them, so that you might know that God has power over all things and that God encompasses all things in His knowledge. (Surat at-Talaq: 12)**

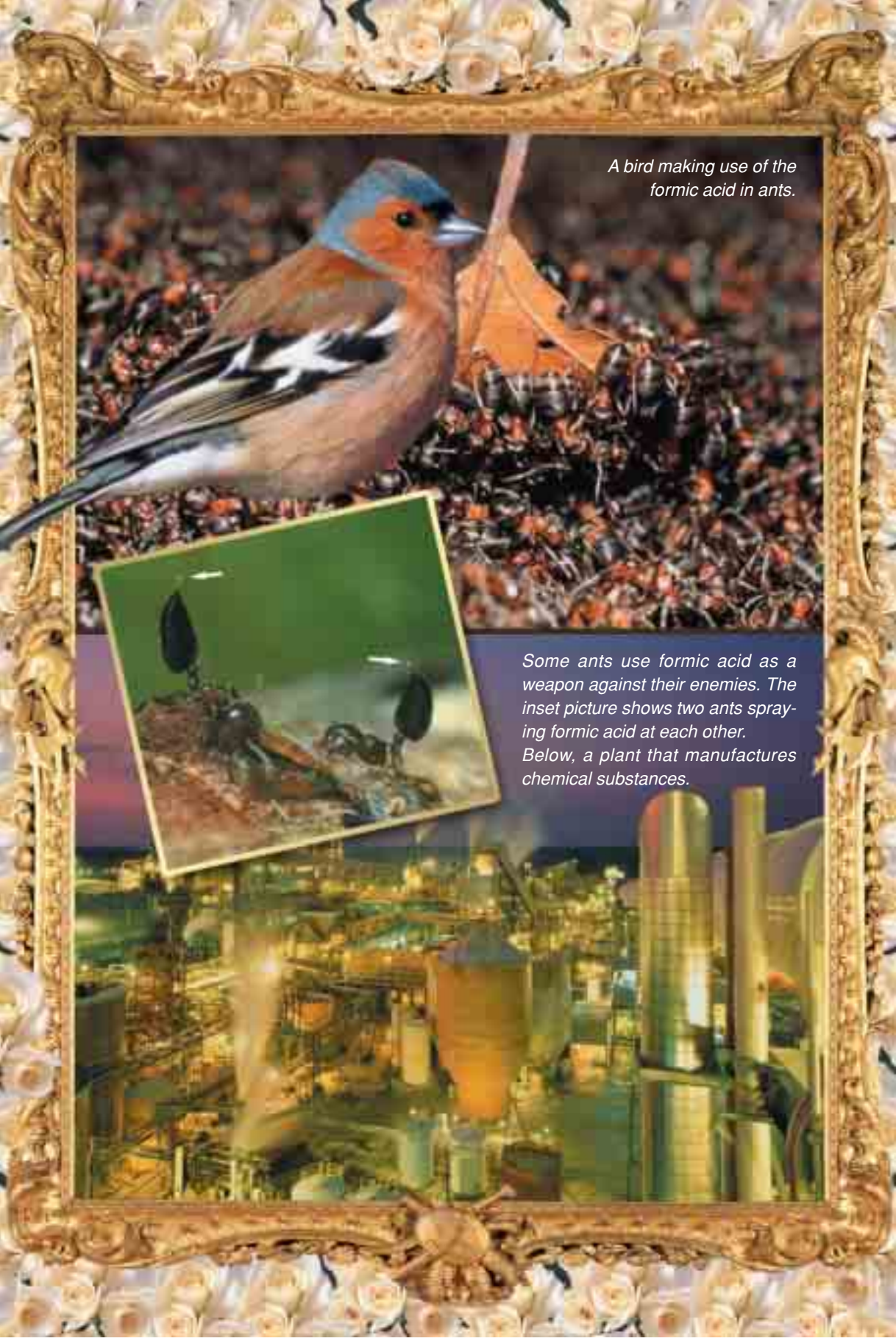

*A bird making use of the formic acid in ants.*

*Some ants use formic acid as a weapon against their enemies. The inset picture shows two ants spraying formic acid at each other. Below, a plant that manufactures chemical substances.*



## **CHEMICAL COMMUNICATION AMONG INSECTS: PHEROMONES**

Even if they travel great distances away, ants never fail to find their way back to their nests, nor bees the way to their hives. When danger threatens some insect larvae, they immediately come together for protection. At mating time, male and female insects of all species can easily find each other, even at considerable distances. These forms of behavior all take place thanks to communication between individuals.

To communicate, many creatures use signals of one kind or another. The ones used by insects are known as *pheromones*, chemical substances used among members of the same species. They are generally produced in special glands and emitted into the surrounding area, causing changes in insect behavior.

The word itself means "hormone bearers." Indeed, pheromones were once regarded as the equivalent of hormones. Like hormones, they are emitted in small quantities (albeit outside the body) and are responsible for performing a vital function. Pheromones are generally unique to a particular species. There are also some that perform very different functions and in different combinations. Pheromones have a high level of dispersal, and can have an effect from a distance as much as 7-8 km (4-5 miles), with such factors as distance, heat, wind and humidity reducing or increasing their effects.

Pheromones are used for such purposes as sign-leaving, sounding an alarm, gathering members together, for the raising of queens among communal insects, or to control the development of sexual maturity. There are also sex pheromones that work by means of scent.

## Engineering in Nature

When reading about animals that communicate through pheromones, one very important point needs to be kept in mind: Every species has its own individual formula, and the chemical substances each contains are all different. The creature that emits the "communicating" substance and the one that receives the "message" are both aware of this formula. Moreover, as you'll see in the following pages, some creatures also decipher and imitate the formulas belonging to other species.

*Smell whatever perfume you use, then deduce what substances it contains. Then try and produce every one of these substances and make a perfume with the exact same smell, of the exact same quality. Unless you have special training in this area, or receive help from experts in the field, you'll of course be unable to do so. The insects that use pheromones to communicate may manufacture them, because God inspires them to do so.*







- **Communication by Pheromones**

Pheromone communication is most generally found among animals that live communally, such as bees, ants and termites. The chemical traces may be left wherever the insects move—on trees, branches, leaves and fruit. Flying insects deposit traces in the air that need to be constantly renewed. Sex pheromones that work by means of scent form part of this group.

Thanks to insects' small sizes and their ability to fly and move quickly, they are able to move over wide areas—which at first sight might pose an obstacle to mating. This is resolved, however, by pheromones.

Sex pheromones allow male and female insects to find one another by means of scent. For example, in one butterfly species of the Lymantriidae family, the male's powerful antennae detect the attractive scent given off by the rearmost part of the female's body. The male can detect this scent from as far away as 8 km (5 miles), and any other smell cannot mask or suppress it. Attracted by the female's scent alone, the male finds her, and mating then takes place.<sup>5</sup>

Another striking example of communication through pheromones is found among cherry fruit flies (*Rhagoletis cerasi*). After laying its eggs on the fruit of the cherry tree, the female fly protects them by depositing on the fruit a pheromone secreted by its body. Other female

Engineering in Nature



*Ants use pheromones for communication. The first individual to leave the nest deposits the scent at specific intervals. Later ants that follow are easily able to follow that trail. The detection of the chemical trail left by one member happens by means of the sense of taste or smell.*



flies detect the pheromone, receive the message, and immediately fly off in search of another cherry tree in which to lay their eggs.<sup>6</sup>

Without pheromones, it would be impossible for bagworm moths to survive. The larval stage of this species makes a kind of camouflage bag to protect itself from predators. In making its sac, the larva uses such materials as leaves and twigs from whatever plant it lives on. Bagworm moths never leave their sacs, not even when feeding. When the females pupate and reach adulthood, they still cannot leave, since they have neither wings nor legs.

Mating also takes place inside this cocoon, thanks to a special pheromone the female gives off. When ready to mate, she emits a chemical substance that softens and loosens her cocoon, to facilitate the male moth's entry. Detecting the pheromone given off by the female, he opens a small hole in the softened cocoon and mates with the female he has never seen. The female then lays her eggs inside the cocoon. To close up the opening made by the male, she produces another substance in her body, and dies shortly thereafter. When her



*Bagworm moth and its bag*



**Barred Sulphur butterfly**

caterpillars hatch, they tear apart the sac and continue their development by spinning new ones.<sup>7</sup>

These creatures enjoy complete success in what they do. They can detect and immediately recognize the scent of their own species, even from several kilometers away. Even with modern technology, it is impossible for any human being or machine to detect a scent from that distance. Nevertheless, insects only 1 to 2 cm (0.4 to 0.8 inch) long can use special receptors in their bodies to detect smells. God has created these animals with their perfect systems. God, Who creates incomparably, is all-powerful.

The Barred Sulphur butterfly, with striking patterns on its wings, is one of the most common species in Florida. Through the edges of the top part of the males' front wings passes a black line that is absent in females. The male has scent scales in this black line, which exude a special perfume to attract the females to where he is.<sup>8</sup>

On the head of the male lo moth are hair-like sensors, the source of the moth's perfect scent recognition ability that lets it locate a mate from up to 1.5 kilometers (1 mile) away.<sup>9</sup>

• **The General Characteristics of Pheromones**

In some insect species, sex hormones are released at specific times of day. For instance, *Sporganothis pilleriana* butterflies always release their sex pheromones between 11:00 AM and 4:00 PM. The female honeybee, *Apis mellifera*, releases her sex pheromone throughout the course of her life. After she mates, this pheromone prevents the bees



from raising a new queen, which would otherwise lead to chaos in the hive.

Among insects that live communally, pheromones also assist with food distribution and also the defense of the colony. These pheromones let colony members recognize each other and refuse admittance to strangers who lack that distinctive scent.

For example, sweet bees of the species *Halictidae* maintain the cohesion of the colony thanks to their own unique pheromone. The bees cover the earthen part of the entrance to their nest and the main nest's upper sections with a special secretion. This consists of a chemical compound known as macrocyclic lactone. Every member of the colony has its own lactone mixture, giving it a kind of chemical fingerprint.

The colony's worker bees leave their own secretions at the entrance to the nest and in the upper tunnel regions. The lactone mixtures of all the colony members mingle together, thus giving the entrance a unique smell. This is important because in regions where these bees live, hundreds of nests are found very close to one another. This scent at the nest's entrance lets returning workers recognize their



own abode out of hundreds. Moreover, this scent allows sentry bees guarding the hive's entrance to recognize their fellows. As we have seen, these tiny bees have a capacity for scent recognition and distinction far beyond that of any human nose.<sup>10</sup>

• **Imitation Pheromones**

Startlingly, some living things are able to imitate the pheromones used by others! For instance, some plants make use of insects' sensitivity to pheromones and produce similar substances to deceive them.

In addition, pheromones ensure the continuation of species. The wings of Central America's "Florida Queen" butterfly bear a close resemblance in color and design to those of another species. Sometimes these two species are deceived by each others' colors when looking for mates, but males recognize females of their own species by their scents. In order to make it easier for males to detect her pheromone, the female uses her wings like a fan, wafting her scent towards a likely mate. The survival of the species is thus guaranteed.<sup>11</sup>





Harun Yahya



*The male Polyphemus moth has wide, hairy antennae so sensitive that it can detect the scent of a female moth from several kilometers away. Indeed, even if the female only emits 1 millionth of a gram an hour, males still have no difficulty in detecting it. The moth's scent detection sense is so effective thanks to the presence of some 17,000 tiny hairs on each antenna. Each tiny hair, in turn, has thousands of scent-detecting pores, raising the moths' sensitivity to exceedingly high levels.*

*How did the moths come by this flawless scent-detecting ability?*

*How did this structure in the tiny moth's body, with its 17,000 hairs and the thousands of pores on each hair, come into being?*

*It is impossible for an insect to have produced such a highly developed system by chance. Anyone will immediately see the illogical nature of such a claim. God created the moths together with their matchless characteristics.*

Adnan Oktar

**Some pheromone formulas**

Engineering in Nature





Harun Yahya

*Many insects use chemical substances known as pheromones in order to communicate. Every insect recognizes the pheromone of its own species and acts on the message communicated by it. However, insects have no laboratory, and none receives training in chemical engineering. Yet still they know the meaning of these secretions, because Almighty God has created them together with the systems necessary for analyzing these pheromones.*

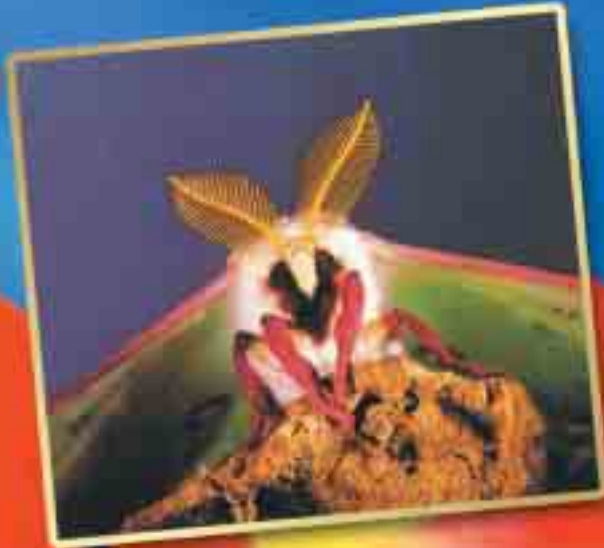

Adnan Oktar

• **When Gathering Time Comes**

Insects give off "gathering" pheromones when they rest, and all the individual members of the species come together. These pheromones allow insects such as bees, ants and termites to live together.

Among shelled insects of species *Ipidae* and *Scolytidae*, individuals fortunate enough to find a tree trunk suited to feeding and egg-laying secrete off a pheromone, causing all the members of the colony to gather together.<sup>12</sup>

Fire ants drag their stings along behind them, leaving a scent trail for the members of the colony to follow. J. H. Tumlinson, at the U.S. Department of Agriculture's Research Service Laboratories in Gainesville, Florida, estimated that 1 milligram of this substance could lead a column of ants around the world three times!<sup>13</sup>

Considering this precise effect that pheromones have, one can immediately see just how important they are for insects. Particularly in times of danger, the slightest defect in this communications system could have devastating consequences. The pheromones given off at such times sound the alarm through the entire colony.

Alarm pheromones, which evaporate and have short-lived effects, are the same in many species. When danger approaches, ants emit pheromones from glands in the hind parts of their bodies, bees from glands in their stings, and other insects from glands in their mouth parts. Ants emit the alarm pheromone in order to muster together for attack purposes. The pheromone's scent brings the members of the colony together and allows many individuals to take part in a united defense.

For example, when some species of leaf mite are attacked by larger insects, they give off an alarm pheromone that warns other individuals feeding nearby to move away. Leaf mites detect these chemical se-



cretions through special sensors on their antennae.

When termites discover a split in the mound they've constructed, they emit a scent that sounds the alarm and calls other termites to repair the fissure and defend the nest against attack.

The striking common feature in all this is that these living things all recognize the chemical formulae of their species' own pheromones and act in accordance with the commands issued by them. How can an insect manage to distinguish between chemical substances and decode them? First, they need to know—or in other words, analyze—what the secretion contains. To perform that analysis, they need a well-equipped laboratory, as well as the requisite knowledge, of course. Insects have neither advanced laboratories nor any other technical equipment, yet still they carry out successful analyses and fully understand and adhere to the messages the pheromones convey.

A human being would need training and considerable experience as a chemical engineer in order to do this. Insects need neither training nor experience to understand what their secretions mean, since they possess this knowledge from birth. They never confuse their species' own secretions of with those of others (except from those taken in by imitations), because Almighty God has created them together with the system necessary to identify that certain pheromone.

In the Qur'an, God draws attention to what He has created in the heavens and on the Earth, and reveals:

**How many signs there are in the heavens and Earth! Yet they pass them by, turning away from them. Most of them do not believe in God without associating others with Him. (Surah Yusuf: 105-106)**

## **AN IMPORTANT SOURCE: DIATOMS**

Diatoms are microscopic plant algae. Up to 10,000 of these living things, the largest of which is only 1 mm in diameter, can be found in 1 cubic centimeter of sea water. Not all diatoms live in water, however. Some live in soil, on the moss clinging to trees, and even on walls where there is sufficient moisture. These golden yellowy-brown algae can be found wherever there is light, heat, water, carbon dioxide and sufficient nutriment.

In a sense, land-dwelling creatures, including humans, owe their lives to diatoms. A large percentage of the oxygen we breathe is produced by diatoms, via photosynthesis. On diatoms, a large number of pores allow nutriment to enter and also allow exchange of gases. Diatoms work like micro-factories to produce oxygen. At the end of these gas exchanges, trillions of diatoms produce more oxygen than they need and make a vital contribution to the levels of oxygen in the atmosphere.

They also play a most important role in the marine food chain, since diatoms are the basic food source for the tiny creatures that constitute animal plankton. These, in turn, serve as food for larger animals, such as herring. Such enormous creatures as the humpbacked whale feed on nothing but diatoms. It takes a meal of hundreds of billions of diatoms to satisfy a humpbacked whale for only a few hours.

Diatoms' most impressive characteristic is the shells they build for themselves. Flawless architects, they make themselves homes out of opal (organic glass) in the sea. Some of these structures resemble a shining pine cone or a spiral, or a glittering chandelier. Interestingly, although there are more than 25,000 different species of diatom, their shells are all different. Just as with snowflakes, every single diatom species has a different appearance.



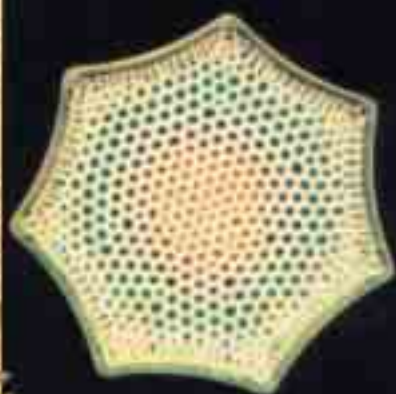
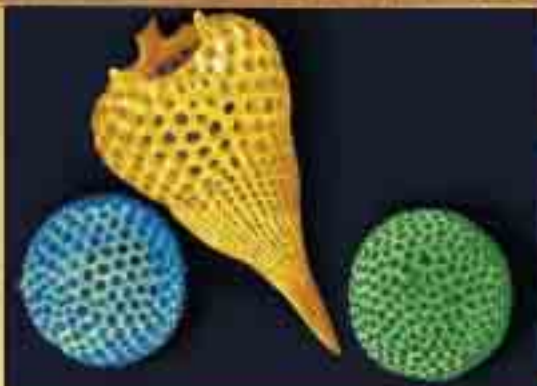



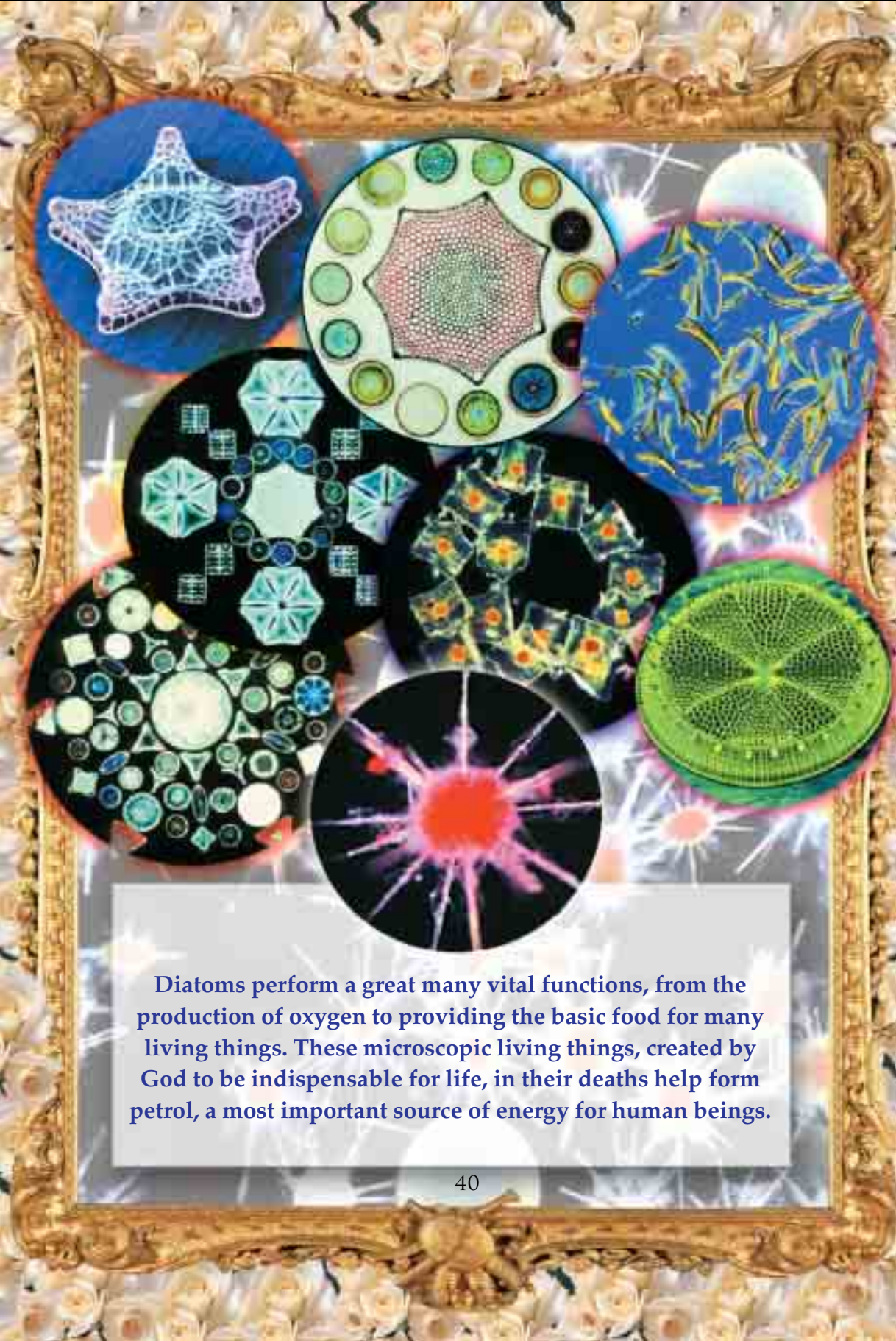

**Diatoms perform a great many vital functions, from the production of oxygen to providing the basic food for many living things. These microscopic living things, created by God to be indispensable for life, in their deaths help form petrol, a most important source of energy for human beings.**





Diatoms produce their shells by converting the silicon dissolved in water into silica, which resembles the precious stone opal. The glass-like shells that emerge as a result of this transformation display unimaginable variety and perfect architecture. The pores that let nutriments to enter and gasses to be exchanged make this structure even more fragile. Now, imagine an architect with very superior design abilities, but with either insufficient knowledge of materials, or else a lack of the necessary materials to create an architectural design. Clearly, design ability on its own can serve no purpose. Yet diatoms behave like architects with an incomparable design ability and also carry out, within their tiny bodies, a number of chemical adjustments to produce perfect structures.

Diatoms are microscopically small, the size of a pinhead and have no brain or nervous system. They produce beautiful shells, as if they had been trained in chemistry or architecture, which cannot be the work of chance. Moreover, all diatoms use the same materials to produce shells of completely different appearance, but all equally perfect. Their perfect architecture and infinite variety are of course manifestations of God's incomparable creative artistry.

• **Delicate Planning**

The most impressive moments that scientists studying diatoms can witness are those involving reproduction. First, the diatom's medicine phial-like shell divides in two. The diatom's nucleus then

splits in two, with each half entering a half shell. The demi- diatoms then set about completing their missing halves. The next-generation diatoms consisting of half cells are slightly smaller, and as they divide more times, these decrease in size still further.

Diatoms multiply very rapidly, some in just eight or even four hours. That means that in 10 days, just one diatom can form up to 1 billion offspring. Since diatoms are one of the world's most important sources of oxygen, there is no doubt that this is most essential planning. If they did not multiply so rapidly, the total quantity of oxygen produced would remain limited, and this ability of diatoms would be relatively meaningless.

In even the smallest factory, planning is necessary to regulate the speed and level of production. Otherwise the factory will either produce too much or too little, and will eventually be unable to create new sources for production. For that reason, universities give courses in production organization and planning.

But how do diatoms carry out planning? Can they possibly know how many they need to be in order to meet the world's oxygen needs, and how fast they need to multiply? Diatoms themselves cannot attain the knowledge that human beings can manage only after long, specialized training.

There is One possessed of will Who inspires in diatoms the necessary speed of reproduction and method to meet the oxygen needs of other living things. The possessor of that will is our Lord, the Lord of all, the omnipotent, Who guides all living things and inspires their actions in them.

• **The Ideal Raw Material Created for Human Use**

Diatoms' own nutriments are also important to human beings.



Harun Yahya



*Diatomite results from the fossilization of diatoms, which—with its light and porous structure—is ideal for filtering. This structure permits diatoms to be used for very different ends in the space industry, and in the manufacture of insecticides and paint filler.*

Adnan Oktar

These living things conceal within their cells nutriment in the form of tiny globules of fat produced thanks to photosynthesis. After diatoms die and sink to the bottom of the sea, these tiny particles gradually combine and, under the influence of geological and biological forces, give rise to the formation of oil deposits. Most of the petrol we use today was formed by diatoms that died in prehistoric seas.<sup>14</sup>

The bottom of a 30 million square kilometer area of the North Pacific and Antarctic Sea is covered with layers of dead diatoms that slowly fossilize and form diatomites, which are used for industrial purposes. With their light weight and pores, diatomites possess an ideal filtering structure. Due to that feature, in the same way that they can be employed in the space industry they can also be used for other different purposes, from the production of insecticides to paint filler.

Though most people are unaware of the existence of diatoms and the purposes for which they can be used, that doesn't diminish their vital importance. Diatoms are living things specially created to play a major role in the maintenance of a number of balances on Earth.

The way these living things employ special chemical processes to produce shells of perfect beauty and architecture is one of the blessings created by God for mankind. Characteristics of living things such as these, familiar and unfamiliar alike, let us better comprehend

the infinite might of God.

In one verse, He reveals:

**It is He Who created everything on the Earth for you... (Surat al-Baqara: 29)**

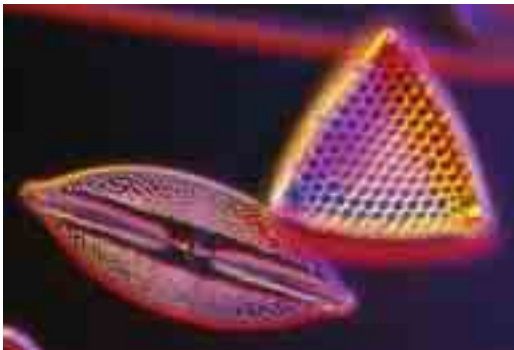



### **MULTI-DISCIPLINARY EXPERTS: KOALA BEARS**

The Australian koalas, among the best known marsupials, spend a great deal of their lives in the branches of eucalyptus trees.

The koala's physical design possesses all the features to let it live comfortably in the trees. For example, its arms and claws allow it to climb broad eucalyptus trees with ease, and on its hands, the first two fingers are separated from the other three. If we compare them to our own hands, we can say that in effect koalas have two thumbs. The large toes on their hind legs are also separate from the others, but like them, possess sharp claws. These large toes, different from the others, allow the marsupial to climb along smaller branches.

Like hooks, the koala's claws sink into the soft, smooth eucalyptus trunk, allowing the animal to climb. Its four feet cling onto the



branches, in the same way that we would hold a broom handle, and again allow it to climb upwards.

Another feature that allows koalas to live comfortably in eucalyptus trees is the special design of their stomachs. Eucalyptus leaves are poisonous, though the koala bear's special stomach lets it feed on them. The tree also provides the koala's needs for water. In doing all this, the koala makes use of medical science on the one hand and the biochemical factory in its body on the other.

Let us consider the koala's attributes in order:

• **The Koala's Medical Knowledge**

There are more than 600 species of eucalyptus in Australia, but koalas make use of only 35 of these. For the koala bear, the eucalyptus is not just a shelter, but an important food source. It's no exaggeration to say that the eucalyptus is actually its sole food, which also serve the koala as medicine.

Eucalyptus leaves possess a number of medicinal properties. They contain enteric oil, a chemical that is deadly to a great many animals. Yet the koala's liver is capable of neutralizing this oil, which is also the source of the koala's characteristic smell.

Some of the oil, which spreads over the whole body mixes with the air, and some enters into the body, causing parasitic insects to drop out of the animal's fur.

The harmony between the koala and the eucalyptus does not end there, since thanks to the eucalyptus leaves, the koala also regulates its body temperature.

The chemical substances in eucalyptus leaves vary from tree to tree. Indeed, two different types of leaf can be found on just one tree. Yet just as if it had received medical training, the koala selects those



Harun Yahya



*The two inner toes on the koala bear's front paws and the two inner toes on its back paws form a specific angle with its remaining other toes, just like our own thumbs do with our fingers. This perfectly designed structure makes the koala such a good tree climber. It's of course no coincidence that these attributes should be found in the koala, since they're the result of God's perfect creation.*



leaves it needs from among the hundreds on the branches. If its body temperature is low, and the animal feels cold, then it chews leaves containing the oil phellandrene. Similarly, if the koala is running a temperature, it chews leaves which contain a high level of cineol and thus cools its body down. Other oils in eucalyptus leaves reduce the koala's blood pressure and allow its muscles to recuperate.<sup>15</sup>

All these forms of behavior require expert knowledge. How does the koala know which species of eucalyptus contain the substances it needs?

No human being can know what substances a leaf contains simply by looking at it. But the koala does not only recognize different eucalyptus leaves, but also knows how to use them.

Even assuming that we can somehow know what substances the leaves contain, we cannot know what they can be used for without undergoing training or reading a treatise on the subject. Trial and error will be a rather dangerous procedure, since the leaves contain poisonous substances.

This means that the koala must not only identify the contents of the leaves, but also has to design a mechanism to neutralize their harmful effects. It must then somehow produce that mechanism in its own body, or it will die. That totally eliminates the irrational possibility that it does this by means of trial and error.

For any koala bear to survive, it must have come into being with its existing bodily structure; otherwise it will die. These conclusions are clear proofs that koalas came into existence with all these features already functional. There is clearly no room for evolutionary scenarios that have nothing to do with the scientific facts or with reason and logic. As will be considered in more detail later on, these creatures' body structure is the product of a perfect creation.

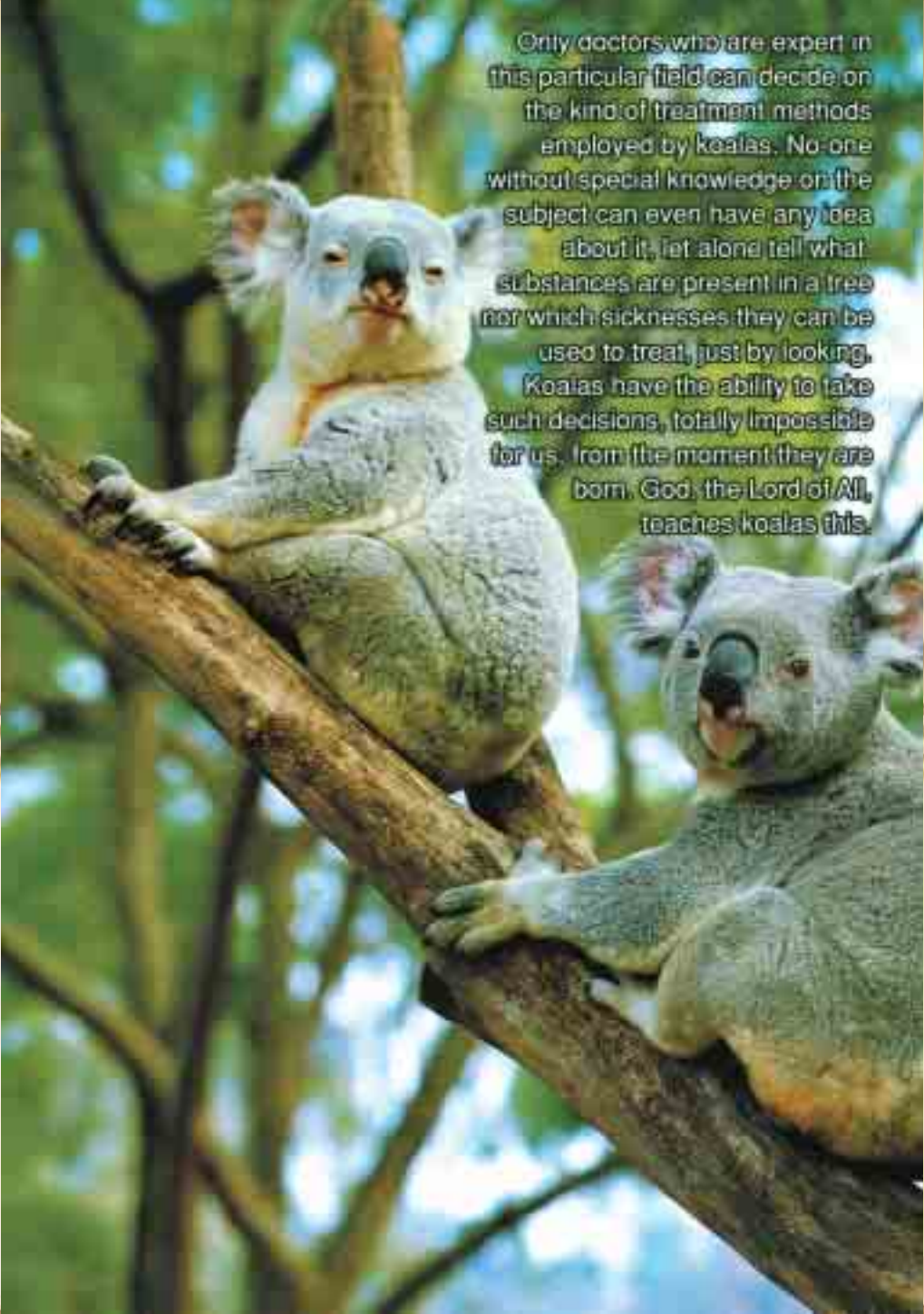

A photograph of two koalas sitting on a tree branch. The koala on the left is looking towards the camera, while the one on the right is looking to the side. The background is a soft-focus green forest. The image is framed by an ornate, golden-brown border with a repeating floral pattern of light-colored roses.

Only doctors who are expert in this particular field can decide on the kind of treatment methods employed by koalas. No one without special knowledge on the subject can even have any idea about it, let alone tell what substances are present in a tree nor which sicknesses they can be used to treat, just by looking. Koalas have the ability to take such decisions, totally impossible for us, from the moment they are born. God, the Lord of All, teaches koalas this.

Engineering in Nature

God has created the koala with features that let it use eucalyptus leaves in various ways. God possesses all forms of knowledge. Our Lord has ordained where the animal would be brought into being, along with its abilities, its appearance, and a great many other details.

God's creative artistry is flawless and matchless. In the Qur'an it is revealed:

**That is the Knower of the unseen and the visible, the Almighty, the Most Merciful. He Who has created all things in the best possible way. He commenced the creation of man from clay. (Surat as-Sajda: 6-7)**

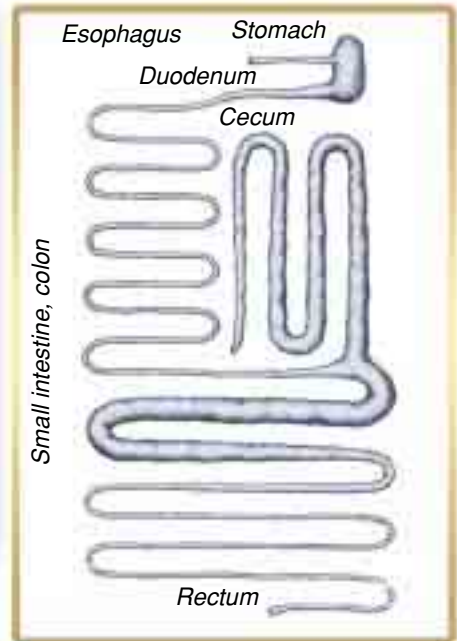



• **A Miniature Biochemical Factory**

Eucalyptus leaves contain high levels of fiber, low levels of protein, and strong-smelling oils, phenolic compounds, and cyanide, which is inedible and even lethal to many mammals. These substances lose their poisonous effects in the koala's body, because it possesses a digestive system with a very special anatomy and physiology.

Like other herbivorous mammals, the koala is unable to digest cellulose—the main component of eucalyptus leaves—on its own. That process is carried out for it by micro-organisms that can digest cellulose and live in the animal's cecum.

The koala's cecum opens onto the large intestine and is so large that it represents 20% of the total length of the intestines. Between 1.8 and 2.5 meters (6-8 feet) long, the cecum is the most interesting part of the koala's digestive system. There, the leaves' passage through the digestive system is delayed, and micro-organisms in the cecum go into action and make the cellulose usable by the koala. In that sense, the koala's cecum can be likened to a biochemical factory. As that factory processes the cellulose, oils and harmful substances (phenol compounds) are filtered and rendered harmless in yet another factory—the liver.

Since eucalyptus leaves are koalas' only food, all of the animal's carbohydrate needs are met by the digestion of cellulose by micro-organisms. Clearly, the koala could not live without them. Therefore, these two life forms must have come into being at the same time. This is proof that a single Creator created both koala bears and micro-organisms; that God created them both in mutual harmony.

God knows all the needs of all the entities He creates, and creates



them complete. Examples like these show us the infinite might of God. One verse reports that people using their reason will be able to grasp this truth:

**The Lord of the East and the West and everything between them if you used your intellect. (Surat ash-Shu'ara': 28)**

• **The Koala and Its Water Balance**

In the language of the Australian natives, the word *koala* means non-water drinking, since koala bears do not drink water. The reason is that koalas derive all their water from eucalyptus leaves they eat.

The free water content of eucalyptus leaves varies between 40% and 60%, but never drops below 40%, allowing the koalas with sufficient quantities of water.



But it's not enough for the eucalyptus leaves to contain large amounts of water. It's also vital that the koala's bodily system be able to make use of them. The koala possesses an utterly flawlessly created water-loss control system.

Water loss in koalas is regulated by the kidneys, but of greater importance is the water-retaining features of the koala's digestive system, which ensures that the koala's body expels only a small portion of the water it takes in.<sup>16</sup>

Thanks to its digestive system's water-retentive ability, the koala can easily assimilate eucalyptus leaves that, individually, contain low levels of water, but are present in large numbers. If the koala's digestive system did not possess this feature, the animal would have to descend to the ground regularly to look for water—very dangerous for a creature ill-adapted to living on the ground. Yet thanks to this special feature of its body, it never has to face that danger.

#### • **The Koala's Protective Fur**

The main element that determines the koala's body temperature is its fur, which can attain a density of up to around 55 hairs per cubic millimeter and has been created with perfect heat-retention properties.

The animal's back hair covers some 77% of the surface of its body, and has the highest insulation properties.

The stomach fur, covering 13% of the body surface, is only half as dense.

The length of the koala's fur varies according to the seasons. In summer, there is a greater difference between the long and short hairs.

The back fur being thicker than that on the stomach means that the koala can collect the heat from the sun and insulate itself. Although the stomach hairs are sparse, the animal can regulate the degree of insulation by causing these hairs to stand on end.

On windy days, the koalas in the trees simply turn their backs to the wind as it gains in intensity. More and more, they transform into something resembling a soft, furry ball. As the wind blows harder they also turn their ears forward, so that no open areas are exposed. The wind has little effect on this thick, mattress-like back fur, so that when the wind blows hard, the body can maintain its temperature unchanged. Even on cold days and in strong winds, the reduction in the fur's heat retention capacity is less than 14%. Even in the strongest winds, fur provides perfect heat retention for a tree-dwelling animal.

The koala also regulates the speed of its metabolism to complement the heat regulation its fur performs. The koala's metabolism is rather slow—only 74% of that of other placental animals, and one of the reasons why the animal experiences a low level of water loss.<sup>17</sup>

To recapitulate the features possessed by koalas:

Their body structure lets them climb trees and live there comfortably.

The special structure of their digestive systems let them obtain sufficient food and water from the plentiful eucalyptus leaves on the trees where they live.

Their physiological system eliminates the poisonous effects of the oils in the leaves.

They use certain eucalyptus leaves as drugs to rectify various imbalances in their bodies.

Their physiologies let them make maximum use of the the leaves' water content.



Harun Yahya



*All of these properties are essential for the animal to be able to live in the trees. Could these properties have come into existence by chance, and one by one? Of course not! It is Almighty God Who created the koala with all its flawless characteristics. To all the creatures He has created, God gives features such as these to demonstrate His infinite mercy and compassion.*

Adnan Oktar



*Chapter Two*

**The Perception  
Systems in Animals**







A

ll living things must know what is going on around them, or else they'll be unable to find food, protect themselves from danger, and find mates. Therefore, every living thing needs systems to let it distinguish objects and exhibit the necessary reactions in order to survive.

These special systems that tell them about external objects and direct their actions vary among species. The auditory receptors of a species of moth that needs protection from bats are sensitive to the high-frequency cries emitted by bats. Bats, in turn, hear the echoes of the sounds they emit at various frequencies, and manage to fly and hunt in the dark without hitting anything by analyzing those data. Similarly, salmon's olfactory systems allow them to swim for thousands of kilometers (hundred of miles) back to the streams where they were spawned. Whales communicate by perceiving the sounds they emit.

Direction finding systems, infra-red eyes and special hearing systems are just a few of the perception systems that living things employ. As will be seen from upcoming examples, one common feature of these systems is that all the components that permit perception are fully integrated with the other organs essential to survival. For instance, smell receptors in the nose are compatible with the smell center in the brain. The perceptions resulting from this harmony may have different meanings for each species, such that a living thing can distinguish members of its own species solely from their scent. Again, the receptors in a living thing's light-sensitive regions are entirely

compatible with the visual center in the brain. For instance, the snake's eye has sensor regions that are activated by heat rays. Nerve cells carry the image as it is to the brain, which then interprets these signals as heat waves.

Designs such as these could not possibly come into existence by chance, and are among the proofs that God created all living things. Considering such examples is important for understanding the mightiness and the limitlessness of His wisdom. The salmon is thus one of these proofs of creation.

### **THE SALMON'S ASTONISHING DIRECTION FINDING SYSTEMS**

In the rivers of the western shores of North America is born one of the world's most fascinating migrants. This is the salmon, which braves all kinds of difficulty in between rivers and streams and the open sea.

The salmon's life cycle begins when the female deposits eggs in the upper parts of a river or stream, has them fertilized by the male, and then covers them over with gravel (or sometimes sand).

Salmon generally deposit their eggs at the end of summer or in autumn. Following the incubation period, the tiny young usually hatch out at the end of winter. During their first few days, the young have a yellow yolk sac under their stomachs which contains the necessary foodstuffs for them. During this period, the young hide under pebbles that protect them from predators until their sacs are been used up.

A few weeks later, the salmon grow large enough to find their own food. They live in the river for approximately one year, while continuing to grow in size.



Salmon have been created so as to be able to live in both salt and fresh water. The purpose of this feature is revealed in the miraculous journey the fish will undertake.

With the arrival of spring, thousands of salmon begin to migrate along the river bed.

The exact start of the migration varies according to the particular species. For example, the young of the pink salmon begin migrating towards the sea as soon as they hatch out from their eggs. Other species, like chum salmon, head for the open sea after feeding for a few weeks; while king and Atlantic salmon do so only after completing their development in the rivers for between one and three years.

During their first migration, the young salmon "go with the flow," progressing along the current of the river. On their journey to the sea, they may encounter various dangers such as whirlpools, polluted waters and predators. At the end of this journey, which will last for



*This map shows the routes taken by salmon after reaching the sea.*

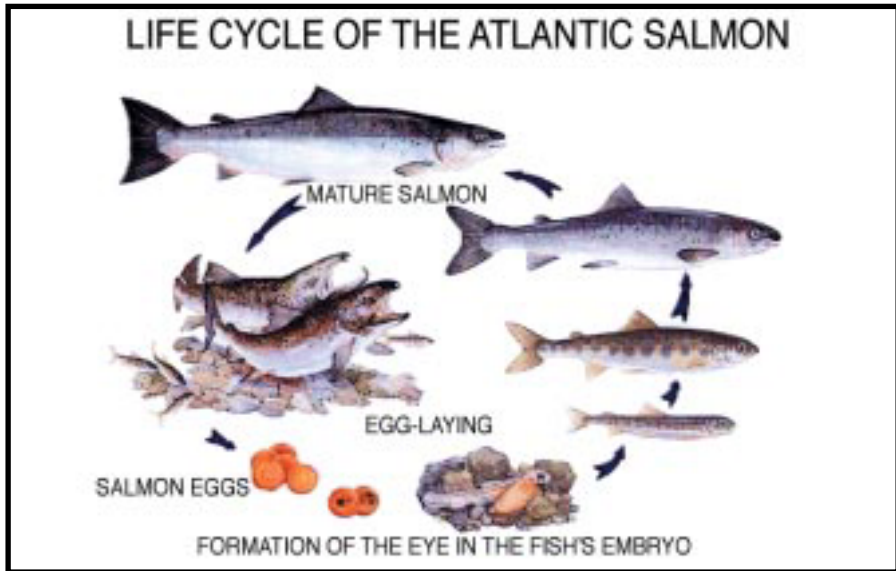

*The above picture shows the developmental stages that salmon undergo from birth until they complete their migrations.*

several weeks, those who survive to reach the open sea thus complete their first migration and finally reach their objective, the Pacific Ocean. After spending a few years in the sea, those which grow to full maturity embark on another, really astonishing, migration.

As the salmon swim down the river, a number of physiological changes take place. From being creatures that live in fresh water they adapt to the salt waters of the sea. After spending a while at the mouth of the river in order to acclimatize themselves to salt water, they move to the ocean where they will spend most of their adult lives.<sup>18</sup> When the fish return to the rivers to lay their eggs, this process is reversed.

- **The Salmon's Difficult Journey Begins**

The salmon now begin swimming against the current, up the same



river that years earlier, they descended to reach the sea. No obstacle can deter them. When they come across waterfalls, they leap into the air and continue on their way. They are capable of surmounting obstacles as much as 3 meters (9 feet) high.

Their objective at the end of this return journey is the place where they hatched, where they will lay their own eggs. Atlantic salmon undertake this journey every year, while the other species migrate only once in a lifetime. These migrations present a number of difficulties, which we can briefly summarize.

The first of these is the distance the fish need to travel. In order to reach their natal rivers the salmon need to swim thousands of kilometers. For example, many Atlantic salmon travel roughly 4,000 kilometers (2500 miles).<sup>19</sup> During the egg-laying period in autumn, the chum salmon swims more than 3,200 kilometers (2000 miles). A red salmon travels more than 1,600 kilometers (1000 miles).

As soon as they reach the ocean, a structural change takes place in the salmon's bodies that enables them to survive in salt water. Over the next one to four years they will travel enormous distances through the ocean. Leaving the American coasts, they travel along the Alaskan coast towards Japan, returning by the same route. At the end of the journeys, the salmon have matured and are ready for the last and most difficult journey of their lives: the return home, to the fresh-water beds where they were born.

The salmon's timing is ideal. They plan their long journeys to coincide with the spawning periods. The Atlantic salmon, for example, swims an average of 6 to 7 kilometers (3 to 4 miles) a day to reach its destination; the migration it begins in late spring is completed towards the end of autumn.



Engineering in Nature

*In order to lay their eggs, salmon risk their lives by travelling thousands of kilometers under exceptionally difficult conditions. Why do they undertake such a journey, and find their way over such long distances? Almighty God, Who enables them to travel up rivers to reach their destinations, has created them with a perfect direction-finding system. Like all other living things, salmon use the special systems God created for them and behave according to the inspiration they receive from Him. All these perfect systems reveal the grandeur in God's creation.*





Harun Yahya

Adnan Oktar

63

• **Problems Salmon Have to Overcome**

On its return route, the salmon must first find the mouth of the river where it was hatched. Salmon never make a mistake in this regard. On their first attempt, they're easily able to find the mouth of the river that opens into the ocean.

Entering the river, a salmon begins to swim with great determination against the current.

In order to reach its objective, the salmon struggles against the river's powerful current. It overcomes the waterfalls and similar obstacles rising up before it by leaping sometimes as high as 3 meters (10 feet) in the air. Sometimes it passes through water so shallow that its upper fin is exposed to the air. In these shallow waters, it faces the danger of predators such as eagles, hawks and bears that wait for it.

In order to fully understand the perfection of the salmon's journey, consider what it must keep in mind to reach its destination:

First, to determine its route, it needs to take a number of important decisions. The fish are hatched a considerable distance inland, in any of the river's number of various branches. Thus the salmon must correctly select every fork in the river. Yet





Harun Yahya

they are able to find their way on a journey they undertake only once in their lives, and select the correct forks in the river which leads to their ultimate destination.

Throughout its arduous journey, the fish expends enormous energy, yet it never takes on any nourishment. Before setting out on its exhausting journey, it has stored all the energy it will require. That storage and the fish's needs have been finely out with flawless calculation.

In examining the salmon's migration, one must also bear in mind such factors as the salinity levels of the rivers and the sea and the water temperature. Salmon possess the equipment that allows them to harmonize completely with both fresh water and salt water environments.



Adnan Oktar

Despite all the difficulties, salmon complete their journeys, returning to where they were born to lay their eggs. Generations of salmon have undertaken this magnificent journey for millions of years.

The measure of the salmon's achievement can be better grasped by a few comparisons. Imagine that someone had to travel thousands of kilometers to the house where he was born, with no help and not using any sort of vehicle. It's impossible that he would be able to do so within a specific time frame, over roads and obstacles he had never encountered before. Yet salmon possess the means to do this, from the moment they are born. Clearly, however, this ability cannot come about through the salmon's own efforts. Chance can never endow this species of fish with greater abilities than those of human beings.

These creatures can complete their journey of thousands of kilometers thanks to the special designs created in their bodies by God. Every thoughtful reader can immediately see the miraculous aspect of the salmon's achievement and realize that this is performed with the guidance—in other words, the inspiration—of a superior power.

In one verse, God reveals that there are lessons for mankind in the living things He has created:

**There is instruction for you in cattle...(Surat an-Nahl: 66)**

• **The Salmon's Scent-Detection Mechanism**

The journeys that salmon undertake are one of the most astonishing phenomena in nature. How do thousands of salmon recognize the riverbed where they were hatched, after spending years at sea? They first need to find their birthplace from among the thousands of rivers that pour into the Pacific Ocean, then swim the length of it, then taking the correct fork whenever the river branches.



**“There is instruction for you in cattle...”  
(Surat an-Nahl: 66)**

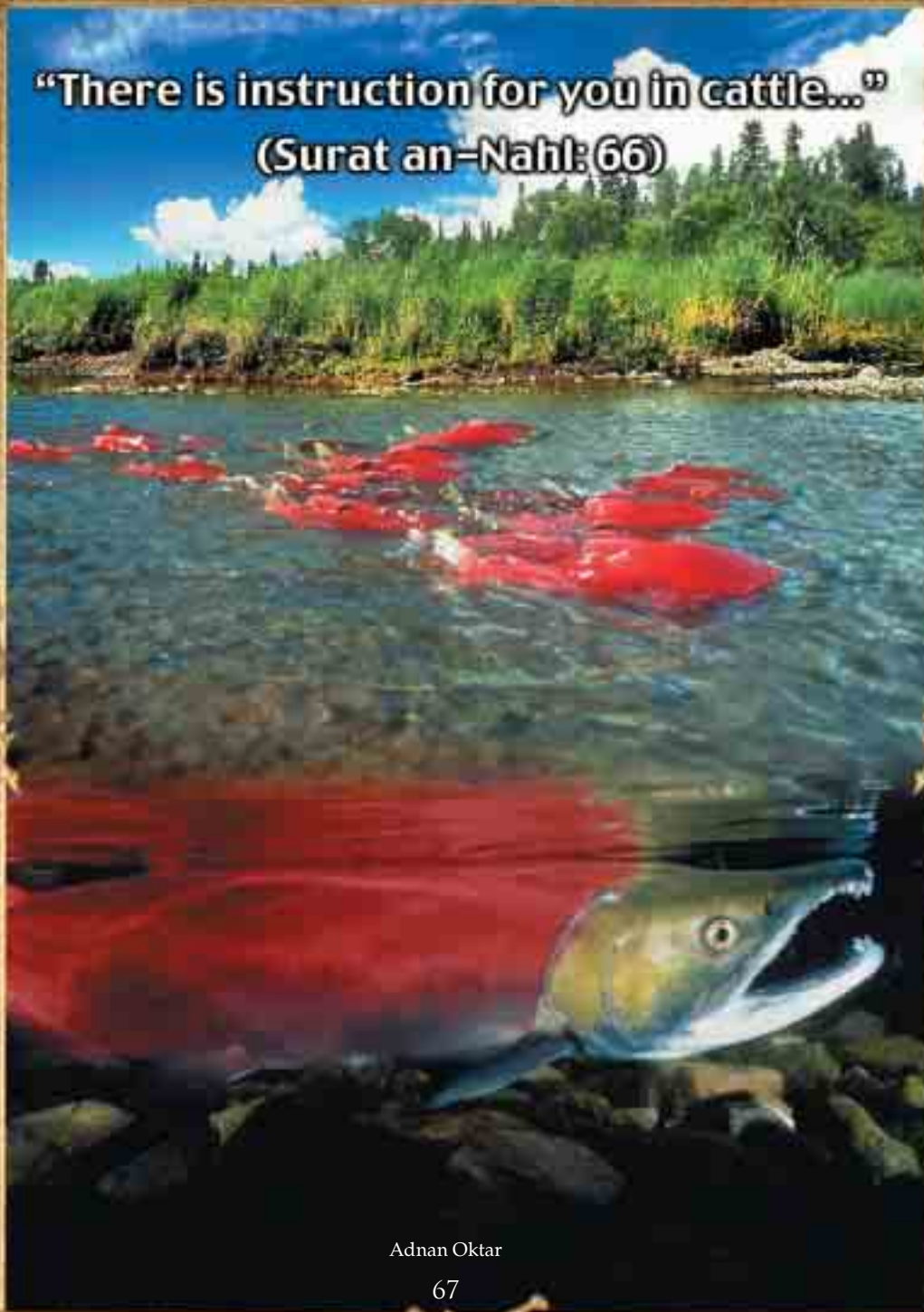

Adnan Oktar

All the salmon that have lived for millions of years have achieved the same success in this enormously difficult task.

Let us first turn our attention to the question of how?

Researchers indicate that salmon have a special sense to allow them to complete this journey. To find their way in the oceans, they've been created with a natural compass that perceives the Earth's magnetic field, allowing them to successfully navigate in the waters of the Pacific.

The real question, however, is that of how the salmon find the river bed they were born in—an achievement requiring a very different system from that of the compass.

In the Wisconsin Lake laboratories in America, various studies were carried out to establish how salmon accomplish this impressive journey—and it emerged that salmon use their sense of smell to find their way.

Salmon have two nostrils. Water enters through one and exits through the other. These holes are designed to open and close at the same time as the animal breathes. When water containing any substance with a scent enters the nose, receptors there are chemically stimulated. An enzyme reaction converts this chemical stimulus into an electrical signal, which is transmitted to the central nervous system.

That is how the fish smells. But let us compare the salmon's sense of smell to those of land-dwelling creatures:

In land-dwelling vertebrates, smell takes place when scent molecules dissolve in by the mucus layer in the nose. But in fish, there is no such dissolution stage, because the smell is already dissolved in the water. This gives salmon a great advantage, thanks to which they can follow the source of a smell like very skilled hunting dogs.



The Wisconsin Lake laboratories first sought to answer the question of how much fish can differentiate between various smells. To that end, an aquarium with special channels was designed and with a pipette, the smell of a different plant was placed into each one. In the experiment, only fish that used a channel with a particular scent were rewarded, while fish using other channels were punished by a mild electric shock. The processes were repeated using 14 different smells. At the end of the experiment, it was observed that after a brief learning curve, fish were able to distinguish the smell leading to a reward on every occasion. Another important finding was that young fish in the experiment were able to identify the correct smell even three years later.<sup>20</sup>

Based on the results of the study, scientists concluded that fish possess a sense of smell incomparably more powerful than that of human beings.

Every stretch of water has its own particular aroma. Young salmon record the smells they encounter, one by one, during their first journey to the sea. On their return journey, they can find their way with



*Salmons' direction-finding system is far superior to any advanced man-made technology. Almighty God, the Creator of all living things, has created salmon together with these perfect features.*

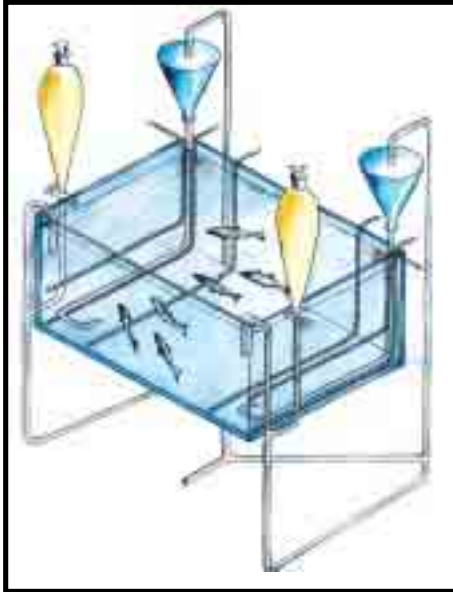

*An experimental training tank, built in the Wisconsin Lake laboratories, to permit fish to distinguish between two different smells. In this contiguous body, the upper left part of the tank has two different scents in the yellow containers. When the valve in one of the containers is opened, the scent enters the tank. The fish in the experiment were blinded to prevent them using their sense of sight. When they head for one of the scents, they are rewarded with food, but when they move towards the other scent, are punished with a mild electric shock. After a brief test, the experiment was halted. When the fish were put back into the tank three years later, it was observed that they headed straight for the scent which had earlier led to their receiving a reward.*

the help of the smells stored in their memory banks.<sup>21</sup>

To answer the question "Does each current have its own particular smell?" the experiment was repeated with water from two different rivers. Indeed, the fish were able to distinguish between them.

In fact, every river in the world has its own individual chemical compound. The differences between these are usually so small that very few creatures—apart from salmon—can detect them...

The research on this subject was taken one step further in fishes' natural habitats. Fish with their nostrils specially sealed were observed in the Issaquah River in Washington, and thus deprived of their sense of smell, they were confused and unable to find their way.<sup>22</sup>

The results of all the research carried out to date indicates that the salmon's sense of smell is so sensitive that it amazes human beings.



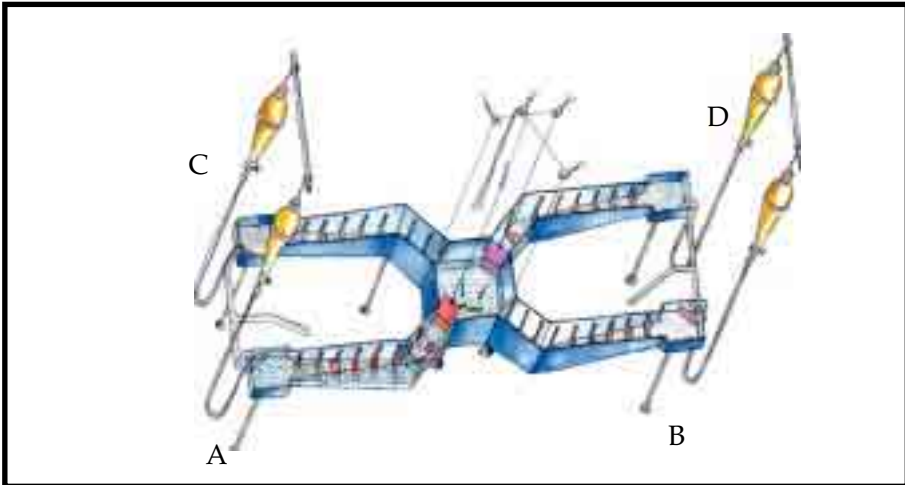

*The mechanism above was prepared to help understand the role of the sense of scent in the journeys made by salmon. In the central pool meet four artificial water currents. Of these, current A was given the scent of the tank in which the fish had been placed just before. The other currents (B, C and D) contained different scents. When the covers in the central section were opened, the fish moved against the current containing the scent they had lived with before.*

#### • **Salmons' Determination**

A discovery at the Prairie Creek Fish Breeding Farm in North California revealed salmon's direction finding abilities in an incredible migratory adventure.<sup>23</sup>

On December 2, 1964, a large, two year-old salmon was found in one of the breeding pools swimming amongst the hundreds of young fish. Examined close up, a Prairie Creek Fish Breeding Farm metal clip was seen on its back fin. This shows that the fish was one of those that had been released into the ocean two years before, after having been reared at the farm. But how could the salmon have returned from the ocean to enter the farm's closed fish breeding pool?

## Engineering in Nature

There were two clues. One, the box with a grill lid, opening into the channel used to empty excess water from the pool, was found broken. Could the fish have entered the channel in order to return to its birthplace and then have entered the pool by breaking the metal lid?

It seemed incredible that the salmon could have made the long journey from the ocean to the pool. Yet there was no other explanation.

In order for the salmon to return to the farm, it must have begun its journey from the point where Redwood Creek joined the ocean. The fish would then have to have swum 5 kilometers (3 miles) against the current before reaching the first fork; then have made the correct choice and turned north, before coming to a more difficult parting of the ways. At this point, from the salmon's point of view, there were two very similar signals. The farm where the salmon was born was lo-





cated exactly in the middle of the fork. The first choice was for the salmon to turn right, because the farm waters flowed from that direction.

Yet for some reason, the fish selected the left fork and managed to approach from behind the farm where it had been born.

The reason for its astonishing decision lay beneath the main road that ran through the region. Under that road was a channel into which the farm's excess water was discharged. Under normal conditions, very little water entered this channel, and what there was leached into the forest soil before ever reaching the river. But that year had seen heavy rainfall, and the water in the channel had reached the river. For a salmon determined to find its birthplace, that shallow stream was enough to show the way.

Following that familiar scent, it evidently must have left the river and moved up the length of the water channel. Entering the channel, it swam and crawled through some depths of only 5 to 10 centimeters (1.5 to 4 inches). Then, moving through the darkness of the tunnel, it must have crossed underneath the road and leapt into the channel's special water pipes, which were at a considerable height. Yet even had it managed to do all that and approach its objective in the darkness, it would still find itself blocked by the cover, trapped in a concrete channel underneath this wooden track in the fish breeding farm.

Yet the salmon had been programmed to find the spot where it had been born. Finding the 12-centimeter (5-inch) entrance to the pipe leading to the pool, it moved along that and encountered a final obstacle: the metal grill placed in front of the pipe... Yet the salmon overcame this with a sharp blow from its nose.

At the end of this arduous journey, the fish reached the pool where

it had been born two years before.

After calculating the route it had taken, the farm personnel wondered if other salmon had returned? On the chance that they might find something, they removed the wooden planks of the track and examined the channel underneath. To their amazement they found 70 more salmon, all bearing the metal tags of the breeding farm!

This incredible tale provides us with some very important evidence regarding creation. The journey carried out by these fish occurred thanks to various systems, every phase of which had been carefully calculated.

It's a miracle by itself that a program should command the fish to go to the sea after being born, to spend years there, then return to the riverbed where it was spawned. In addition, the fish also has:

Genetic information letting its body adapt to salt water from fresh water, in line with that program,

A natural compass that lets it find its way with total accuracy in the vastness of the ocean, and

An exceedingly sensitive sense of smell to locate the exact riverbed where it was hatched.

All this clearly shows that the salmon has been specially created to perform the migration set out for it.

By itself, every one of these perfect systems is no doubt sufficient to demolish the claim of chance put forward by evolutionists. The salmon's journey is a marvel of planning and design that renders ridiculous the concept of chance.

It is Almighty God, the Lord of the Worlds and the Creator of all living things Who created salmon with all their marvelous properties.



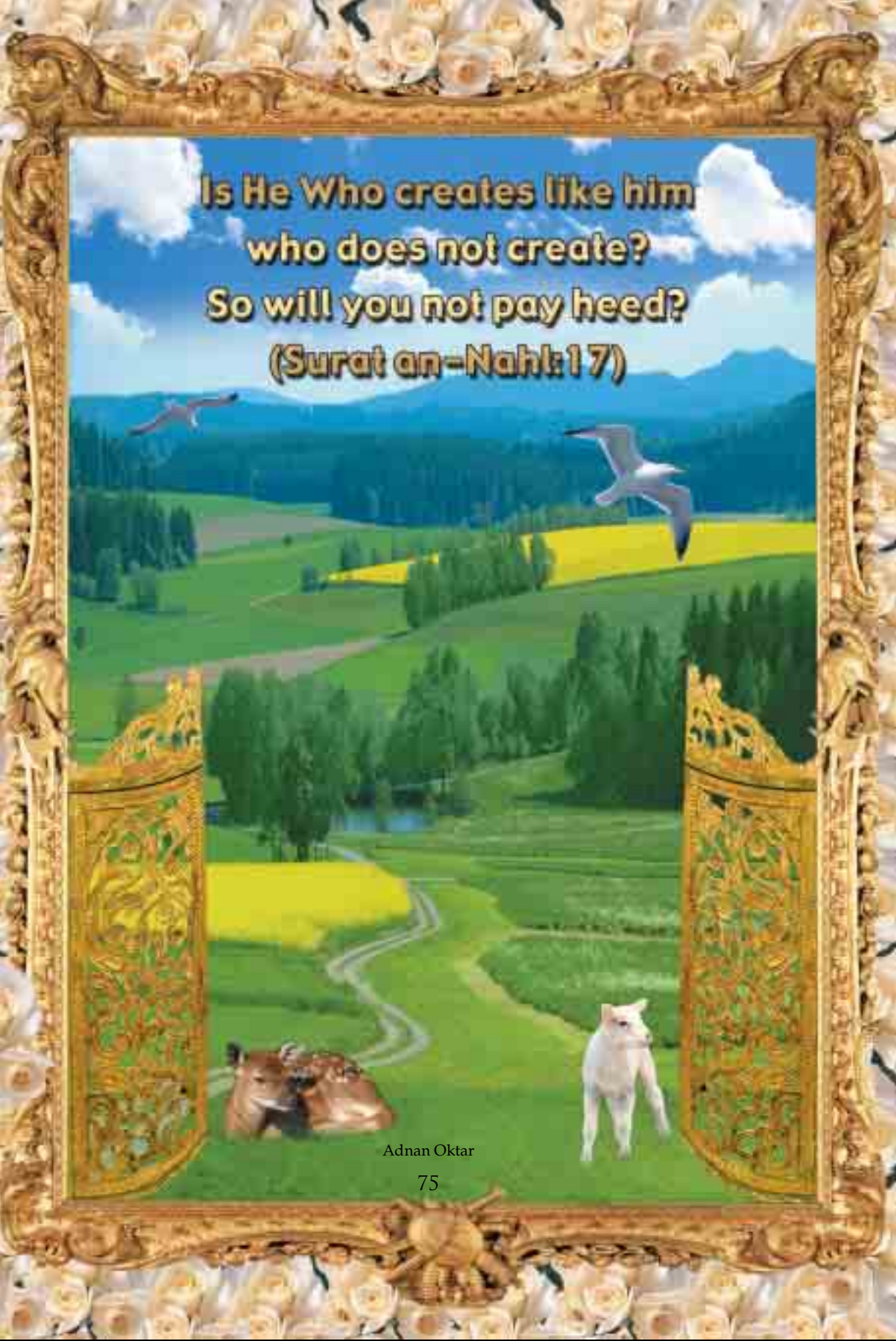

**Is He Who creates like him  
who does not create?  
So will you not pay heed?  
(Surat an-Nahl:17)**

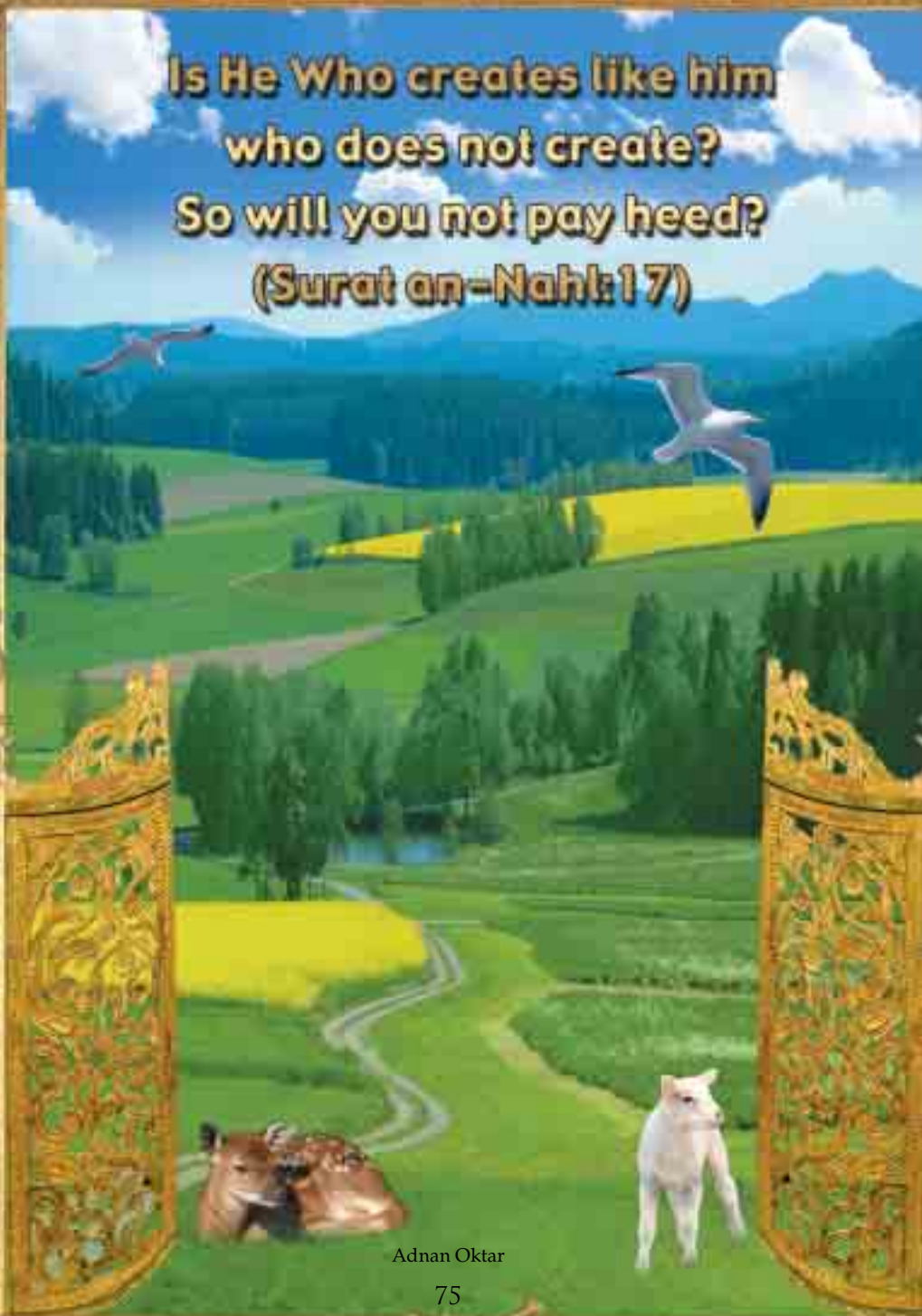

Adnan Oktar

• **Evolutionists' Errors Regarding Instinct and Natural Selection**

The salmon's migratory journey and direction-finding mechanisms are just two of the many facts that place Darwinism in an insuperable quandary. Asked how salmon find their way, evolutionists reply, "By instinct."

Instinct is a word behind which evolutionists hide, baffled in the face of rational and conscious behavior. Yet the meaning and nature of instinct are unclear. What is the origin of instinct? How did such behavior first emerge? Evolutionists are unable to provide a clear and unambiguous explanation to such questions

Of course, the concept that evolutionists describe as instinct can't possibly enable salmon to find their way "home." Instinct would have to describe to a salmon every river it would pass and let it to find its way without fail in the face of all the alternative routes. Such a thought is manifestly illogical.

The behavior of salmon also deals a lethal blow to evolution's natural selection, according to which, all living things are engaged in a ruthless struggle for survival, in which only the strong survive.

However, the altruistic and cooperative behavior among most organisms refute this evolutionist claim. The salmon's behavior, for example, renders the natural selection claim meaningless.

Why do salmon risk their lives undertaking a journey of thousands of kilometers (hundreds of miles)? Why do they abandon their rich food supply in the sea? Why make a migration that provides no advantage to them as individuals? Why do they lay their eggs in river branches thousands of miles away, rather than in the sea where they are at the time, or in the mouths of rivers?

According to evolutionists' theories, salmon should engage only in behaviors that will help them survive. But on the contrary, salmon en-



danger their own lives in embarking on a most difficult journey to lay their eggs. God, the Lord of the Worlds, inspires in salmon the direction they will take, as He does with all other living things. It is Almighty God Who creates the direction-finding systems in salmon and guides them to travel along rivers and arrive at their destinations.

In one verse God reveals that all living things are under His supervision:

**... There is no creature He does not hold by the forelock. My Lord is on a Straight Path.' (Surah Hud: 56)**

Salmon use the special systems God created for them and, like all other living things, act in the manner inspired in them by Him. These are all proofs that reveal the splendor in God's creation. The life of the salmon is one of the beauties in God's art of creation. Details like these in the variety of living things on Earth must cause human beings to think and to turn to God.

### **MOTHS' AREA OF EXPERTISE: ULTRASONIC WAVES**

For any animal to survive, its most urgent need is to identify predators and prey. Some species of moth have a major advantage in this regard, since they can hear the high-frequency sounds emitted by bats as they hunt.

A number of scientists and students at Tufts University examined the central nervous system of nocturnal moths. Their aim was to decipher the code system of the perceptions linking the central nervous system to the moth's ear and to determine how the moths managed to escape the bats, their greatest enemy.<sup>24</sup>

Engineering in Nature

**Your Lord, He is the Creator,  
the All-Knowing.  
(Surat al-Hijr: 86)**

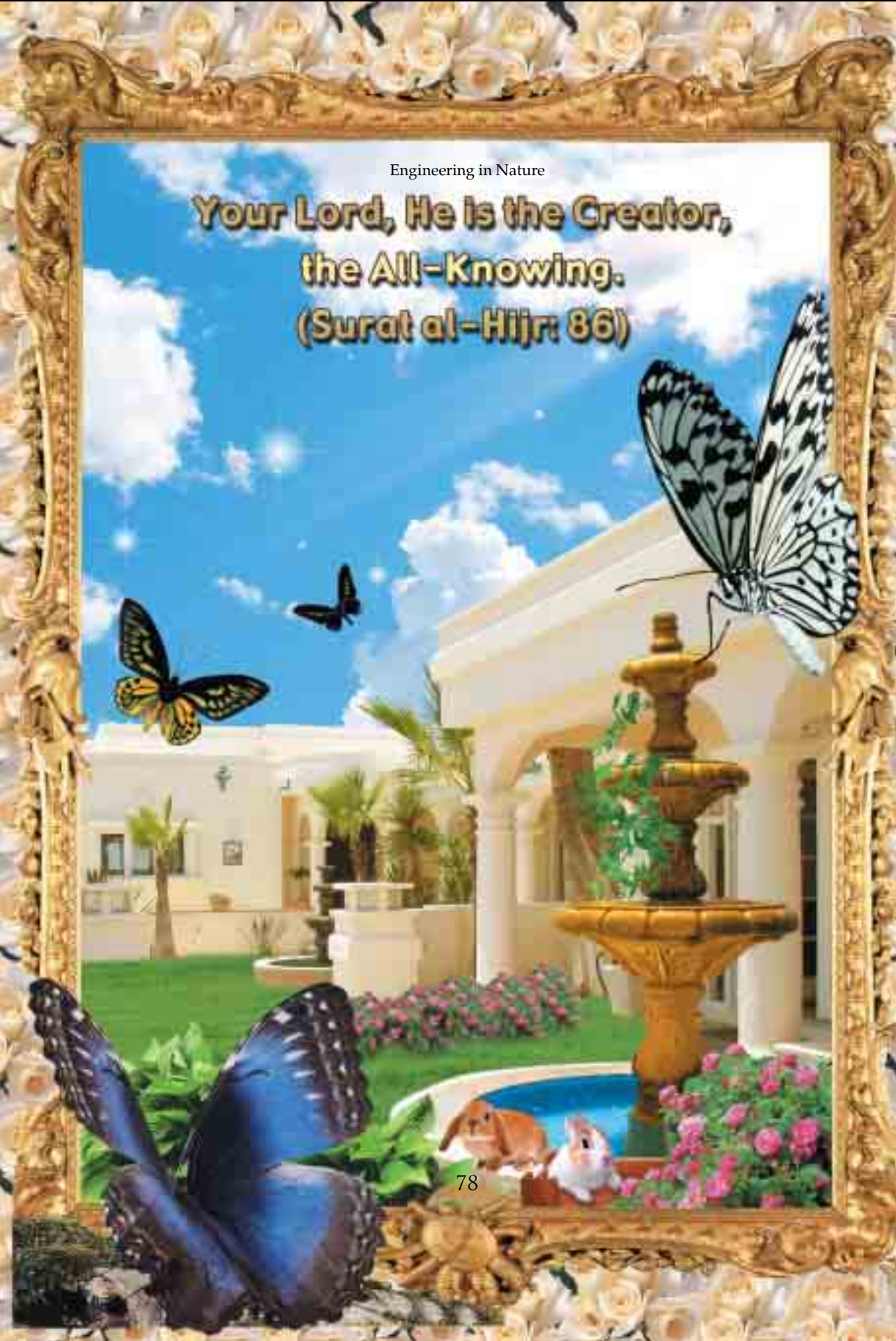



The study established that a special system in the moth's ear had infiltrated the bat's hunting system. From the ear, perceptions regarding the bat are sent to the central nervous system by means of only two fibers. This system, apparently so simple, is perfectly created to let the moth perceive ultrasonic waves.

• **Capturing the Enemy's Battle Plan**

As insectivorous bats hunt in the dark, they give off a series of high frequency cries. They locate prey by establishing the direction and distance of the source of these cries' echoes. This acoustical radar is so sensitive that it even permits bats to catch insects as tiny as mosquitoes. But some species of moth – members of the Noctuidae, Geometridae and Arctiidae families – possess ears capable of hearing the ultrasonic cries emitted by bats, so that they can escape being hunted down.

These ears, located under the moths' wings, serve as an early warning system.

When they sense a bat emitting high-frequency sounds, moths make sharp dives or intricate loops, very different from their normal flight patterns. Sometimes they fly in the opposite direction to the approaching bat. Asher E. Treat of New York City University observed that moths flying in a different direction to a bat's approach have a better chance of survival than others.<sup>25</sup>

The moth's ear can detect ultrasonic bat cries, which we humans cannot, from up to 3,200 meters (10500 feet) away. In addition, they can also distinguish frequencies from 10 to 100 kilocycles—a range that includes bat cries. Their greatest ability, to identify short bursts of sound amidst periods of silence and the differences in their sound range, give moths a major advantage in their battle for survival.

In war, of course, it's very important for one country to get hold of its enemy's battle plan. Knowing the weapons and tactics the enemy will employ will make victory—or at least, survival—much easier. The advantage that a moth attains over bats is due to its being aware of the main tactic they use to attack. This of course, is a result of the moths' flawlessly designed creation. If the moth could not hear sounds as far away as the bats could, then the moth's ears couldn't protect it. By the time the moth detected the bat and sought to evade it, the bat would have homed in on it and caught it, due to its faster flight speed. Or the moth might perceive an approaching bat as actually farther away, or misinterpret the bat's location.

Yet from among all these alternatives, moths select the right course of action to avoid falling prey.

In one verse God reveals, "**God is watchful over all things.**" (Surat al-Ahzab: 52) The moth's hearing is one of the countless proofs of this.

Like all other living things, moths survive thanks to the perfect systems He has created in their bodies and inspired them to employ. With the inspiration of God, they engage in rational behavior and make the right choices.

#### • **More About Moths' Perfect Hearing System**

The book "Animal Engineering", based on articles published in *Scientific American* magazine, reveals the flawless complexity of the system in moths' bodies:

Moths' ears are located to the side of the lower part of their thorax, in a small passage that separates the insect's chest and stomach. Seen from outside, the ears resemble two small cavities, each containing a transparent membrane.

Immediately behind the membrane, in that part of the passage



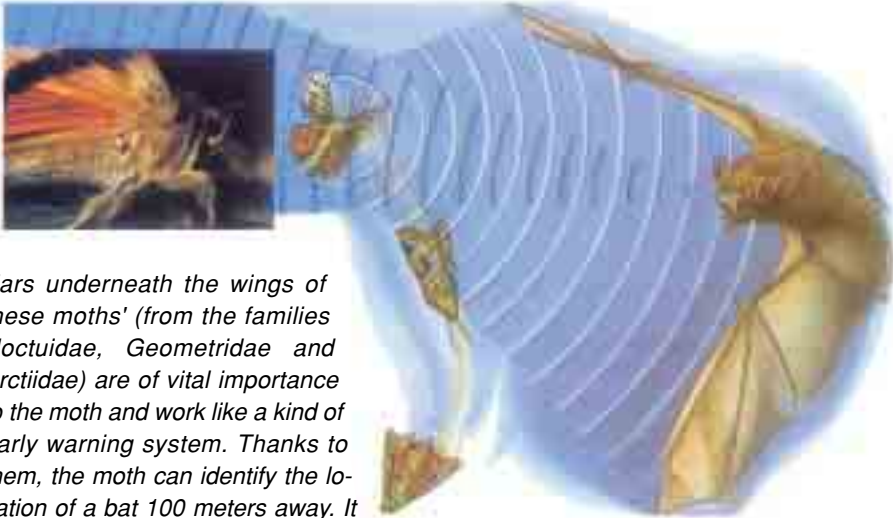

*Ears underneath the wings of these moths' (from the families Noctuidae, Geometridae and Arctiidae) are of vital importance to the moth and work like a kind of early warning system. Thanks to them, the moth can identify the location of a bat 100 meters away. It can even tell whether the bat is flying past it or approaching, initiating an attack. The moth's ears have been created in such a way as to be able to perceive the very high-frequency sound waves emitted by bats.*

known as the middle ear, is an air sac. Fine tissue containing the components of the moth's hearing system extends along the length of the air sac, from the middle of the ear membrane to the exoskeletal support. At this point are two hearing cells known as A cells. Attached to them is a third cell, known as the B cell, with no direct connection to sounds.

Every A cell extends a single nerve fiber outside to the ear membrane, and inside to the exoskeletal support. All the information regarding high-frequency sounds the moth detects is transmitted to the central nervous system along these two A fibers. Both A fibers, known as A1 and A2 pass very close to the large B cell. The B cell also has a

nerve fiber and after a short distance, the three fibers join and fibers continue on to the moth's central nervous system, combined, as the middle ear nerve.

Electrical signals in the nerve fibers carry an electrical charge of  $1/2000^{\text{th}}$  of a volt. The signals in the moth's A fibers reach the central nervous system from the sensory cells in as little as  $1/2000^{\text{th}}$  of a second.

These nerves have the capacity to perceive the sound waves that bats emit. Moreover, they are very sensitive when it comes to identifying the magnitude of their waves and the changes between them. Thanks to all these features, the moth can distinguish between the squeaks of a distant bat from the louder, stronger ones approaching to catch it. <sup>26</sup>

• **How Do Moths Make This Distinction?**

To answer that question, scientists started by determining which information reaching the ear the moth analyzes, and how it arrives at an interpretation. Some of the details they discovered eliminate the evolutionists' "random changes" claim:

Scientists took measurements with an oscilloscope, which registers microscopic electrical currents. When a bat squeak stimulates the moth ear, liquid levels in the oscilloscope reveal that the A cell immediately goes into action. As the signal's strength increases, changes are observed. First the magnitude of the signals rises, then the time lag between them falls. Rises are observed in both A fibers at once, though the A1 fiber is more sensitive to sound than the A2 fiber. And the greater the intensity of the signal, the faster the A cell produces a rise.

To scientists analyzing this information, new questions await. In



the face of an increasingly strong signal, what changes in the moth's auditory reaction determine its behavior? Using the estimating method, which is called the moth's perspective, scientists arrived at the following conclusions:

The moth's reacting to the first kind of information – in other words, rises in the A fiber–might cause it to make a lethal error: The moth might confuse a long, weak squeak from a far-off bat with the strong squeak of one approaching to kill it.

Such a mistake can be prevented only if the moth uses the second data – the gaps between the peaks – to determine the magnitude of the bat squeak.

The third type of data – the activity of the A2 fiber – may serve to turn an early warning message into a "Take action" one.

A fourth type of data, a sharp peak, is needed to give the moth the information it needs to locate a moving bat. For instance, if the sound is stronger in the moth's left ear than in the right, then the A peaks will reach the left part of the central nervous system a millisecond more quickly than they do the left.

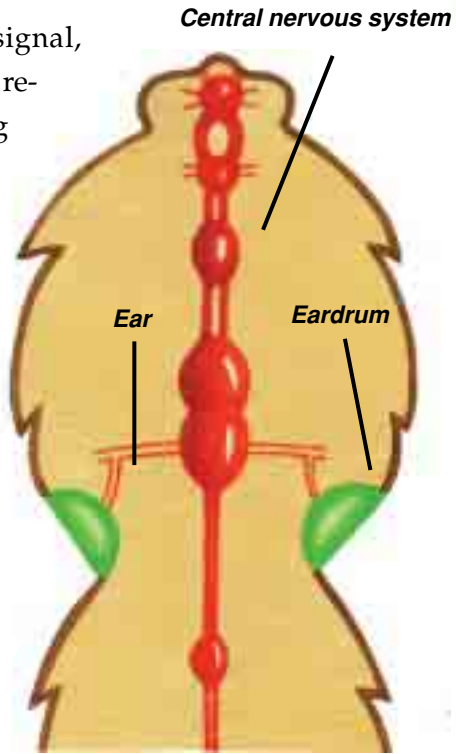

*The moth's ear and how it's connected to its central nervous system.*

These are estimates regarding the possibilities the moth uses in deciding about the bat and the sort of system employed. There is also the behavior of the moth that can be clearly observed.

When identifying and attacking prey, bats emit increasingly dense sound waves. If the moth perceives a weak sound coming from opposite side, the moth immediately changes course, returns and moves away, leaving the bat behind it. That's because the weakness of the sound means that the bat has not yet located the moth and therefore, has not yet begun pursuit. That is because bats emit increasingly dense sound waves when identifying and attacking prey. A moth which detects weak waves changes direction and moves away, leaving the bat behind it. If the moth detects dense signals, it either makes a sudden dive towards the ground, or makes a series of acrobatic maneuvers of sharp turns to escape the bat.

#### • **The Moth's Support Systems**

The moth's two ears let it locate the direction of the sounds it hears. If the bat is to the moth's left, sound waves coming from the that direction are detected about  $1/1000^{\text{th}}$  of a second before to those coming from the right. This perception gap between the two ears is enough for the moth to locate the source of the sound.

Nor is this the end of the moth's ear's astonishing features. Some moths' ears are covered with a membrane-like structure that serves in much the same way as our external ear. By collecting sound, it contributes to the strengthening of hearing capacity.

In addition, some moths do more than just detect ultrasonic sounds, but can also emit them. When these moths detect a bat, instead of fleeing, they emit ultrasonic sounds of their own. One might imagine that to do such a thing would mean committing suicide for a



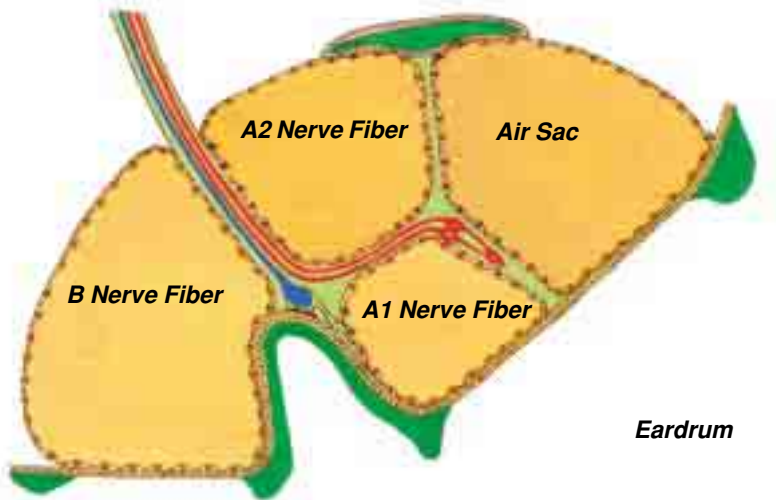

*The nerve fibers and acoustic cells in the moth's auditory system.*

moth. Yet contrary to what you might expect, when bats encounter such moths, they prefer to move off at high speed.

Scientists think there may be two bases for this behavior:

1. The ultrasonic sounds emitted by the moth interferes with the bat's own perception system.

2 – Sound-emitting moths do not taste good to bats. When the bat hears such a sound, it thinks it has encountered an unpleasant tasting prey.

Reviewing what we've described so far, a manifest consciousness can be seen in moths' behavior as well as a flawless design in their bodies. The features that let the moth detect ultrasonic sounds, interpret them, and send out waves of its own are all requiring separate

designs:

The moth's ability to hear the bat is possible thanks to a complex series of processes. If you do away with any one—the perceptual difference between the A1 and A2 fibers, for instance—the moth will be unable to distinguish the direction of the bat squeaks. Or if the structure of the ear membrane is defective, the moth will be unable to hear anything at all. But on its own, a moth's ability to hear the sounds emitted by bats means nothing. In order for the insect to survive, it must have a nervous system that can respond to a predator's presence.

And in that nervous system, the reactions that let enabling the moth to escape by setting specific muscles into action, need to take place in order. That nervous system must be fairly complex to convert the specific data of the bat's squeaks into a flight response.

Considering this system, once again we see the irrationality of evolutionists' claims regarding evolution over the course of time. The theory maintains that living things emerge only as the result of random changes. Yet the moth's auditory system possesses irreducible complexity. In other words, its hearing system can function only if all its components work as a whole. The absence of just one component



or its failure to function properly means that the entire system will be useless. Therefore, the evolutionists' concept of "chance" has no validity.

Most of the systems and organs in living things possess this



same feature of irreducible complexity. Darwin himself realized that this dealt his theory a clear blow. In his book "The Origin of Species", he makes the following admission:

If it could be demonstrated that any complex organ existed, which could not possibly have been formed by numerous, successive, slight modifications, my theory would absolutely break down.<sup>27</sup>

Since modern-day technology has revealed the complexity of the systems in living things, the theory of evolution has collapsed. Darwin arrived at his theory under exceedingly primitive scientific conditions. The lack of technical equipment and knowledge—and thus, the narrow viewpoint—of the time can clearly be seen in all of the theory of evolution's claims. In the 21<sup>st</sup> century, scientific progress has moved on to reveal the perfect structures in living things. Yet there are still people who insist on defending Darwinism.

The superior design in living things proves that they did not emerge by chance but were created with intelligence. Almighty God created all animate and inanimate entities, at a single moment and in the most flawless manner. Those who insist on defending Darwinism would profit from considering the following verse:

**Say: "Can any of your partner-deities guide to the truth?" Say: "God guides to the truth. Who has more right to be followed – He Who guides to the truth, or he who cannot guide unless he is guided? What is the matter with you? How do you reach your judgment?" (Surah Yunus: 35)**





## **Evolutionists' Grave Errors Regarding Moths**

*Some scientists regard the structure of the moth's ear as "simple." Yet their reason behind that view lies in evolutionist preconceptions and has no scientific foundation. Animals with a central nervous system (including human beings) perceive the outside world by means of a series of sense organs connected to the brain by nerve fibers. The moth perceives it by means of a few nerve fibers only. Therefore, according to the evolutionists' view the moth's hearing system is more primitive and thus, stands on the lowest rungs of evolutionary development. As with all their other claims, evolutionists have fallen into a grave error in regarding this system as primitive.*

*If a function meets its needs fully within a small space, with as few components as possible, that is a result of advanced development. As technology develops, mobile phones and radios are growing ever smaller, and their components becoming fewer in number and working much more efficiently.*

*The system in moths works with very few components, yet moths can make sound measurements with their ears that human beings make only with technological equipment. Such a system cannot come about "in stages" because none of the intermediate phases can work by itself. Describing this ability as "primitive" is yet another fruitless effort to ignore the existence of God.*

*Twenty-first century science, having studied life down to its finest details, has shown that most structures in living things are so complex that they could not have arisen through a large number of small changes. In order for such flawless systems to exist at all, the existence of a Creator possessed of most superior knowledge is essential. The incomparable designs in living things belong to God, the Lord of All. His creative power and artistry is described thus in one verse:*

***He is God – the Creator, the Maker, the Giver of Form. To Him belong the Most Beautiful Names. Everything in the heavens and Earth glorifies Him. He is the Almighty, the All-Wise. (Surat al-Hashr: 24)***

## THE HEAT DETECTION SYSTEM IN SNAKES



The facial cavities on the front of the rattlesnake's head contains heat sensors that the snake uses to detect infrared rays given off in the form

of body heat by warm-blooded birds and mammals nearby. Those sensors

are so sensitive that they can identify an environmental temperature rise of  $1/300^{\text{th}}$  of a degree, in just  $35/000^{\text{th}}$  of a second. The rattler can follow prey that has moved away from it simply by detecting the heat given off by its footprints.

Nor does its sensitive heat-detection system serve only to find prey. The snake is a cold-blooded reptile that can maintain its vital functions only when the ambient temperature is higher than 30 degrees. For that reason, its heat sensors are a great help in finding warm caves or tree trunks where the snake can hibernate over the winter. Of the fourteen species of snake only two have heat sensors, and there are differences in the sensors between these two species. Vipers, for example, bear their sensors on the front of the head under their eyes.



Each cavity is a few millimeters in diameter and up to 5 mm (0.1 inch) deep. Its interior is divided in half by a membrane, forming what's called the inner and outer chambers. In the snake's skull are two trigeminal nerve branches that terminate towards the membrane. The heat given off by the prey's body is turned into electrical signals, and the trigeminal nerve serves to transmit these signals to the part of the brain known as the terminus.

As the nerve branch nears this region, it begins to lose its special sheath. At the end, it takes on a wide, dispersed structure ending in tiny cell-like entities called mitochondria. When the heat stimulus reaches them, it undergoes a structural change, thanks to which the snake detects its prey. It is not yet fully understood how this detection system actually works, though scientists commonly view that it takes place through a very special complex process.<sup>28</sup>

#### • **The Importance of Control in the Heat Detection System**

The snake's heat detection system operates independently of its own body heat. It is activated as soon as the signal is received, but does not react afterwards.<sup>29</sup> This feature alone is enough to show that rattlesnakes' system is the product of a specially designed plan. If these sensors reacted to the heat given off by the snakes own body, they would constantly emit signals obscuring those from outside heat sources, and the system would be useless.

But this does not occur, because God created rattlesnakes together with their sophisticated infra-red detection.

Every single detail in this sensory system, unique to snakes, is flawless. Every stage has been perfectly designed, right down to the finest detail.

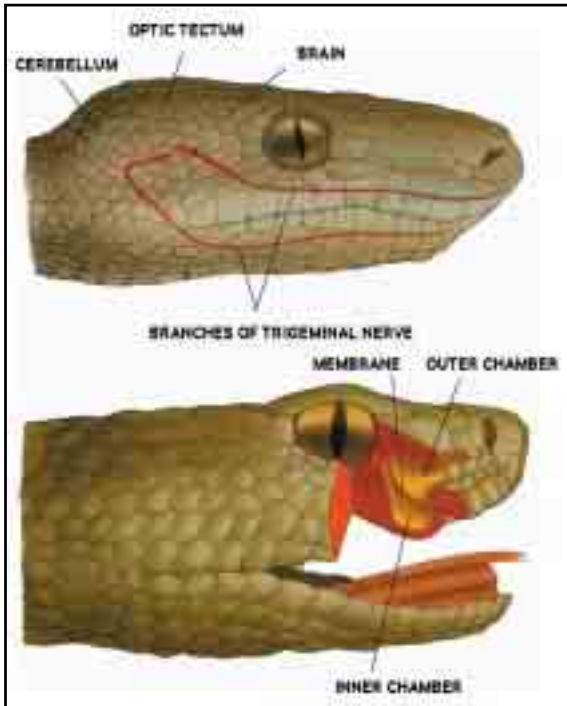

*These illustrations show the anatomy of the boa constrictor's heat detectors. Behind the scales on the upper and lower jaw is a detailed nerve network, which constitutes a two-part system. When it encounters an infra-red stimulus, it sends a trigeminal signal to the brain—where a reaction has been recorded only 35 milliseconds after the snake's detecting a small level of infra-red radiation.*

It is obvious that chance can never come up with such a system in a great number of stages. No other power than God can create such perfect systems, especially not in all the other members of the species. Let's demonstrate this manifest truth once again by examining some other systems in snakes.

#### • **Hunting Mechanisms in Snakes**

With the help of its forked tongue, a snake can detect if its prey has stopped and has crouched down on the ground, motionless, half a meter in front of it. Despite the pitch dark, its heat detection system accurately locates its prey. First it creeps silently forward until it reaches the attack distance, then rears back its head and leaps onto its



victim like a spring. By this time it has already sunk its fangs, in its jaw that can open up to 180 degrees, into its prey. All this takes place at a speed equivalent to a car reaching 90 km/hour (55 mile/hour) in half a second.

In incapacitating its prey, the snake's most important weapon are its poison fangs, which can be as long as 4 cm (1.5 inches). These are hollow, connected to a venom gland whose muscles contract when the snake bites to inject the venom under high pressure—from the fang's canal to under the skin of the victim. Snake venom either paralyses the victim's central nervous system, or else kills it by congealing its blood.

• **How Do Snakes Tell Whether a Heat -Emitting Body is Prey or Not?**

An experiment determined that the snake identifies whether a source of heat represents genuine prey by its heat sensors and forked tongue working together. In total darkness, a hot sandbag and a dead animal were left out in front of a snake, who first moved towards the sandbag, but did not try to swallow it. Although the dead animal emitted no heat, the snake examined it with its tongue when it came across it, and then began eating it. These two sensory systems have been created with features that complement one another. Were that not so, the snake would waste its time in attacking every heat source it encountered.

It is astonishingly apt that the snakes' night vision system should be able to establish another animal's location accurately and that it should have the equipment necessary to kill it with venom.

Of course, those who deny the existence of God can't explain how

Engineering in Nature





the snake has a poison system in its jaw that's most complex and specially planned. For the system to function at all, the fangs first need to be hollow, then the venom glands connected to them, and the venom itself must be powerful enough to quickly paralyze its prey.

Furthermore, the system must operate by reflex the moment the snake bites its prey. The absence of just one of these many components will mean that the whole system cannot function. This could result in the snake falling prey to the very animal it had selected as prey.

Another detail needing additional consideration is the way the venom the snake's body contains doesn't harm the snake itself. The glands that store the venom need to have a protective feature to keep it from spreading through the body, killing the snake. The venom system, which exists as a composite whole, clearly cannot have arisen in stages via an imaginary process of "evolution."

Just thinking about the venom system is sufficient to reveal the laughable nature of evolutionists' claims of "chance emergence," because as you can see from the examples just cited, everything in the snake's bodily systems is exceedingly complex and inter-related. Heat sensors or poison fangs evidently cannot appear one day by some mutation. In a crude description of the stages that would have to take place, the fangs would need to appear first, before the hollow passages inside them. Then the snake's body would have to "learn" what formula of venom affects warm-blooded animals; and then the snake would have to produce venom inside its own body. Everything, right down to the smallest details, is flawlessly arranged. God, the Omnipotent, created rattlers with their perfect scent detection abilities, poison systems and all their other attributes. In the Qur'an, those who refuse to have faith are described by God as cruel

Engineering in Nature



1. The rattlesnake can strike at its prey at a speed comparable to that of a late-model sportscar.



2. The heat detectors on the front of the snake's head work like thermal cameras. Thanks to these detectors, the animal can "see" around it in nocturnal darkness.

3. The snake's venom is so powerful that one drop of it could kill dozens of animals. The glands that synthesize this venom use a technique superior to those in modern laboratories.

4. The rattle at the end of the snake's tail serves as an alarm to warn off enemies.

5. The hollow fangs that pump the venom into the prey have a special injection system.





Harun Yahya

and He goes on to reveal:

Who could do greater wrong than someone who is reminded of the signs of his Lord and then turns away from them, forgetting all that he has done before? We have placed covers on their hearts, preventing them from understanding it, and heaviness in their ears. Though you call them to guidance, they will nonetheless never be guided. (Surat al-Kahf: 57)

### **THE SCORPION'S SENSORY ABILITIES**

Desert-dwelling sand scorpions are some of the most dangerous small arachnids. This species of scorpion is almost blind, yet it expertly locates its prey at night. How is this surprising skill possible?

Adnan Oktar

The answer is linked to the cleft-shaped sensors on its eight feet, which are so sensitive that they can detect vibrations smaller than one millionth of a millimeter.

Let us imagine that a butterfly lands somewhere near a scorpion, setting up two types of vibrational waves in the ground. The first type are so-called volume waves and move faster than 150 meters a second (492 feet/second). The second, known as Rayleigh waves, travel parallel to the surface at more than 50 meters a second (164 feet/second). The scorpion determines the distance to its prey by analyzing the difference between the times at which the two waves arrive.<sup>30</sup>

Of course, knowing the prey's distance still doesn't establish its exact location. The scorpion must also determine the prey's direction.

The scorpion's legs stand on the ground in a circle approximately 5 cm in diameter. That makes for a difference as small as 5 milliseconds (1/200th of a second) between the arrival of the Rayleigh wave from



*For millions of years, the desert scorpion has been able to detect the slightest vibration on the surface of the sand. Human beings have been able to make vibration detectors only after long years of accumulated knowledge.*



the prey at the nearest scorpion's foot and its arrival at the foot furthest away. When the sensors' nerve cells detects a Rayleigh wave, one of the cells transmits a signal to the central nervous system, as well as to the nerve that perceives the waves from the three opposite legs with a slight delay. However, the signal from those three legs is suppressed, and does not immediately reach the nervous system center.

In this way, the creature can analyze the position of the foot that constitutes the source of the earliest signal and those of the other three feet. By this positional analysis, it establishes the direction of the source of the wave.

Should the difference between the warning signal and the suppressed signals reaching the sensors in the feet be less than 1/500th of a second, then the nervous system perceives both signals at the same time, with no delay. For the scorpion this means going into action and using all its perfectly designed weapons for the attack.

The eight nerve cells that process the signals from the feet make a joint decision, just like a committee, on the direction of the prey.<sup>31</sup>

How does this happen? Do the nerve cells hold a meeting every single time, set out the data and arrive at a conclusion?

Obviously, there is no such meeting. Nerve cells consist of nothing but protein, fat and water, with no reason or consciousness.

This mechanism has operated exactly the same in all the scorpions that have lived over millions of years. It did not develop by chance over time, as evolutionists would have us believe, nor was it added on afterwards. Almighty God created the scorpion with its perfect design.

Engineering in Nature





Harun Yahya



#### **1- THE LUNGS**

*Scorpions have eight breathing holes in their abdomens and can breathe without difficulty if just one of these is open. Thanks to its powerful book lungs, it can stay underwater for up to two days.*

#### **2- A POWERFUL ARMOR**

*The shell surrounding the scorpion's body is so strong that it can protect the scorpion like a suit of armor—not only against enemies, but also against radiation. The resistance to radiation of the human body is around 600 rads. The scorpion's resistance ranges between 40,000 and 150,000 rads.*

#### **3- A POISON SPEAR**

*Scorpions inject their venom, sometimes powerful enough to kill a human being, by means of the sting at the end of their curved tail.*

#### **4- PINCERS**

*The scorpion immobilizes its victim with its pincers before stinging it. It also uses them to dig into the sand and conceal itself.*

#### **5- THE BRAIN**

*The scorpion's brain structure consists of 15 nerve nodes extending down to its tail. This structure gives the animal the advantage of fast reflexes and the ability to make swift decisions. The necessary commands reach its extremities very quickly.*

#### **6- THE FEET**

*The sensors on its feet are so sensitive that the scorpion can perceive all forms of vibration, sound and movement. It can detect vibrations in the sand caused by a living thing nearby in the extraordinary time frame of 1/1000th of a second.*







*Chapter Three*

**Physical Engineers  
With An Expert  
Knowledge of Optics**





# H

ow does a tiny ant find its way in the desert wastes? How do butterflies regulate their body temperatures? How does a fish see above the surface of the water? In addition, how does it go even further and calculate the angle of refraction in such a way as to catch an insect above the water's surface?

One common feature of all these creatures is that their behavior requires expertise in the field of optics. As we'll be seeing in some detail, some butterfly species warm their bodies by using the same rules of optics employed by physicists. Another example is the four-eyed fish anableps, whose optic design gives it an advantage both in an atmospheric and an aquatic environment.

When we examine these systems and intelligent behaviors, all the products of a special design, it emerges that by itself, a butterfly or an ant can't possibly establish such systems in its body much less know how to use them. All living things emerged in a moment, together with all the features they possess and the knowledge of how to employ them. God has created them all in the most beautiful form.

## **BUTTERFLIES THAT KNOW THE LAWS OF OPTICS**

Physicists use three basic principles in optics:

A surface warms up more as the light rays striking it approach 90 degrees.

If two surfaces receive light at the same angle, the darker one will warm up more.

When light strikes a reflective surface, it's reflected at the same angle as it arrived.

Although students of physics know these laws, many people today are unaware of their effects on daily life and the purposes they serve. What is surprising, however, is that there are other creatures that put these principles to good use.

In their daily lives, butterflies make use of these laws, of which many humans are ignorant. For example, the *Colias* butterfly is unable to fly when its body temperature drops below  $28^{\circ}\text{C}$  ( $83^{\circ}\text{F}$ ). In that event, it immediately spreads out its wings and, turning its back to the Sun, adjusts them perpendicular to its rays. When its internal temperature rises to a sufficient  $40^{\circ}\text{C}$  ( $104^{\circ}\text{F}$ ), it turns around 90 degrees, which minimizes the warming effect of the Sun's rays, and the butterfly's body temperature starts to fall.

On its wings, this species of butterfly has black spots that also serve to collect heat in the butterfly's body.<sup>32</sup> Significantly, these spots are located near those regions of the body which most need to be warmed, so that the heat is transferred over a shorter distance.

On the other hand, the *Pieris* species of butterfly arranges its wings at such an angle that, just like with a reflector, it can concentrate all the heat rays onto those regions most in need of warmth.<sup>33</sup>

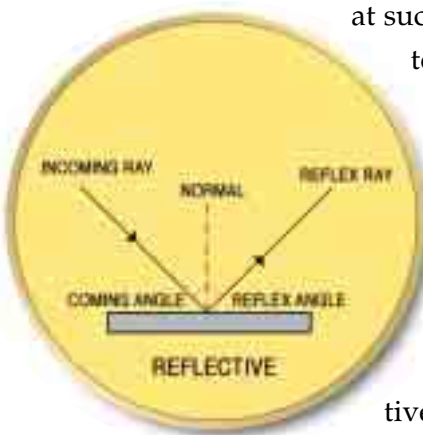

These butterflies have certainly received no training in physics or optics. They are unaware of the laws of physics and of the angle at which solar rays can be most productive.



Harun Yahya

It is God, the protector and observer of all, Who inspires these creatures with what they need to do to warm themselves in the most productive manner. It is revealed in a verse that Our Lord has dominion over all:

**Everything in the heavens and everything in the Earth belongs to Him. God is the Rich Beyond Need, the Praiseworthy. (Surat al-Hajj: 64)**

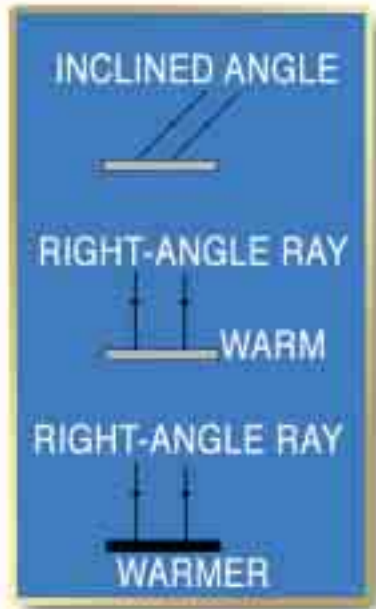

Adnan Oktar

Engineering in Nature

*Butterflies of the genus Pieris arrange their wings at an angle to collect the Sun's rays in the regions of their bodies most in need of warmth. This form of behavior requires a knowledge of optics. Human beings use mirrors and lenses to focus rays onto a narrow area, as these butterflies do.*

*The only reason for Pieris butterflies being capable of something that requires optical knowledge: God inspires these insects with knowledge of how to warm themselves in the most efficient way.*





*"Rays I and II arrive in such a way as to form a particular angle to the horizontal, in the manner shown. In order for these rays to intersect at point A, you need to install two reflectors. At what angle to the horizontal do these reflectors need to be, in order for the rays to intersect at point A?" Every day, Pieris butterflies solve a problem like this, of the kind you might expect to find in university exams. They accurately calculate these angles to make the maximum use of the Sun's light. These butterflies have never been taught by any physics teacher, but are able to perform this calculation thanks to the inspiration of God, the Omniscient.*

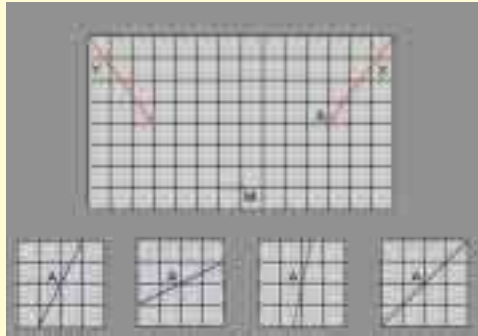

### **MAGNIFICENT OPTICAL DESIGN IN THE FOUR-EYED FISH**

When swimming underwater, everything around you appears blurred. That's because water represents a very different environment for our eyes, which have been created to be able to see in an atmospheric environment. Accordingly, a fish taken out of its normal habitat into an atmospheric environment might also be expected to see everything as blurred. However, one species of fish, which lives in rivers and lakes from Southern Mexico to northern South America, can see very well both in the water and above. This is the anableps, better known as the four-eyed fish. Not only able to see very clearly outside the water, this fish can even focus on objects in the air.

The anableps actually has only two eyes, but each is divided horizontally; that is, each eye has two separate optical systems, each with its own focal length. This flawless design explains why the anableps see two different images at the same time. When swimming slightly

beneath the surface its pupils remain above the surface of the water and constantly scan the air. In this way the fish is able to feed on flying creatures or flee swimming ones.

The two separate focal points in the fish's eye let it receive two images at the same time.

A spotted band of tissue containing pigment and each of the visible irises divide each eye into two halves at the water line, and these form two pupils, one above the water and the other beneath it. Looked at from above, the irises resemble fingers floating in the air inside protuberant eyes.<sup>34</sup>

The four-eyed fish is able to leap into the air to catch insects and to dive into the water to hunt swimming creatures. However, it mainly catches crustaceans moving in the shallow water near the shore, algae, or insects trapped on the water's surface.

Scientists have established that the fish pays more attention to the air, where it can perceive objects that are smaller and more distant. Even so, it frequently dives down into the water to feed or to escape predators.

• **How Did This System Come Into Being?**

It's no doubt that it is impossible for a fish to design two different visual optical systems for itself, according to the different optical properties of air and water, and then to install both systems so that they can work in harmony within a single eye.

Could its eyes have come into being by random processes, as the theory of evolution maintains? In other words, could this optical design—the likes of which is found nowhere else—have appeared by chance mutation in one individual's eyes, and then have been transmitted to subsequent generations?





*When these fish are together, a most fascinating picture emerges. Hundreds of anableps (four-eyed fish) waiting in the tidal region at the mouth of the Surinam River look out of the water all at the same moment. When the waters retract, the fish will throw themselves onto the food-rich mud. When they perceive approaching danger, such as a low-flying bird or large fish-eating animal, they immediately retreat back into deeper water.*

Of course not. Complex structures such as eyes depend on a great many inter-related components working together. The absence of or a defect in any one will mean the eye serves no purpose at all. Systems like this are known as "irreducibly complex." For example, the human eye cannot be reduced to any simpler form, since without every single one of its features, it can serve no function at all. This is further proof that the eye couldn't have "evolved" in stages over the course of time.

As Darwin himself admitted, "If it could be demonstrated that any complex organ existed, which could not possibly have been formed by numerous, successive, slight modifications, my theory would absolutely break down."<sup>35</sup> This single example undermines the very foundations of his theory of evolution.

Darwin was aware that he faced a grave dilemma with regard to the "evolution of the eye." Indeed, he confessed this in the chapter of



his book called *Difficulties on Theory*. The American physicist H. S. Lipson, who read Darwin's book, made the following comment about these "difficulties" of Darwin's:

On reading *The Origin of Species*, I found that Darwin was much less sure himself than he is often represented to be; the chapter entitled

"Difficulties of the Theory" for example, shows considerable self-doubt. As a physicist, I was particularly intrigued by his comments on how the eye would have arisen.<sup>36</sup>

Since evolutionists can't account for the emergence of a single eye, they obviously can offer no explanation of the origin of the four-eyed fish, which can see as well as a human being above the water, but as well as a fish underneath it. The four-eyed fish, has been created by God, with an extraordinary system, using no previous models, and utterly flawlessly.

Evolutionists refuse to see this obvious truth and still insist on believing in nonsense, but everyone else should determinedly avoid falling into the same error.

This deep lack of understanding is given to them in return for their rejection of the existence of God. In one verse God reveals:

**Do not be like those who forgot God so He made them forget themselves. Such people are the deviators. (Surat al-Hashr: 19)**

Since the refraction indices of water and the eye's cornea are nearly



the same, light reflected from underwater objects passes directly through the cornea and is focused in the lens, which has a higher index. Air, on the other hand, has a lower refractive index than the cornea, for which reason the light is refracted twice. The anableps sees both images clearly by using its flawless, egg-like lenses. The section of the lens at the same level as the pupil has been given a spherical shape, just like a fish's eye. A swimming insect larva can thus be focused onto the retina. The less rounded upper part, on the other hand, more closely resembles the human eye and compensates for the two refractions that take place when looking at objects in the air. The fish can thus see even a mosquito perfectly clearly. This perfect design is just one of the countless examples of God's incomparable creative artistry.

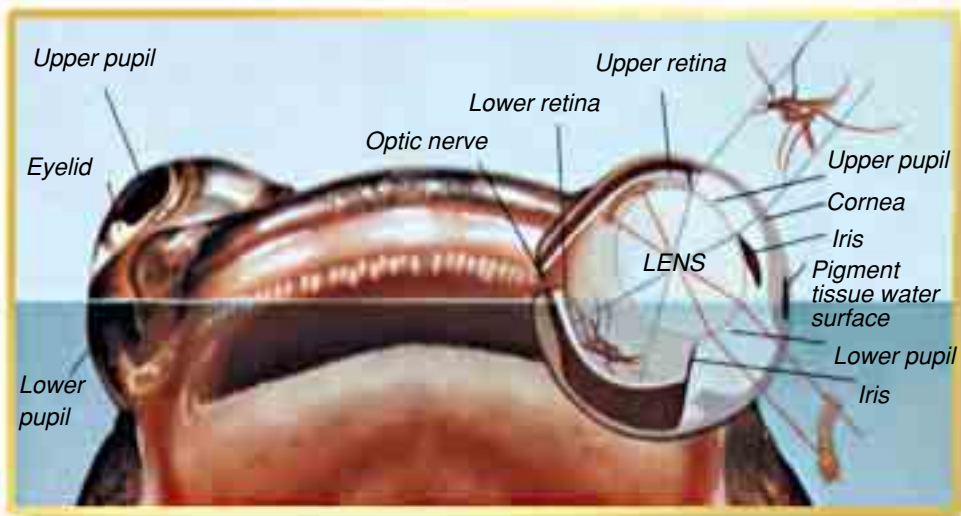

*This shows how a four-eyed fish sees in environments with different refractive properties, such as water and air.*

## THE COMPASS IN THE ANT'S EYE

We need a map to show us where we are, and a compass to tell us which direction to take. But the black desert ant, which lives along the Mediterranean coast of Tunisia Mahares, can find its way without using either device.

When the Sun rises, the ant leaves the nest to search for food in the desert sands, whose temperatures can rise as high as 70 °C (158°F).



The ant follows a meandering course in an area extending up to 200 meters (650 feet) from its nest, frequently stopping and turning around. Yet despite all these complex zigzags, upon finding food, it follows a straight line back to its nest.

Compared to its own size, this journey the ant undertakes is equivalent to a human being walking 35 to 40 km (21 to 24 miles) in the desert and then returning to his starting point, without neither map nor compass.<sup>37</sup>

The magnitude of this accomplishment can be better understood by bearing in mind the scarcity of signs in the desert to help the ant find its way. It would be yet another miracle for the ant to remember the landmarks it saw on its wanderings and then find its way by searching them out.

Yet the direction-finding system placed in its eyes by God is far su-



perior to either map or compass. The desert ant is able to polarize light—one feature lacking in the human eye. During this process it perceives certain rays that are invisible to us and, using them, can distinguish north and south every time it looks around. It thus always estimates the direction in which its nest lies and has no difficulty in returning to it. How can one account for an ant knowing about polarized light, something that humans discovered only recently, and using it like a compass? It is of course impossible for the ant to know all of this by itself.



Again, it's impossible to account for this ant's complex eye structure in terms of random coincidences. Ever since their first days on Earth, all desert ants have possessed eyes with exactly the same properties—the gift of their Creator, Who created us and all other living things. In one verse it is revealed:

**He is Lord of the heavens and the Earth and everything in between them, so worship Him and persevere in His worship. Do you know of any other with His Name? (Surah Maryam: 65)**

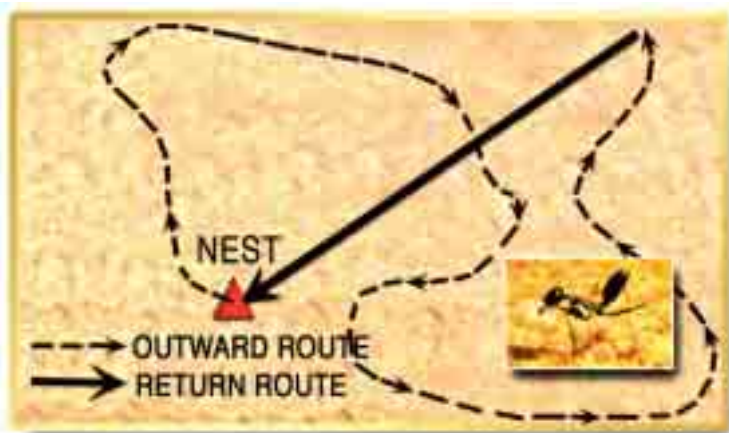

*Chapter Four*

**Mechanical Experts  
in Nature**

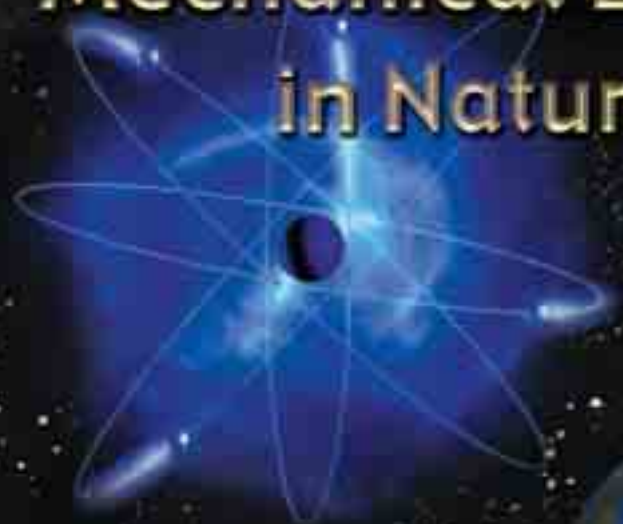



Z

n the bodies of living things, there are a great many inter-related mechanical designs: the detailed structure of tiny hairs that cause cells, invisible to the naked eye, to clear the respiratory tract; the special systems that allow fragile moths to survive in deadly cold; and the power in its feet that allows the gecko lizard to climb up sheer walls and even walk on ceilings.

Once again, chance could never bring such flawless structures into being.

The structures, adapted to living things' environments, and the intelligent behavior they exhibit show us the magnificent artistry of God, Who knows all forms of creation.

### **THE HEATING SYSTEM IN WINTER MOTHS**

Winters are harsh in Central Asia, Siberia and Northern Europe. Lack of food and bitter cold cause the deaths of many living things. Yet despite the appalling weather conditions, a few manage to survive. One of the most astonishing is, without doubt, a delicate moth.

The answer to how these fragile creatures manage to survive lies in their bodies' perfect heating system.



## **Resilient Winter Moths**

A great many species of moth die in winter. Yet some manage to survive—for example, the 50 or so species of the Cuculinae sub-group of the moth family Noctuidae are able to survive through even the harsher months of the winter. For that reason, Cuculinae moths are also known as "winter moths," which have a life cycle the exact opposite of other members of their species. Their caterpillars feed on tree seeds in early spring and then remain motionless throughout the summer. They grow to adulthood at the end of autumn or in the winter. And during the cold days of winter, they feed, mate and lay eggs for subsequent generations.

Scientists studying the winter moth's interesting life cycle came up with surprising and thought-provoking conclusions.

First of all, to survive these creatures need to fly. Yet in order to do so, the temperature of the thorax region where their wing muscles are located must be at least 30°C. Where the moths live, however, the ambient temperature is generally below freezing.

Scientists therefore began seeking to answer how winter moths survive despite the cold. How is it that they don't freeze when they are motionless? Despite the cold, how do they manage to fly, feed and reproduce?

Researching all these questions, scientists discovered that winter moths have a marvelously engineered heating system. This system, the product of the most delicate planning and superior creation, is an assemblage of complementary stages.

### **Stage 1: Heating by Shivering Their Wings**

In the winter moth's body, the main muscles are connected to the wings. Before flight, the moths shiver their wings by constantly contracting these muscles, causing the temperature of their thorax region



Harun Yahya



to rise, from 0°C to 30°C (32 °F to 86°F) or even more.

The muscles' vibration takes place in connection with the moth's nervous system, which is able to go into action in low temperatures. In order to understand the importance of this superior feature, it's enough to remember how difficult it is to start your car's engine on a cold, snowy day.

Winter moths begin shivering the moment they determine that the air temperature has neared 0 degrees (32°F). Under certain circumstances, they start shivering at colder temperatures, such as -2 degrees (28°F). But after more than half an hour of wing movement,

Adnan Oktar

they achieve the requisite temperature for flight.<sup>38</sup>

At first scientists assumed that this success stemmed from the moths' metabolisms and carried out research in that area. To that end, they measured the winter moth's metabolic rates at rest, during shivering, and in flight. Yet the figures they obtained were roughly the same as those for other species of moth, of the same weight. It was thus realized that the moths' warming had nothing to do with the speed of their metabolisms. As a result, it emerged that winter moths have a heating system that is unique to this species.

### **Stage 2: Finding a Protective Shelter**

The research into winter moths began with the temperature and humidity of its environment, because the freezing process starts with ice crystals forming in the winter moth's body. In drier environments, the moths' freezing temperature drops to rather low levels. Therefore, how do the moths find a shelter to protect themselves from ice and sudden temperature drops?

Even when the outside air temperature is around  $-30^{\circ}\text{C}$  ( $-22^{\circ}\text{F}$ ), the temperature beneath the leaf layer covering the ground seldom falls below  $-2$  degrees C ( $28^{\circ}\text{F}$ ). When the temperature does plunge below  $-2^{\circ}\text{C}$  ( $28^{\circ}\text{F}$ ), the winter moths conceal themselves under the leaves, which act like a kind of blanket, until the air temperature rises enough to support them again. Whereupon other systems in the moths' bodies go into action to keep them alive.

### **Stage 3: The Natural Anti-Freeze Mechanism in Winter Moths**

To stop the water in our car radiators from turning to ice, we use anti-freeze. But few people know that some living things actually have anti-freeze-like chemicals in their own bodies to protect them



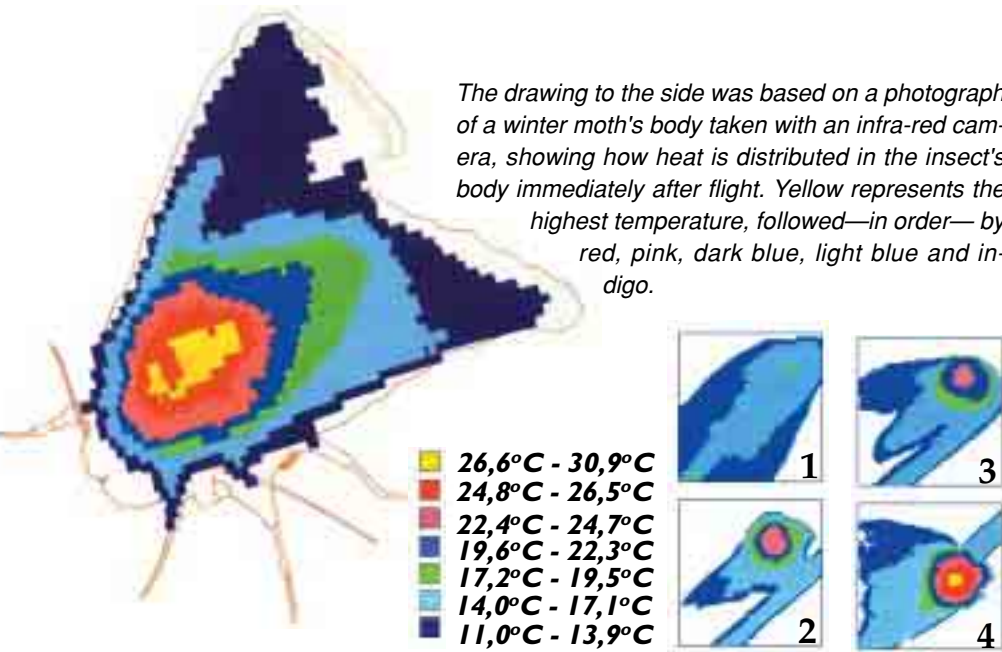

*In cold weather, winter moths warm themselves by beating their wings, contracting all their wing muscles at the same time. The pictures at right show the distribution of heat in a moth beginning to beat its wings, prior to flight. Pictures 1 and 2 represent infra-red photographs taken from above, and 3 and 4 photographs taken from the side.*

from the freezing winter cold, although these natural alcohol-based anti-freezes also have some unwelcome side effects. The most important drawback of these substances is that they are poisonous.

In living bodies, therefore, natural anti-freezes are turned into less poisonous substances as a result of a series of biochemical processes. Yet this is a very slow process. In particular, if the animal's body temperature is low, it will take longer to throw off the lethargy caused by the anti-freeze.

Winter moths are among those animals with anti-freeze mechanisms, yet they use proportionally less of it than other cold-hardy living things.

### **The Specially Regulated Level of Anti-Freeze**

As soon as the air reaches the necessary temperature for flight, the winter moth needs to go into action. Yet in order for its internal anti-freeze to have an effect on the entire insect, it needs to wait for rather a long time. For that reason, the moth's level of anti-freeze is proportionately lower than in other living things.

This amount has been regulated at such levels that when the temperature reaches a danger point, the moth gains enough time to find a warmer location. In experiments at Notre Dame University, John G. Duman established that in moths slowly chilled in an ice-free environment, the freezing point was as low as  $-22^{\circ}\text{C}$  ( $-7.6^{\circ}\text{F}$ ).<sup>39</sup> How did this system in the moths come about? Who determined the anti-freeze formula, and how is its level determined? Why do all winter moths, without exception, have proportionately less anti-freeze than other creatures?

It's impossible for the moth to know the chemical formula for natural anti-freeze, or to produce it in the requisite quantities within its own body. It needs to determine the chemical, eliminate its poisonous effects and possess the engineering knowledge for each individual stage.

The winter moth is no





chemical engineer, but it does all this with ease, setting this system in motion every time the weather grows cold. It receives no help in doing so, reads no books and conducts no experiments. A human being cannot become a chemical engineer all of a sudden, so such a thing is very definitely impossible for a moth. So how did it come by this knowledge?

It is impossible for such a complex system to come about in stages, under the influence of chance, as evolutionists would have us believe. Considering just one of the various reasons will be enough to show how illogical that claim really is.

First and most important, any mistake in the anti-freeze formula will spell death for the moth. It would be lethal for the moth to have as much of this substance in its body as there is in other creatures. Moths use anti-freezes with a specific formula, and they must be pre-



sent in the body in specific amounts. That means that control is essential in its production. It is impossible for just one of the molecules in this formula with such a special function to come into being by chance. Furthermore, there is no possibility of blind chance arranging the production of the molecule in just the requisite amounts, neither too great nor too small.

When the moth encounters cold weather, it can't just await the chance emergence of this substance. Temperatures as low as  $-20^{\circ}\text{C}$  ( $-4^{\circ}\text{F}$ ) will swiftly lead to the death of this delicate creature and the extinction of the entire species.

Therefore, the features of moths alive today must also have been present in the very first moth to come into existence. This all demonstrates that the design in moths is not the result of mindless chance, but of God's flawless creation. As He reveals in one verse:

... God has appointed a measure for all things. (Surat at-Talaq: 3)

#### **Stage 4: Balancing Energy Consumption**

One might think that in cold weather, winter moths would be found in the warmest places possible. Yet that assumption would be wrong, because when seeking shelter, moths behave most intelligently. Indeed, studies have shown that these creatures avoid excessively quiet and warm hiding places, so as to balance their energy consumption.

The amount of energy the winter moth uses when at rest is directly linked to its body temperature. The lower its temperature, the less energy the moth uses up. For that reason, moths prefer environments cold enough to let them expend as little energy as possible, but still warm enough to let them survive. To this end, they use the energy resources in their bodies in a most balanced manner.



Energy metabolism measurements taken from winter moths at rest clearly reveal this equilibrium:

For example, a winter moth that had consumed 6 grams of plant sap and sugar could remain at rest for 193 days at a temperature of  $-3^{\circ}\text{C}$  ( $26.6^{\circ}\text{F}$ ). When the temperature was increased by  $3^{\circ}\text{C}$ , in other words at  $0^{\circ}\text{C}$  ( $32^{\circ}\text{F}$ ), the moth was able to continue for only 24 days. At  $10^{\circ}\text{C}$  ( $50^{\circ}\text{F}$ ), its energy reserves are enough for only 11 days.<sup>40</sup>

That moths make very accurate and rational selections is an important point that needs to be borne in mind.

### **Stage 5: The Special Heat Insulation System in Winter Moths**

It is well known that a heat radiates from warm environments to colder ones. For that reason, the moth's raising its body temperature alone is not enough to let it take flight, because the temperature difference between the moth's warm body and the outside cold will lead to an acceleration of heat loss. For the moth to be able to take flight, therefore, it also needs a means to protect the heat it generates. Its body has again resolved this need with a perfect design.

### **Can the Winter Moth Insulate Its Heat?**

Insulation is the most effective method against cold. In colder climates, buildings are constructed using insulation technologies that reduce heat loss from external facings, windows and roofs to a minimum. In a similar way, moths have an insulating system that minimizes heat loss—a thick, scaly layer that covers their bodies.

Bernd Heinrich, a zoology professor from Vermont University, conducted experiments that established that moths without a scale



**Prof. Bernd Heinrich**

covering grew cold faster than moths with one. He performed an experiment to determine to what extent that layer could retain heat. Moths with their normal protective coverings and others deprived of them were subjected to various wind tunnel speeds. He measured the rates of chilling of the moths' bodies and observed that at a wind speed of 7 meters a second (22 feet/second)—roughly the speed at which a moth flies—moths without protective coverings grew cold twice

as fast as those with their scales intact.<sup>41</sup>

This layer is an important piece of the moths' makeup, yet it is still not enough to meet all the insect's needs. In humid environments, moths can survive only down to  $-2^{\circ}\text{C}$  ( $28^{\circ}\text{F}$ ), which is their standard freezing temperature. But as we've already seen, temperatures where they live can fall to as low as  $-20^{\circ}\text{C}$  ( $-4^{\circ}\text{F}$ ). In such extreme cold, the scaly layer's protective function will of course be insufficient. Therefore, the moth needs an additional system.

From there, scientists began to examine of the winter moth's heating systems in greater detail.

### **Another Proof of Flawless Design**

When the air temperature during flight falls below zero, the winter moth has to overcome yet another problem. The moth will vibrate its wings to maintain heat in its thorax, since the emerging heat will be lost in due course, the moth won't be able to maintain the required heat level. It will thus expend all its energy on vibration, and then die. But contrary to this likely scenario, the winter moth stays alive be-



cause the perfectly designed system in its body overcome every difficulty.

This system prevents heat being dissipated to colder regions outside the thorax, serving as an ideal means of insulation in protecting the moth's internal heat.

George R. Silver, of the US Army Research Institute of Environmental Medicine in Massachusetts, conducted a series of studies on the subject. He used an infra-red camera to photograph these insects and observe the amount of heat they gave off. His pictures showed that during warming, flight and post-flight cooling, the winter moth's legs, wings and stomach regions warmed up very little or not at all.

Silver's research also revealed another miracle mechanism in the winter moth: an insulation system that delays the flow of heat to the head and stomach regions and totally prevents heat transfer to extremities like the legs and wings. Thanks to this design, preventing



*The winter moth's auditory organ lies inside its air sacs, which work as perfect heat insulators. One can compare the sacs to double-glazing on windows, since these sacs prevent a transfer of heat between the external and internal environments, thus forming a kind of insulation wall between the warm chest region and the colder abdomen.*

the dissipation of heat to colder regions of the body, the moth maintains its vitally important thorax warmth.

But at this point arises an important question. The stomach temperature of a moth that takes flight as a result of vibration registers a 2-degree rise, and the rise in thorax heat reaches 35°C (95°F).

How is it, therefore, that this insulation system can maintain a more than 30-degree temperature difference between the thorax and abdomen, which are only 1 to 2 millimeters (0.03 to 0.07 inches) apart from one another?

The answer lies in another amazing design in the moth's circulation system.

### **Winter Moths' Different Body Structures**

In all moths, the blood flows in a single vein from the abdomen to the thorax, and from there to the head, where it is warmed. On its return, it is filtered through tissue. In addition, the anatomy of the winter moth is different from that of summer-flying moths—a difference in design that lets the winter moth survive cold temperatures.

The veins extending along the winter moth's abdomen form the heart-and-aorta section of the circulatory system. This part, which extends in the upper part of the tail, turns a 90 degree angle downwards as it nears the heart region. It then enters this area from underneath where the thorax joins the abdomen. So far, the blood in this area is cold.

When the vein enters the abdomen, contraction of the muscles there warms the blood on its way from the stomach to the chest region. Where the abdomen and thorax meet, the vein assumes more or less a V shape. The blood in the left arm of the V is cold, and that in the right arm warmer.

Under normal conditions, the heat of the warm blood rising in the



right arm should pass to the tail area where the cold blood circulates. However, the winter moth is never exposed to such a lethal situation— thanks to its hearing organ, in the exact center of the bend in the V. This organ is one of the examples of the superior design in the heating system. The animal's auditory organ is inside the tympanic air sacs, which function as perfect heat insulators. One can compare the sacs to a double-glazed window. The sacs prevent the passage of heat between the external and internal environment, forming a kind of barrier between the warm thorax area and the cold abdomen.

In conclusion, the tail area cannot leach heat from the stomach area. In addition, the air sacs in the abdomen provide supplementary insulation.

All these features, just one part of the moths' insulation system deal a lethal blow to the theory of evolution's claims of "chance." The emer-

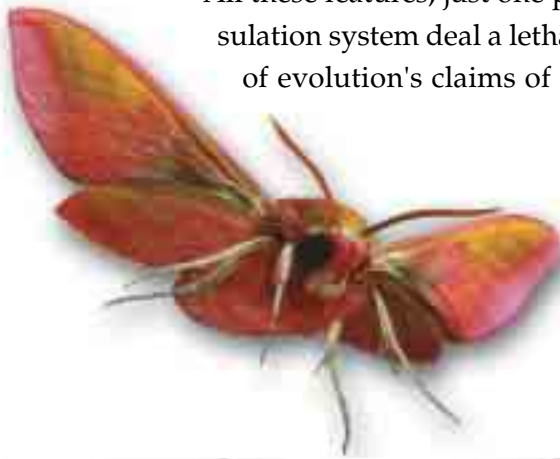

gence of this exceedingly complex system, designed in great detail with flawless engineering and which works in stages, cannot be explained in terms of random mutations. In order for the system to work, it needs to exist together with every one of its components.

To fully provide for the moth's heat insulation, it's essential that its auditory system be in exactly the right place, forming a barrier to keep the requisite regions warmed. If the moth is to gain the time to move, the anti-freeze must be present in the exact right amount with the correct properties. If the moths are to warm up by shivering their wings, their nervous systems and muscles must act at the same time.

None of these systems can possibly be accounted for in terms of chance. These designs in moths are just one of the countless proofs showing how flawlessly God has created living things.

Anyone who sees and thinks about these proofs must live his or her life in a manner pleasing to God, again calling to mind the fact that there is no other deity but Him. God's infinite might and majestic glory are revealed in a verse:

**Everyone in the heavens and Earth belongs to Him. All are submissive to Him. It is He Who originated creation and then regenerates it. That is very easy for Him. His is the most exalted designation in the heavens and the Earth. He is the Almighty, the All-Wise. (Surat ar-Rum: 26-27)**

### **Counter-Current Heat Exchangers in Moths**

When we further examine moths' circulatory system, other astonishing structures appear before us. Cold blood flows from the end of the tail region in the vein that extends as far as immediately beneath the air sacs. That part of the vein just under the air sacs constitutes the bottom end of a V shape, and here it passes through a special tissue.



Heat exchange takes place here, just as in the vein. But although the blood in the vein is cold, that tissue is warmed by blood from the thoracic region.

Theoretically, one should expect a heat transfer from the warmer blood to the cold. In such a transfer, the heat in the thorax will spread to the abdomen by means of the circulatory system, and no matter how much the moth shivers, it will never achieve the temperature high enough for flight. Furthermore, the air sacs will serve no purpose for heat insulation.

Yet none of these unwelcome developments actually takes place, because all the needs essential to the moth's survival have been arranged with a marvel of biological engineering. What permits this regulation is called a counter-current heat exchanger.

In this system, two liquids (or gasses) in two different but touching, or contiguous, channels flow in different directions. If the liquid in one channel is warmer than the liquid of the other, heat will pass from the warmer one to the colder.

In the moth are two counter-current heat exchangers. The first of these is the abdominal heat exchanger. As its name implies, it's located in the abdomen, immediately beneath the air sacs, and there, the cold blood in the vein and the warm blood in the tissue flow in opposite directions.

As the cold blood from the abdomen flows to the thorax, warm blood flows from the thorax to the abdominal region. This flow causes heat to pass from the tissue to the vein, and from there to the thorax. The heat given off from the thorax is thus loaded onto the cold blood entering it. In this way the heat in the thorax is prevented from passing to the abdomen.

The vein leaving the abdominal region enters the thorax, where the thoracic heat exchanger is. The vein enters the thorax under the stomach, then immediately climbs to the upper part of the thorax—in other words to the back. Here it makes a sharp U-turn and heads back under the thorax. Here, the shape of the vein may be compared to a letter *N* whose arms are touching. The part of the thorax that contains this bend in the vein is the heat exchanger. Since the two arms forming the bend in the vein are very close to one another, the temperature difference between them is reduced to a minimum. Thus the temperature in the moth's thorax is perfectly stabilized.

### **The Vein System in Winter Moths**

To better understand the importance of the thoracic heat exchanger, it's useful to compare the winter moth's vein system with that of the sphinx moth, which lives in warmer environments.

Sphinx moths have relatively larger bodies than winter moths and live particularly in tropical regions. Instead of a heat exchanger, these insects have a cooling system in their thoraces. Instead of the *N*-like bend in the vein, the sphinx has one more resembling a small letter *r*. As can be seen from the diagram overleaf, the left side of the vein bend is longer in the sphinx moth than that in the winter moth. This leads to a temperature difference between the left and right arms of the bend, and for that reason, this part of the sphinx moth's circulatory system is known as its cooling mechanism.

Both sphinx and giant silk moths have a mass 60 times greater than that of winter moths. Therefore, one might expect that they are heated more easily. But contrary to what one might imagine, these moths transmit excess heat first to the head and abdominal region and from there to the air. To state it another way, sphinx moths' cooling system corresponds to the heating mechanism in winter moths. If winter



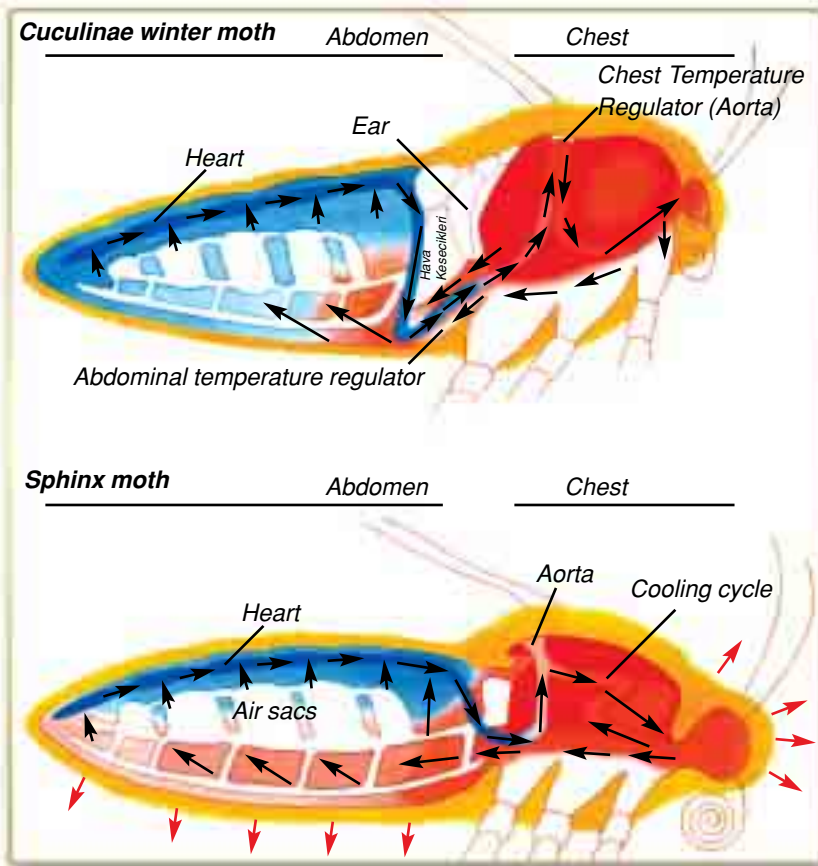

A winter moth (top) is different from a summer moth (bottom). The differences allow the winter moth to survive even in exceedingly cold temperatures. The winter moth's air sacs insulate and protect its chest region, while the design of the insect's circulatory system also conserves the heat in the chest region. The black arrows show the direction in which the blood circulates. In all moths, blood flows through a single vein from the stomach to the chest and from there to the head region. On its return, the blood is filtered through the tissue. The winter moth's circulatory system contains an abdominal and a chest heat counter-current heat exchanger. In the abdominal heat exchanger, blood flowing between the heart and the aorta is cold (depicted in blue). Blood flowing in the opposite direction in contiguous tissue is warmer (shown in red). In this way, heat passes from the tissue to the vein, and from there to the chest (red arrows). The heat exchanger in the chest is the aorta.

moths possessed a cooling system like the sphinx moths', they could never survive. The physical difference between these two species of moth may be compared to the difference in the air-conditioning systems produced for conditions in Arabia and Siberia.

Another species with an anatomy similar to that of the winter moth is the tent caterpillar moth. In this species, the vein bend is in an *N* form, the same as in the winter moth, but the descending branch is not contiguous to the ascending one. This small difference affects the tent caterpillar moth's heat retention ability and allows it to fly only when the weather is warm.

Despite the presence of the same system in both animals' bodies, a small difference gives rise to major changes. Both animals possess bodily structures most ideally suited to the regions they live in—which clearly refutes evolutionists' claims of chance emergence.

According to evolutionists, animals acquired these features by means of blind chances, and one living species developed into another. Just one of the features we've described in moths is sufficient to show how irrational and illogical this claim is.

Random coincidence can never determine the shape assumed by a moth vein. Furthermore, that coincidence would have to have been present in all the winter moths that have ever lived—another aspect that reveals the invalidity of evolutionists' claims.

By itself, no moth can analyze the problems it encounters, deduce solutions to them and adapt its own anatomy accordingly. Moreover, the design in moths constitutes a system in which all possibilities have already been calculated.

No doubt there is a superior Creator Who has created not just the moth but all living things and endowed them with the systems to meet their needs. That Creator is God, Lord of the Worlds.

With the incomparable engineering designs He has created in the



Harun Yahya

body of an insect, God reveals to us the limitlessness of His artistry. God has also commanded us to consider His creations:

**Haven't they looked at the sky above them: how We structured it and made it beautiful and how there are no fissures in it? And the Earth: how We stretched it out and cast firmly embedded mountains onto it and caused luxuriant plants of every kind to grow in it, an instruction and a reminder for every penitent human being. (Surah Qaf: 6-8)**

Everyone who thinks about examples such as these will better understand God's greatness and omnipotence.



Adnan Oktar

## **MICRO-ENGINES IN NATURE**

Some cells in our bodies possess structures that resemble tiny hairs,<sup>42</sup> whose sole function is to move the cells. For example, spermatazoa, the male reproductive cells, use their whips (flagella) to swim. Every cell in the respiratory system has more than a hundred of similar hairs. These hairs move constantly, pushing upwards the mucus in the respiratory channels. Tiny particles that enter the respiratory channels are trapped in the mucus and thus expelled.

Though microscopic in size, these tiny hairs still have exceedingly complex structures.

In cross-section under an electron microscope, they can be seen to consist of nine separate straw-like structures known as micro-tubules, consisting of two separate but interconnected links. The first consists of 13 strands (or protofilaments), with 10 protofilaments comprising the second. The main constituent of micro-tubules is the protein tubulin. Micro-tubules also have an outer and an inner arm containing the protein dynein, which serves as an engine among the cells and provides a mechanical force.

These hairs' only aim is to cause cells—or other substances—to move. In order for this to happen, a very detailed design has been set up. This description is just a brief and simple summary of the design in just one of the components of these micro-hairs. That this perfect structure should have been designed inside an almost infinitesimal cell immediately raises the question of how this design came into being. The rational and flawless planning in the hairs' structure shows us once again that we are faced with a clear miracle of creation.

This detailed artistry in a body too small to be seen with the naked eye is the creation of the all-knowing God. In one verse it is revealed:

**He to Whom the kingdom of the heavens and the Earth belongs.  
He does not have a son and He has no partner in the Kingdom.**



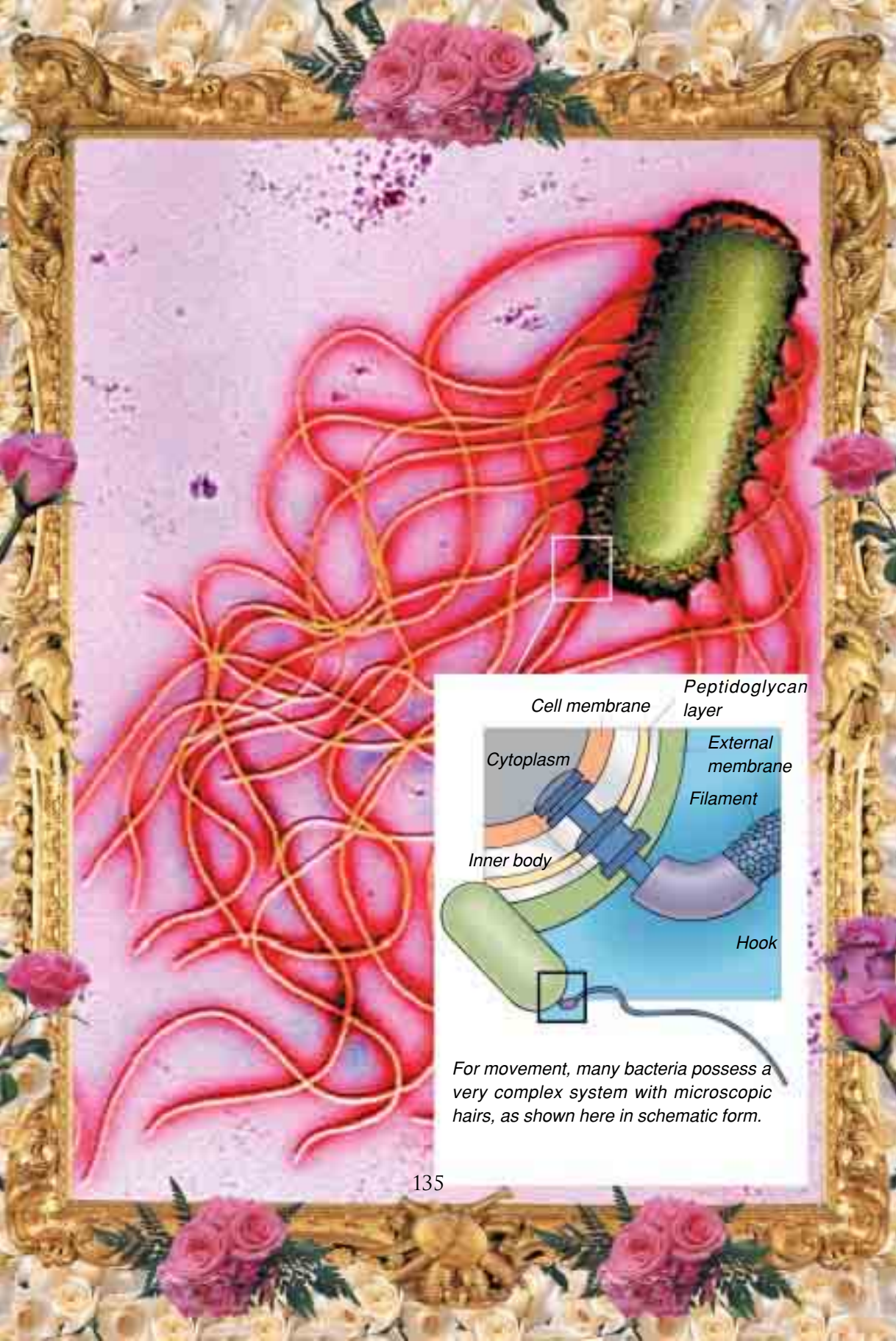

Cell membrane Peptidoglycan layer

Cytoplasm External membrane  
Filament

Inner body

Hook

*For movement, many bacteria possess a very complex system with microscopic hairs, as shown here in schematic form.*

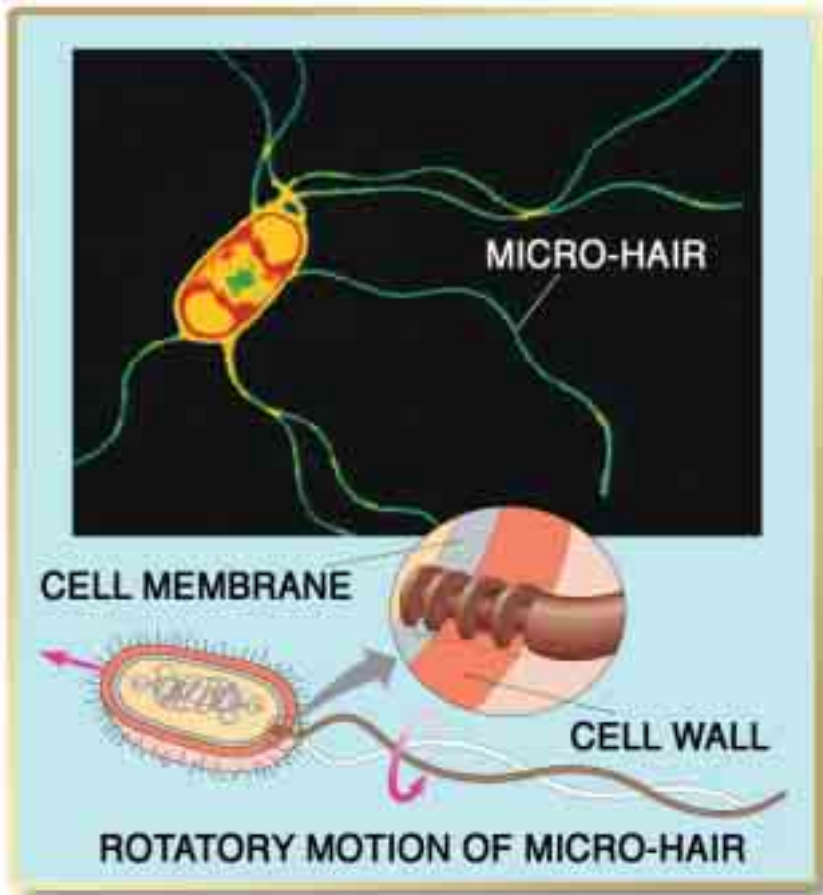

**He created everything and determined it most exactly. (Surat al-Furqan: 2)**

These hairs' structure will be set out in greater detail in the following pages. The purpose is to reveal proofs of God's flawless creation, and to better understand the greatness of our Lord's glory, and the fact that there is no other deity but Him.



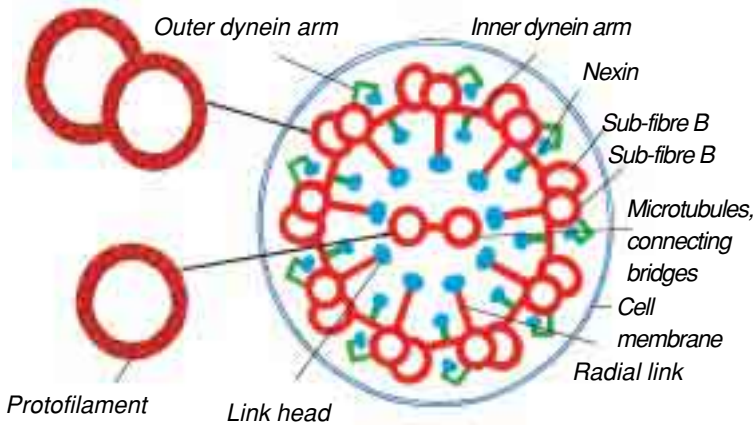

*In cross-section, the tiny hairs are revealed to have a complex structure consisting of inter-connected links. In the center is a micro-tubule consisting of a single connection. Outside are the proteins, and the dynein engine that allows the hair to move.*

### **Design in the Tubulin Molecules**

The structure of the nine separate straws (micro-tubules) making up the micro-hairs is exceedingly systematic. As already stated, the micro-tubules are made up of tubulin proteins. The molecules comprise the tubulin are in the form of cylindrical bricks or beads set on top of one another. But unless cylindrical bodies are attached when piled on top of one another, the slightest pressure is enough to break them apart.

If the surface of one side of the molecule did not match the side of another, they might well suffer such a collapse. Yet that never actually happens, because the tubulin molecules rather resemble food tins, which have small depressions in them that allow tins to be easily stored on top of one another. And even if you knock one of the tins, the rest will not come tumbling down.

Yet tins having the proper design is not enough. If they're placed in such a way that their bottoms face other bottoms and tops face tops,

they'll still fall apart. It calls for planning to arrange them in the right way.

Of course, one tubulin molecule is attached to the next in a far more complex way. There are thousands of different proteins in a cell, and it is essential that the tubulin molecules attach themselves to the right molecules. Were the tubulin molecules to join to just any nearby protein, then the micro-hairs could never come into being.

The more we examine the design of the tubulin molecules, the more complex its structure appears.

In this molecule, there are ten short, needle-like protrusions. At the bottom are ten depressions in which these protrusions sit. A difference in just one of the protrusions would prevent the necessary tubulin connection being made, which definitely proves that each tubulin molecule is created to be compatible with another one.

### **The Connections That Enable the Hairs to Move**

Examination of the cell reveals that like the tubulin molecules, the micro-tubules are attached to one another. However, the connections between the micro-hairs are not in the form of attachments, as is the case with tubulin molecules. Micro-tubules can cling together only with the help of other proteins, and there is an important reason for this.

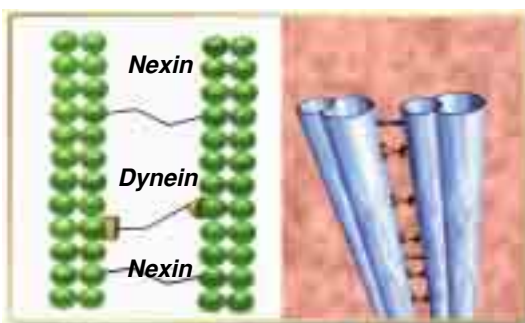

*The movement of the micro-tube is established by the connecting proteins among the molecules comprising the micro-tube. The main element permitting movement is the flexible nexin protein. When it slides over the protein dynein, this will transform into a bending movement.*



Micro-tubules fulfill a great many functions inside the cell, most of which can be performed only when the micro-tubules are separated. Yet as is the case with the hairs, micro-tubules connected together are necessary for some other tasks. Therefore, how do specific proteins join together when necessary?

If micro-tubules had the characteristic of joining themselves together, like the tubulin, they would constantly do so and thus, be unable to perform many of their functions within the cell. Therefore special connectors between the micro-tubules have been created, such as the protein nexin, which connects the end of one micro-tubule, consisting of two conjoined links, to another.

Furthermore, on every micro-tubule are also two separate protrusions made up of the protein dynein, known as the outer and inner arms. Dynein is different to nexin. Its task is to work like a kind of engine and create a mechanical driving force inside the cell. For that reason, nexin

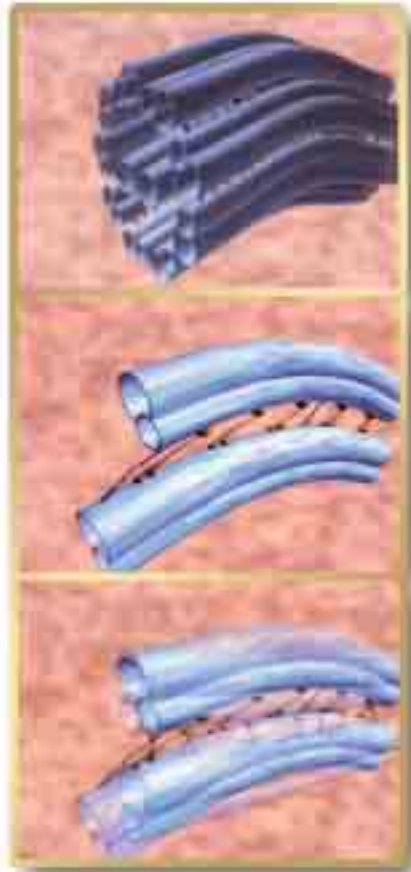

*The top picture shows the micro-tubules in full. Below, how the movement of the dynein and nexin proteins turns into a bending movement, during which the dynein and nexin assume different functions. While the dynein acts like an engine, the nexin helps to keep the structure together. If the nexin and dynein lacked these complementary properties, the tiny hairs would be unable to move.*

and dynein perform different tasks apart from linking the micro-tubules together. (In the micro-hair are other connectors as well as dynein and nexin.) If the proteins dynein and nexin did not have these mutually complementary properties, the hairs could not move.

### **A Microscopically Small Engine**

Another detail makes this interconnected structure even more complex and convoluted. The structure that enables the micro-hairs to move, and which resembles a motor, lies not in the cells to which they belong, but in the micro-hairs themselves. Were just one of the elements in these engines to be absent – the protein dynein, for instance – the hair would be unable to move.

To acquire a better understanding of this structure, scientists set up a model that can be compared to a continuation of the example of the food tins we gave earlier.

Two columns of tins, one on top of the other, are joined by loose wires. A tiny engine is attached to one tin, and a motor arm to the adjacent tin beside it. When the engine is set in motion, the motor arm slides down, pushing down the tube to which it is attached. Since the columns are interconnected, the loose wires begin to contract. As the motor arm pushes the tube opposite it, the tension caused by the wire causes both tubes to lean over to a specific degree. The movement of separation is thus turned into bending.

Let's express this analogy in biochemical terms.

The dynein protein arms between two micro-tubules set the opposite tube in motion. The biological energy known as ATP is used for this movement. When this takes place, the two micro-tubules begin moving together. Were it not for the nexin—in our analogy, the loose wire in between—both tubes would continue to move away from one another. However, the nexin protein's mutual links prevent the micro-



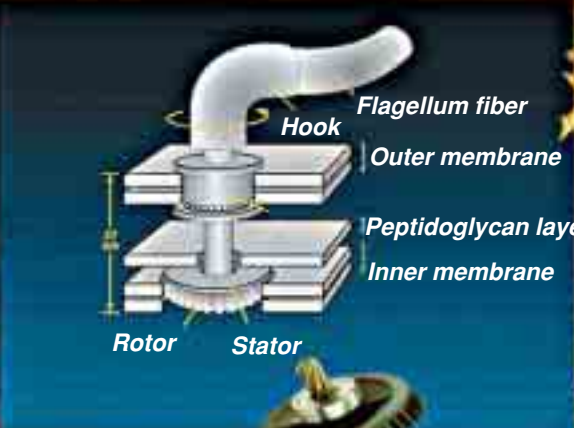
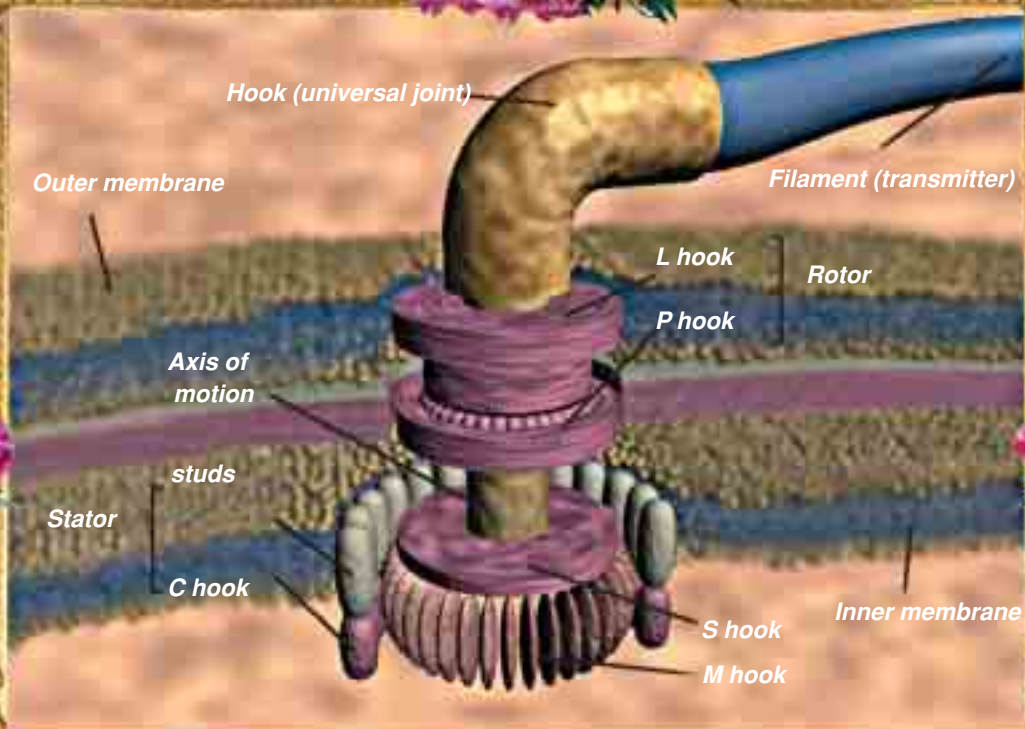

tubule from moving away from its neighboring tubule more than a very short distance. When the loose nexin connectors extend to the final row, the greater movement of the dynein protein makes the nexin connectors to contract from the micro-tubule. The tension rises as the dynein movement continues. Since the micro-tubules are flexible, the sliding movement caused by the dynein protein in the tubule opposite gradually turns into a bending movement.

### **The Micro-Hairs' Mechanical System Cannot Have Formed by Chance**

As we've seen so far, a mechanical system, all of whose parts work interdependently, has been designed in the micro-hairs and is far more difficult than one might imagine. All the elements in the system must be exactly right, and all their features must be fully present, since the slightest deficiency will harm the outcome.

In order to understand this, look at any child's moving toy. If one of the parts that permit it to move is missing, the toy will not work. The absence of just one of its components will reduce it to just a collection of plastic and metal parts that serve no purpose.

To review, these are the parts necessary in order for the micro-hairs to move:

Micro-tubules comprise the main structure of the hairs. They are just as essential as walls are to a building. Were it not for the micro-tubules there would be no part for the engine rod to slide over.

The engine has to be present in order for the hairs, and therefore the micro-tubules, to move.

The links cause neighboring tubules to move. The separation movement is turned into a bending one, and the connectors prevent the entire structure from falling apart.

In order for the system to move successfully, the components'



structure is also of the greatest importance. Any excess or deficiency in these features would cause the system to fail. If the wire connecting the two tubes in question were too weak to bear the tension on it, as soon as the engine went into action, it would break and cause the two tubes to separate. Yet that does not happen: The wires possess all the necessary features, as do the proteins and all the other components.

All this shows the complex perfection in the structures of the micro-hairs. But to better understand the subject, everyone with some basic knowledge needs to ask some questions:

How did these mechanisms come into being inside such a microscopically small area? How did the molecules comprising the hairs acquire these characteristics? How did the hair produce such an incomparable engine system within itself? Could these hairs have evolved in stages, as the result of chance, as evolutionists maintain?

All rational people will appreciate that chance could never bring about the structure of the hairs in the cell for the following reasons:

Since different protein will affect the shape of the cell, it is essential that the proteins attached to the micro-tubules be very specific in order for the hair to be mobile. This situation can be compared to randomly sited cables totally ruining the locations of the joists holding up a building. That reason alone removes any possibility of "chance" development.

The hair has to form on the surface of the cell. If it formed inside, its motion would damage the cell, or would even destroy it. This again pre-supposes a planned design and eliminates all possibility of chance.

When you mount the proteins comprising the hairs—tubulin, dynein, nexin and the others—onto a cell, these will not suddenly trans-

## THE BACTERIAL WHIP REFUTES EVOLUTIONISTS!

*Evolutionists regard single-cell bacteria as among "the most primitive organisms." But in fact, bacteria have a mobile internal engine and a whip-like extension. This mechanism, which allows the "primitive" bacterium to move, consists of 240 separate proteins. These proteins act as the alternator, regulator or battery, just as in a car. Some send signals to start or shut down the "engine" that causes the whip to move, others constitute joints that permit it to move, and still others provide flexibility to the membrane covering the whip.*

*If just one of these proteins in the whip were missing, what would happen?*

*If any one failed to form or were defective, the whip would not work, and would be of no use to the bacterium. Therefore, this whip must have existed fully formed, ever since the very first bacterium came into being. Once again, this invalidates the theory of evolution's claim of "gradual development."*

*Bacteria are one of the most minute living things on Earth, yet their detailed designs clearly verify creation. God shows us His incomparable art of creation in all the entities that He has created, great and small.*

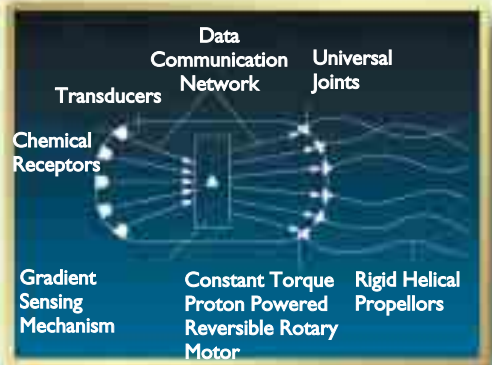



form into tiny, moving hairs. In order for a cell to possess these hairs, a great deal more is necessary. Detailed biochemical analysis reveals that there are more than 200 proteins in the hairs in a cell.

These are just a few details, all of vital importance, of the complex system that allows these tiny hairs to function. Any deficiency or error in the system will mean the hair attaching to another structure inside the cell, or a difference in the hair's elasticity, or a change in the length of time the tail moves, or a change in the nature of the membrane belonging to the hair. There is thus no room for the slightest mistake.

In order for more than 200 proteins to combine to produce all these characteristics, they must have emerged in exactly the right place and in exactly the right sequence. This clearly exposes such meaningless evolutionist scenarios as "formation over time" and shows that the structure comprising the cells was created.

The design in these tiny hairs that cause cells to move is just one example clearly revealing the illogical nature of evolutionists' claims. In a hardware store with a great quantity of electrical and mechanical items, is it possible for cogs to fit themselves to a pivot; for wires to wind themselves round to form a coil; and for the electrical switch and cables to power the engine's motor all by themselves? You needn't be an electrical or mechanical engineer to realize just how nonsensical that idea is, just as you needn't be a biochemist to realize that the hairs' movement system couldn't have arisen by chance.

Micro-tubules are also present in the body of the cell, quite apart from the hairs. In the cell, their main function is to support the cell's shape and structure. Furthermore, what we have described as motor proteins have other functions in the cell, too. For example, they travel the length of the micro-tubules for the transportation of various com-

ponents within the cell, using the micro-tubules like highways to go from one point to another.

Every detail of the special structure in the tiny hairs is the product of separate engineering and reveal the knowledge of their designer. The intelligence manifested in the micro-hairs belongs to God. God has created all entities with a perfect and incomparable design. Contemplating them will be an important help to comprehending the greatness of God. In one verse it is revealed:

**Say: "Am I to desire other than God as Lord when He is the Lord of all things?" What each self earns is for itself alone. No burden-bearer can bear another's burden. Then you will return to your Lord, and He will inform you regarding the things about which you differed. (Surat al-An'am : 164)**

### **CAN A WINCH CAPABLE OF LIFTING A TREE PICK PEAS OFF THE GROUND?**

With its trunk, the elephant can pick up and carry a tree trunk, as well as pick a pea off the ground and lift it to its mouth. In its trunk, it can carry up to four liters of water for drinking or washing, and spurt that water out like a hose. It can also use its trunk as a means of communication to gather the herd together or warn them to flee. Thanks to this organ's perfect design with its 50,000 muscles, it can perform actions requiring the greatest strength and sensitivity.

Computer and electronic technology have seen enormous advances in recent years. Yet we have not yet managed to produce machines strong as a winch, yet capable of such sensitive actions as picking up a pea.

The elephant's trunk is an organ with a special design, each of its features showing the flawless and incomparable nature of God's creation.



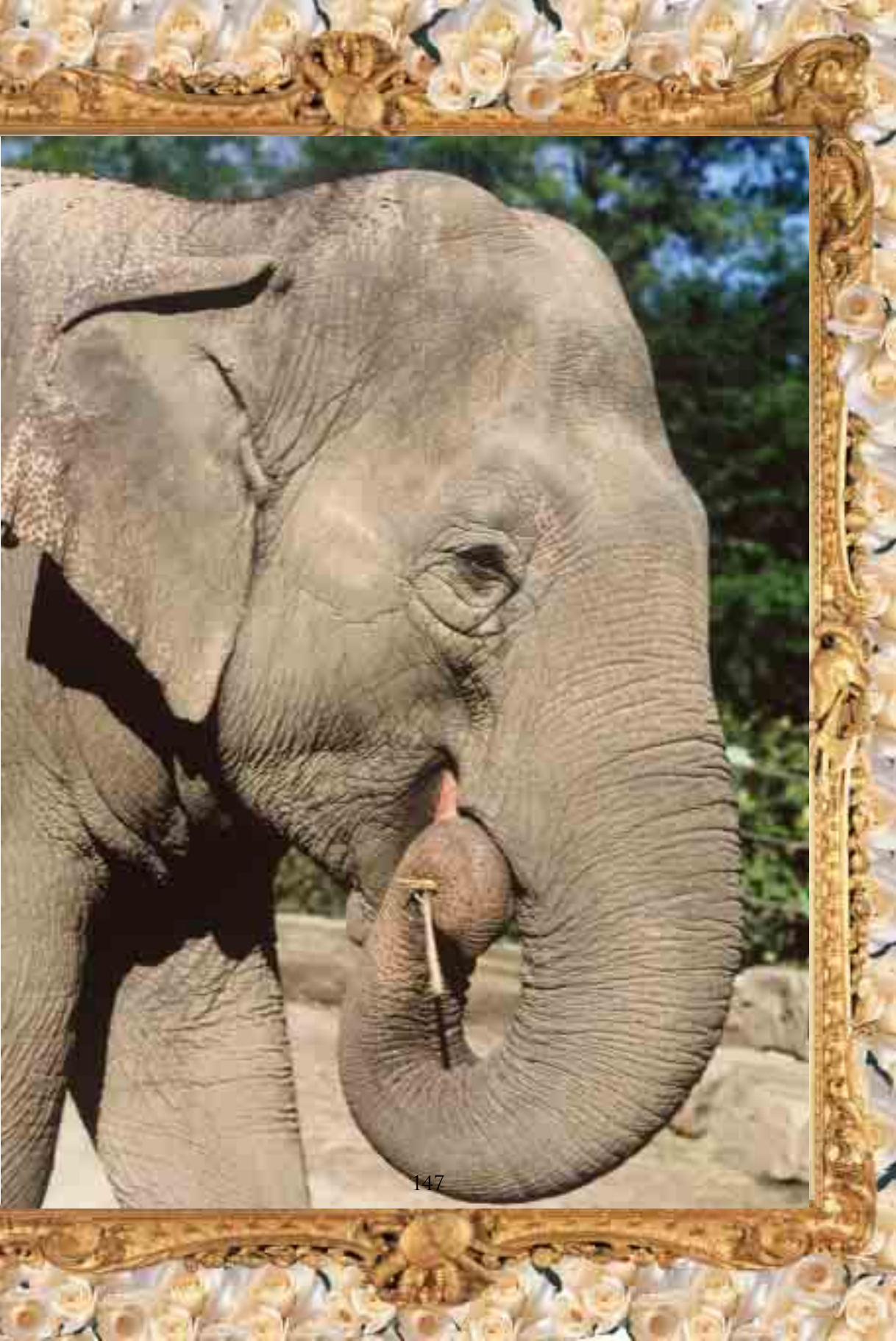

Engineering in Nature

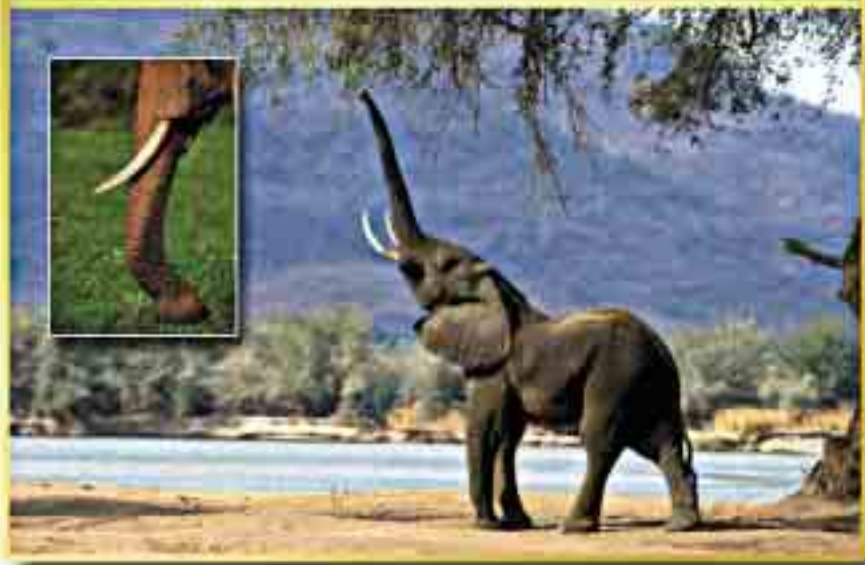

*With their strong trunks, elephants can tear a tree out of the ground and carry it along. Yet they can also perform tasks requiring the greatest sensitivity, such as picking off the ground a small bunch of grass, or even a single pea. If the muscles comprising the trunk numbered fewer than 50,000, it would not be this functional. Almighty God, the Lord of the Worlds, has determined the number, location and strength of the elephant's muscles.*



### THE WORLD'S THINNEST FEEDING TUBE

For a female mosquito, it's vitally important to be able to suck blood very quickly. Her suction system must therefore be 100% compatible with the structure of her host's blood.

Unlike most liquids, blood changes its viscosity according to the diameter of the tube through which it flows. In wide tubes, the alluvia can move easily since they are randomly distributed in the liquid plasma. Yet in minute tubes smaller than a tenth of a millimeter across, the viscosity of blood starts to increase. In tubes of that size, the red blood cells flatten out and concentrate in the middle of the tube. In tubes smaller than a hundredth of

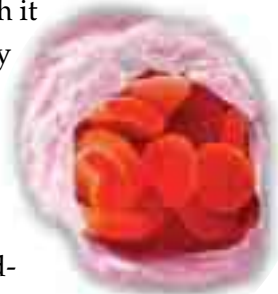

*Red blood cells*

a millimeter in diameter, the viscosity of the blood reaches its highest level, because the diameter of the blood cells has approached that of the tube itself. Sucking blood has become as difficult as sucking peas through a straw.

Creatures that feed by sucking blood display a most surprising compatibility. The feeding tubes of mosquitoes and other blood-sucking creatures never falls below one hundredth of a millimeter in di-



Adnan Oktar

ameter.<sup>43</sup> Thanks to this they never experience any difficulty in ingesting blood.

It's worth noting that there are no exceptions in this regard: The same perfection is evident in all blood-sucking creatures. Could all of them have measured the diameter of blood cells and designed their feeding tubes accordingly? Or could they have carried out various experiments to determine a tube wide enough to allow blood cells to pass, but small enough not to restrict the cells' movement capacities? If so, then how did those individuals who were successful at the first attempt manage to transmit that information and thus save subsequent generations from extinction?

Of course, none of these things could possibly have happened. No insect can be aware of the structure of another living thing's blood, and that various cells within that blood affect the blood's viscosity.

No rational person would ever imagine such things upon learning that the mosquito's bodily structure is entirely compatible with blood sucking, or imagine that some insect discovered all this for itself one day. It is clear that such compatibility could not come about by chance.

In order for the mosquito to suck blood, it's not sufficient for it to possess a tube through which blood cells can pass. Above all it needs a force to make the blood move through the tube, and a way to produce that force. There are muscles in the mosquito's head, and as the muscles expand and contract, there is a fall in pressure. As a result, blood begins moving up the feeding tube.

There is only one explanation for the mosquito's perfect mechanisms: It is God Who creates them. The blood cell and the tube through which it passes were both created by a power, together with all the properties they possess. That power is God, the omniscient and flawless Creator.



## CREATURES WITH PRESSURE-RESISTANT TISSUES

Another blood-sucker, the "assassin bug," also known by the scientific name of *Rhodnius prolixus*, possesses a most perfect pumping mechanism. The insect's head is almost entirely composed of cavities and muscles. Thanks to this design, the insect is able to create a pressure differential between the two ends of its feeding tube. Due to that difference, blood moves up the tube at 5 meters per second—a particularly fast speed that would cause damage under normal conditions. Yet no damage is inflicted on the insect's feeding tube or any other tissue through which



*Rhodnius prolixus*

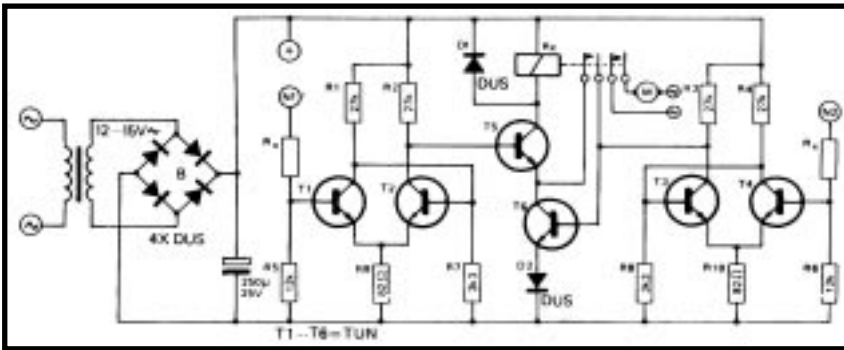

A diagram of the electrical circuit of a detector controlling water levels, which contain a great deal of information about where the electronic components are to be connected to one another. The detector can work only if the plan is completely adhered to, in every detail. If just one component is removed, or if you alter its connections, the machine cannot work. Similarly, the slightest deficiency in the mosquito's tension detectors system will mean that its entire sucking system will fail to function. Thus, mosquitoes could not have attained their present structure by a series of consecutive stages. In a single action, God has created mosquitoes and all other living things perfectly, with all their present features.

the blood moves, because they are all resistant to its speed and pressure. Thanks to this system, the insect is able to ingest up to 300 micro-liters of blood in 15 minutes—the equivalent of a human being drinking 200 liters (52 gallons) of water.<sup>44</sup>

These insects are similar to mosquitoes, in that they're able to expand their bodies considerably as they drink. For example, a mosquito that ingests 4 micro-liters of blood consumes a great deal more than the volume of its own body. So what is it that prevents the mosquito from bursting as a result of such enormous consumption?

As with other blood-suckers, working in tandem with the mosquito's digestive system are tension sensors that tell them when to drink blood and when to stop. Human beings use similar systems to those in the mosquito and the assassin bug in water-storage facilities. The water drawn up by pumps is transferred into tanks, where special sensors control the water level. When water in the tanks reaches the maximum level, the pump shuts down automatically.

To make a crude comparison of the two systems, water pumps usually weigh tens of kilos or more, are very loud, and require large amounts of energy. In time, the pipes and the gaskets wear out, and water begins to escape, unless they are maintained to prevent corrosion and rust.

The sucking system in the mosquito's head is less than  $1\text{mm}^3$  in size. It





makes no noise as it works, and neither is there ever any leakage. Never does it need to be maintained even once over the course of the insect's life.

Mosquitoes and other insects cannot create by themselves the perfect systems they possess. All are the products of a special design. These systems, with their features far superior to those created by man, could not have come about by chance. The suction and storage systems of both the mosquito and the assassin bug constitute a technical whole, right down to the tiniest detail. A single error in the system, or any deficiency in its components, could cost these creatures their lives. Thus these creatures cannot have acquired these features as the result of a string of coincidences, as the theory of evolution maintains.

It is God, the Omniscient and Almighty, Who meets all living things' needs, Who created all things on Earth, living and non-living. God is the Almighty, and there is no other Creator than Him. In one verse our Lord reveals:

**This is God's creation. Show me then what those besides Him have created! The wrongdoers are clearly misguided. (Surah Luqman: 11)**

The more one researches, the greater the perfection one encounters.

### **THE GECKO AND MOLECULAR GRAVITY**

The gecko, a small, harmless lizard that lives in tropical regions, possesses a characteristic which distinguishes it from other lizards. It can walk on walls, or even ceilings, as easily as if walking on the ground. It can even run upside down on varnished surfaces.<sup>45</sup>

What is this system that permits the gecko's feet to cling so tightly to the surface and move so astonishingly?

The gecko does not cling to the ceiling by secreting an adhesive substance, since the lizard has no glands with which to do such a thing. Furthermore, such a system might also stick the gecko to a surface, but not allow it to move.

Nor does the reptile's ability stem from a structure like a suction cup. The gecko's feet also work perfectly in a vacuum, and a suction cup cannot attach itself to the ceiling in such an environment.

Neither is there any question of electrostatic attraction. Experiments have proven that the gecko's feet function even in ion-charged air. Were electrostatic attraction being used, the ions added to the air diminish the force of attraction and prevent the lizard holding on.

Research has shown that the mechanism in the gecko's feet is an example of superior engineering. In fact, the lizard's entire foot has been designed for climbing.

Kellar Autumn, an environmental physiologist from the Lewis & Clark High School in Portland, and the California Berkeley University bio-engineer Robert Full, and supported by Massachusetts IS Robotics, set up a team to perform a microscopic study of the gecko's climbing ability.<sup>46</sup>

The results revealed that in the gecko's feet is a force of which perhaps only nuclear physicists are aware.

### **Special Feet Consisting of Thousands of Micro-Hairs**

The tips of the gecko's toes are covered with thin leaves of skin, just like the pages of a book. Every leaf, in turn, is covered in a special tissue known as setae, hair-like protuberances, whose ends are divided into thousands of microscopic tips.

On the gecko's toe, an area the size of a pinhead contains an average of 5,000 micro-hairs. That means each of the animal's feet contains



Harun Yahya

around half a million hairs.

Every single hair consists of between 400 and 1,000 protrusions, all located in such a way as to face the animal's heels. The tip of each one is about 5,000th of a millimeter thick. The millions of microscopic tips on the gecko's feet use the gravitational force of the atoms in the surface it walks on to firmly adhere to that surface.

As the gecko walks, it places the soles of its feet on the surface and pulls them slightly backwards, ensuring maximum contact between the hairs and the surface. Its hairs cling tightly to microscopic protrusions and cavities on the surface, too small to be seen with the naked eye. Thus on the molecular level, a slight gravitational attraction forms between the foot and the surface, known as the Van der Waals Force in quantum physics.<sup>47</sup>



Adnan Oktar

This force is also present when you place your hand on the wall, but it is very weak. If you were to view your hand at the atomic level, you would see that its surface is covered in tiny crests, and only the few atoms at the tops of these crests make actual contact with the wall. However, the thousands of spatulate tips on the gecko's feet stick to the wall with greater force.

If the gecko's toes really were covered with an adhesive (or with suction caps, as scientists once believed) then every time it lifted its feet the lizard would have to expend considerable energy to break that adhesion. According to the findings of the research team, however, in order for the gecko to lift its feet, it needs only to change the angle at which it makes contact with the wall.<sup>48</sup>

The position and concentration of the micro-hairs on the gecko's feet give rise to the Van der Waals Force, which overcomes the force of gravity. When it wishes to take another step, the reptile bends the sole of its foot forward and raises it by expending a greater molecular force than that of gravity.<sup>49</sup>

Clearly, the number and angle of the hairs on the creature's feet are based on sensitive engineering. Were the density of the hairs any greater, the animal would stick to the ceiling; any less, or if the hairs were located at a different angle, it would fall off.

Yet such a thing never happens. The density of the hairs that give rise to the Van der Waals force is exactly right.

If a gecko that had 2,000 hairs per square millimeter instead of 2 million, an insufficient Van der Waals force would form, and it would fall off as it attempted to walk on the ceiling. The existence of the whole elaborate hair structure would be to no avail.

### **The Coordination in the Gecko's Feet**

In addition to all this, the gecko lizard must also enjoy perfect co-



ordination in its four feet to move over surfaces, climb walls with ease, and walk on the ceiling without falling off.

As it walks swiftly across the ceiling, the animal makes completely different movements with all its feet, simultaneously and without error, without its feet becoming tangled up.

Bear in mind how difficult it is to make opposite movements with your opposite hand and foot at the same time, you can better understand the difficulty of the gecko's moving all four feet.

Research reveals facts that are quite astonishing in all regards. First of all, the gecko needs to be aware of the function the Van der Waals force serves. Yet how did it come by this information, which even a great many university undergraduates have never heard of?

Is it possible for a lizard to "evolve" these tiny hairs, and to calculate their numbers and angles in such a way as to enable their weight-bearing capacities? No doubt, the location of the hairs on the sole of the gecko's foot—in the ideal numbers, at the ideal angle and order—could not have come about as a result of the gecko's own reasoning abilities.

In addition, the gecko also needs a skeleton, and nervous and muscular systems capable of coordinating its four feet so perfectly. It is of course out of the question for a lizard to design all of these itself and to create them within its own body.

Only in the last century have human beings discovered the structure and nature of the atom. The gecko, on the other



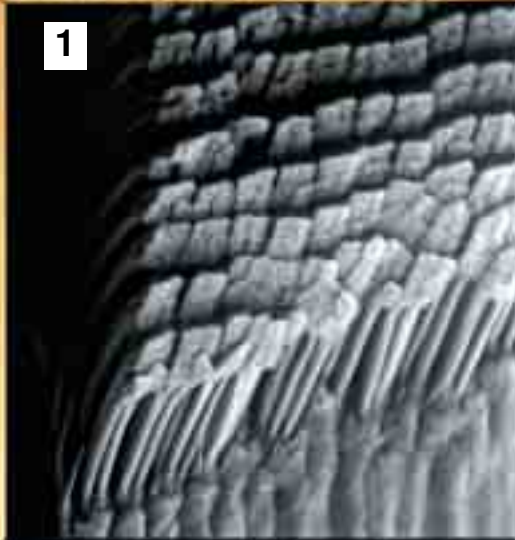

1

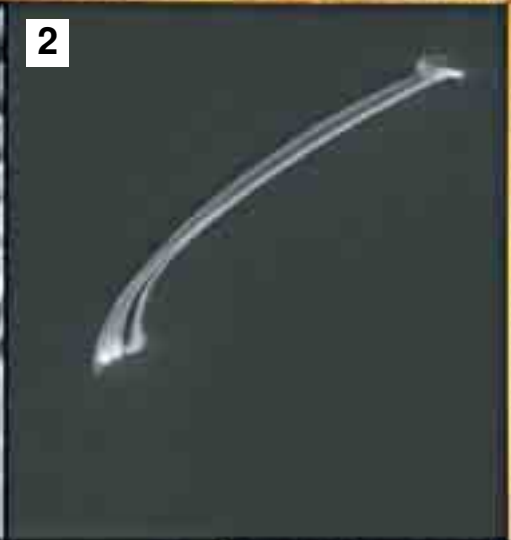

2

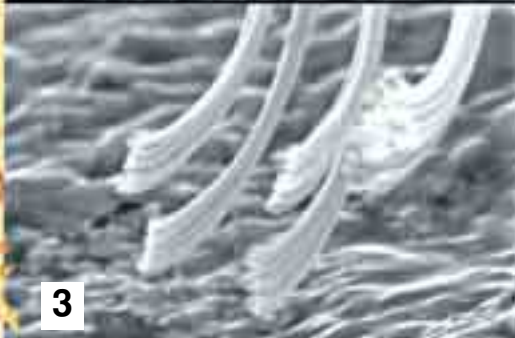

3



4

The gecko's toes are covered with microscopic hairs known as setae (1). These hairs (2) are so tiny that up to 5,000 could fit on the head of a pin. And at the end of every seta are also 1,000 hair-like structures (4). These extremely minute hairs let the animal cling onto surfaces. The hairs maintain this adhesive property up to a specific angle ( $\alpha$ ). When the angle changes, the lizard's foot immediately lifts off the surface (5).

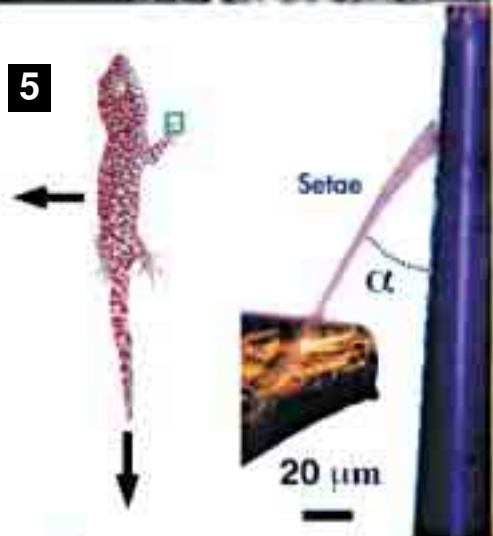

5



Harun Yahya

hand, is a species of reptile that can't conceivably know about the atom and its force of gravity.

Every person of common sense knows that these features cannot have come about on their own, and that all are products of a special design. Moreover, all the geckos that have ever lived have possessed these features, which goes to show that God created geckos in a single moment, together with all their characteristics.

Both their bodies and their behavior reveal that God created all living things, together with all their attributes. Thinking people view the design in the gecko as one of the proofs of God's omniscience and flawless creation. In one verse it is revealed that God is the Creator of all living things:

**God created every animal from water. Some of them go on their bellies, some of them on two legs, and some on four. God creates whatever He wills. God has power over all things. (Surat an-Nur: 45)**





*Chapter Five*

**Undersea  
Engineers**





# G

reat numbers of engineers and scientists employ advanced technologies in the manufacture of present-day submarines. Their aim is to produce machines that can stay longer underwater, with a greater capacity for movement with the expenditure of less energy. Yet despite all these studies and the bringing together of all their efforts, all they have achieved is a ship that can move forward underwater and rise and dive as required.

In addition, submarines must be made of very strong metals in order to resist the high pressures underwater. Inside, a large area has to be set aside for storing provisions and materials that let their passengers survive on the sea bed. Work is continuing, with intense efforts to resolve problems and improve the technology used in these



ships. However, a great number and variety of creatures live beneath the sea. They, too, are exposed to pressure and must meet such needs as food and protection. Yet none of the difficulties that submarines must contend with constitute a problem for these creatures.

All marine creatures, from the tiniest fish to the largest whale, move around easily and use their superior maneuvering ability to swim and feed in the most productive manner. All species of fish have been designed to swim perfectly. Their fins have been specially located, and the shape of their tails, the size of their gills, and the protrusions and cavities in their skins all meet their needs in the best possible manner.

As you'll see in the pages that follow, the design in these living



*God has created fish with a physical form that allows them to move through water with no difficulty. Their structure, oval at the front and resembling a pointed shuttle at the back, reduces the friction of the water to a minimum. Some fish, skates for example, possess a different shape that's equally ideal for moving through water.*



things is utterly flawless. The systems that let them resist pressure, feed, respire and defend themselves have existed in their bodies ever since these creatures first appeared. Any other possibility is out of the question, since these creatures would not be able to survive with partly functional, deficient "half-evolved" systems.

This proves that marine creatures appeared in a single instant, and fully formed. In other words, God created them all.

### **FISHES' HIGHLY EFFICIENT SWIMMING TECHNIQUES**

Most machines produce power by means of shafts that revolve at varying speeds around their own axes. Animals also produce power, although their working systems are very different, in muscles entirely surrounded by blood vessels and nerves. Thus, they move thanks to structures far more complex and perfectly design than machines. Living

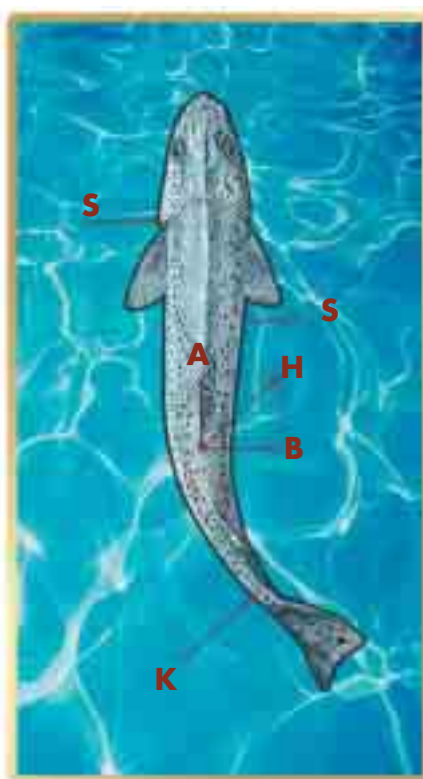

*The forces acting on a fish as it swims. The movement of its tail from left to right creates two forces, one acting in the same direction as the fish moves (A) and another to the side (B). Force A propels the fish forward. Force B influences the fish's turning. The resultant that emerges from these two forces (H) actually determines the direction and speed of movement. When the fish chooses to remain motionless in the water, it employs a force (K) to balance the forces from the water on its sides (S).*

things' power-creating engines are their muscles, capable of expanding and contracting like backward and forward-moving levers.

One example of these engines can be seen in marine creatures, most of whose movement takes place in a single plane. You can envisage that motion by imagining the way fish swim in water. The interconnected vertebrae in the fish's backbone constantly turns to right and left, so that in order to swim, all a fish needs to do is to wave its tail.

Under normal conditions, when the tail turns in one direction, the fish's head should move in the opposite direction, propelled with the same force. Yet that never happens, because fishes' bodies have been

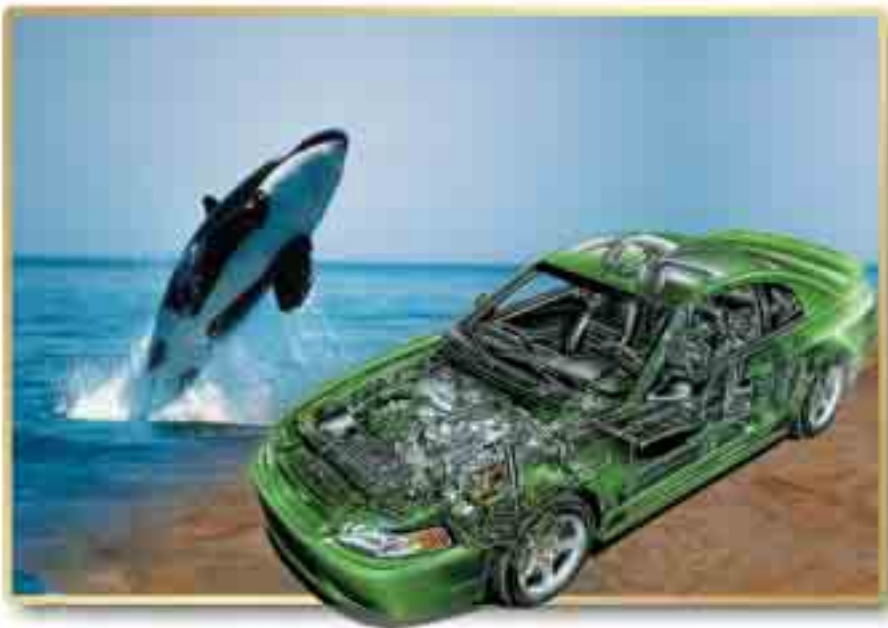

*Fish seem to have very simple physical structures, but the fact is, the systems and mechanisms they employ to move in the water are the result of planning as sensitive as that of the latest model car.*



created in such a way as to eliminate that effect.

At the same time, the water acts on the head with a vertical force during movement. All this gives rise to the movement of the head part of the fish being smaller to that of the tail. It is this difference that allows the fish to move in the water.

How quickly the fish moves depend on how rapidly the axis passing through its backbone moves to right and left. The speed increases as the fin nears the axis, and decreases as it moves away.

#### • An Optimally Efficient System

How efficient is this system? When we compare a waving tail and a submarine engine, what kind of results emerge?

Professor Richard Bainbridge of Cambridge University and his team set out to answer these questions with observations from an underwater camera.

Their observations of a fish that was still and calm revealed that when alarmed, it went into action at an amazing speed.

From a standstill, a small freshwater fish can move forward 10 body lengths in the space of one second. A 20 cm (8 inch) fish can achieve a speed of 8 kilometers (4 miles) per hour. Speed increases with the size of the fish. Professor Bainbridge observed that a 32 cm (one foot) long fish achieved a sustained speed of 13 kilometers (6.5 miles) per hour.<sup>50</sup> That speed is directly related to the frequency at which the fish moves its tail. The more it waves its tail in a short period of time, the greater the speed.

In swimming, fish expend large amounts of energy. However, sudden acceleration is vitally important to them, since fish need sudden bursts of speed for hunting and to escape from predators.



From a stationary position, some small fish can reach their maximum speeds in as little as  $1/20$ th of a second. In that time, they can produce a propulsive force up to four times their own weight.

To fully understand the significance of these figures, consider that sports cars can accelerate from 0 to 100 kilometers per hour in between four and six seconds, and need a great deal longer to reach their maximum speeds.

Another point is that. Fish exhibit these superior performances underwater and in some species, even against the current. Since the resistance of water is greater than that of air, clearly that the fishes' performance is a most superior one.

The salmon is no doubt the best example in this regard.

As we've seen, salmon can lay their eggs only if they can return from the sea and reach the rivers where they were born. In order for salmon reach their birthplaces, they must constantly swim against the current of the river. They may have to overcome waterfalls in front of them, leaping four meters forward and two meters above the level of the water. To do so, salmon need to leave the water at a speed of 24 kilometers per hour (15 miles/hour). Falling after such a leap could be lethal for many creatures. Yet the





salmon very seldom comes to any harm, and continues on its way. Did salmon's muscular and skeletal structures not permit them to make such leaps, they could not of course survive. (For detailed information, see Chapter 2: "The Salmon's Astonishing Direction Finding Systems.")

• **How Are Fish Able to Move in All Directions?**

As we know, fish are not restricted to moving forward and backward. A fish unable to move up and down will be unable to survive. This problem has been overcome with the air sacs created in fishes' bodies, thanks to which they can dive into the depths or rise up to the surface. When fish dive down to the bottom, the physical effects of the water on their bodies change. They adapt to changing conditions at various depths by reducing or increasing the gas in the air sacs.

In addition, fishes' centers of gravity are generally designed to pass through their air sacs, so if their balance is disrupted, they can regain their desired position by only small movements of their fins.

• **The Special Skin That Prevents Friction**

Most fish are covered in a highly resistant skin, consisting of an upper and a lower layer. The upper layer contains glands secreting mucus, whose slippery nature reduces friction to a minimum during movement in the water. It also makes it more difficult for predators to seize them, and protects the fish from disease-causing organisms.<sup>51</sup>

Also, in the upper layer of fishes' skins is a keratin<sup>52</sup>-like layer that ensures no outside water enters the body. Were it not for that layer, the entry of water would impair the internal pressure balance in the fish's body, and the fish would die.<sup>53</sup>

The designs and functions of the several systems that facilitate the fish's movement through the water are all different. Yet in the absence of one, the others would serve no purpose, and any deficiency would mean death for the fish.

For instance, the mucus layer needs to have both specific levels of slipperiness and stickiness and also an anti-microbial property. It's of course a miracle that these conditions are achieved not in giant chemical factories, but in a layer just a few millimeters thick under the fish's skin. These features require the greatest wisdom, and are proofs that God has created fish. God reveals his omnipotence in a verse:

**... everything in the heavens and Earth belongs to Him. Everything is obedient to Him, the Originator of the heavens and Earth. When He decides on something, He just says to it, 'Be!' and it is. (Surat al-Baqara: 116-117)**







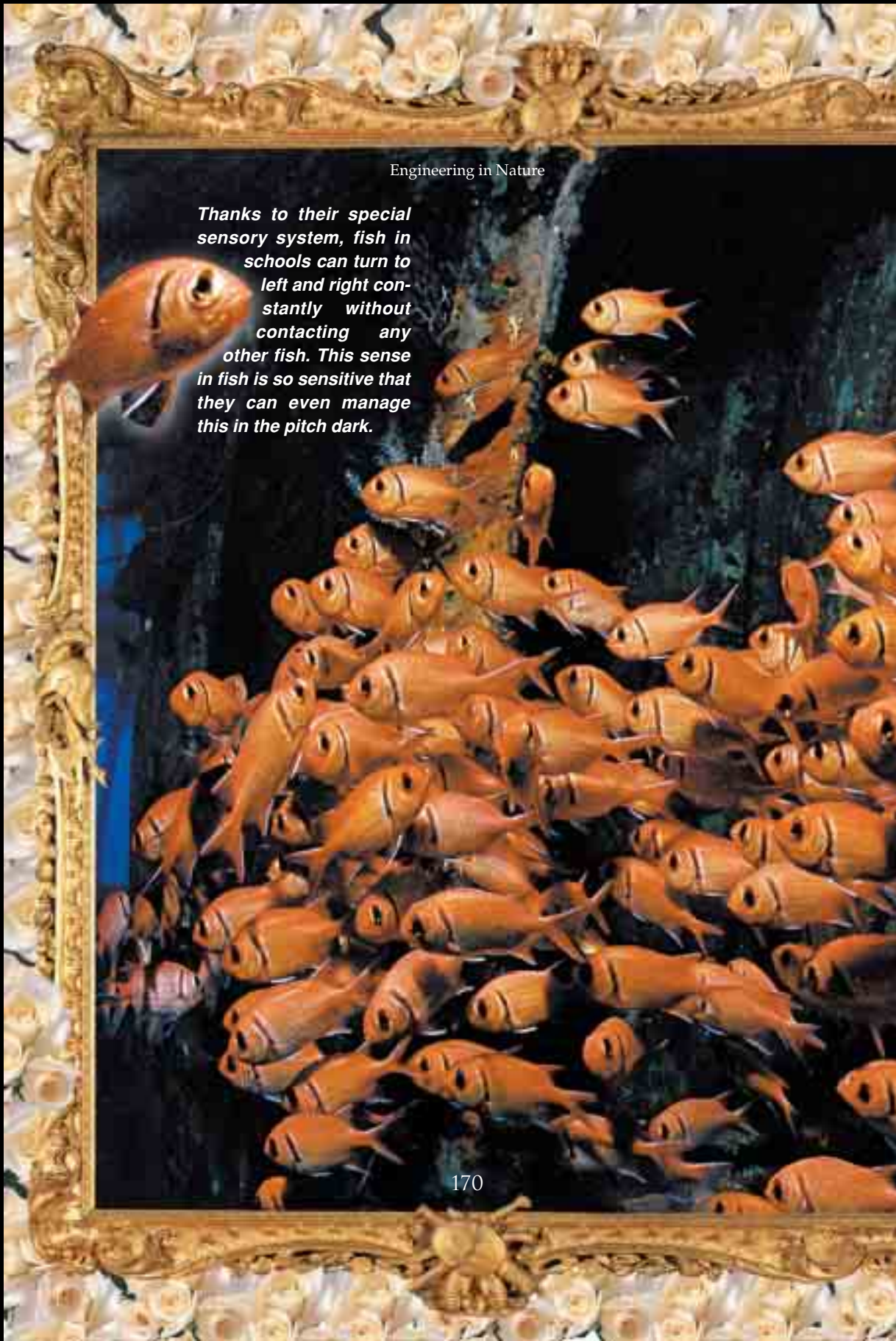

*Evolutionists claim that water-dwelling fish turned into land animals over tens of millions of years. Yet countless anatomical and physical factors make this impossible. For example, fishes' muscular and skeletal system can bear their weight in the water, but in order to survive after emerging onto dry land, they would need an entirely different structure. Land animals' metabolism can adapt to instant temperature changes. Since no sudden temperature changes occur under water, however, fish lack the necessary metabolism to cope with them. Animals living on dry land have a skin structure that reduces water loss—and thus, thirst—to a minimum. Creatures living in water, however, do not experience thirst, so their skins are not suited to waterless environments. The kidney system of land-dwellers uses the minimum amount of water. But since water is abundant in the fishes' habitat, fish have no kidneys. So for the transition from sea to land to take place, fish would need to suddenly develop an advanced kidney system. Furthermore, fish take in the oxygen dissolved in water through their gills, and can't survive out of water for more than a few minutes. To survive on land, they would swiftly need to acquire a flawless lung system. It is impossible for all these features to form in a living thing by chance and in stages. In conclusion, it's scientifically and logically impossible for an aquatic creature to emerge onto dry land and adapt to it, in other words, to evolve.*

*Thanks to their special sensory system, fish in schools can turn to left and right constantly without contacting any other fish. This sense in fish is so sensitive that they can even manage this in the pitch dark.*





A composite image featuring a central photograph of a diver in a blue tank and green wetsuit, illuminated by a bright flashlight. The diver is surrounded by a large school of orange and silver fish. The entire scene is enclosed within an ornate, gold-colored frame decorated with white roses.

Harun Yahya

Adnan Oktar

### The Incomparable Sensory System in Fish

Imagine that you are swimming along in a huge school of fish. If every individual in it wants to suddenly turn right or left—and what's more, in dim light or even darkness—will you be able to avoid bumping into the other fish? Definitely not!

Yet such movements, impossible for us, are perfectly simple for fish, because they have been created with a perfect sensory system known as the lateral line. This system consists of dots or lines along both sides of the body, containing sensory cells in a channel under the skin.<sup>54</sup>

The lateral lines immediately identify the slightest change in outside pressure, water movement, or strength or direction of the current. In contrast to the sensory systems of land animals, fish use the water's pressure waves and its feature of transportation and reservation of chemicals. Through these sensory systems, fish can half-feel and half-hear vibrations. Thus they can determine the presence of a





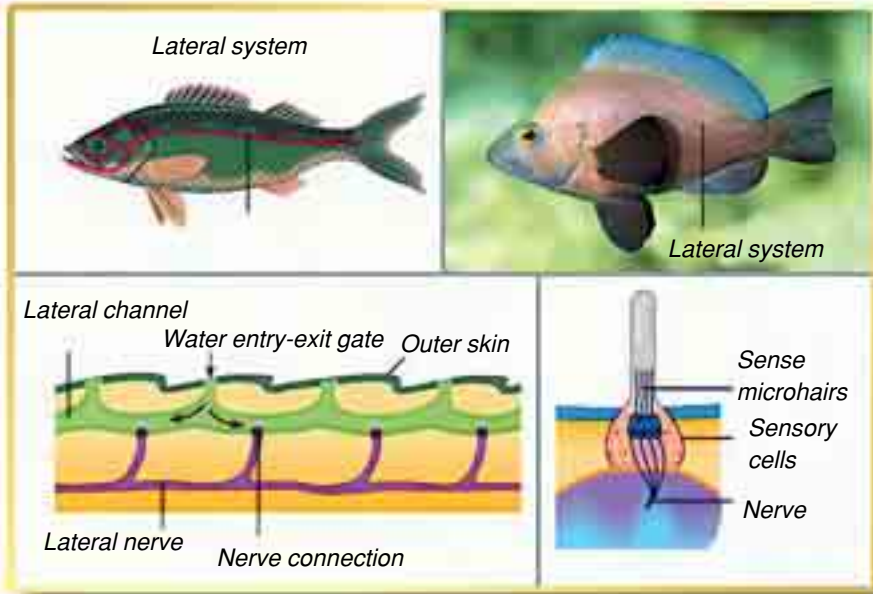

*Fish have been created with a perfect sensory system known as the lateral line, consisting of spots or broken lines extending along both sides of the fish. The system's sensory cells lie in a channel beneath the skin.*

predator or obstacle before they actually see it, can locate their prey or predators and find their way among the water currents. In particular, their lateral line lets them detect low frequencies nearby—footsteps on the shore or bodies falling into the water—and react accordingly.

By the water's edge, you can speak, sing or listen to the radio, and not alarm the fish. Yet if you do anything to set the water in motion—for instance, if you rock a jetty or throw a stone into the water—all the fish around will immediately flee.

Nearby objects reflect the vibrations reaching them. In this way, when a wave lands on the shore, the returning vibrations reach the



*Like many other fish, the splendid-looking beta (or Siamese) fighting fish uses its own waves to determine its surroundings. When threatened, the male warns its young by beating its fins to sets up waves.*

fish's body in a short time. The lateral lines in the fish's body analyze these time frames and from these vibrations, the fish is able to establish an image of its surroundings. The fish can acquire more information by swimming faster or creating more vibrations of its own.

The system works so well that the fish can perform very detailed scanning. For example, the Mexican blind cave fish depends entirely on its lateral lines. Although it has no eyes, it can perceive objects no larger than a pinhead in the darkness of the cave it inhabits.<sup>55</sup>

In low visibility waters in particular, fish which swim in large schools in close proximity to one another use their lateral lines in order to detect rapid maneuvers.<sup>56</sup>



These sense organs possess a most complex structure. Of course, it's impossible for such a sensory system to come about gradually and in stages, through random coincidences. In order for the fish to survive, it's also essential that the system emerge all at once. This is yet another indication that fish did not come into existence by evolving, as evolutionists would have us believe, but that they were created by God, flawlessly and with no elements lacking.

### **PENGUINS AND THE POTENTIAL ENERGY-CHEMICAL ENERGY TRANSITION**

The time when Emperor Penguins brood coincides with the polar winter. While the male penguins sit on the eggs, the females go off to find food for the chicks that will hatch. The distance between the nesting site and the nearest food source can sometimes exceed 100 kilometers. For roughly four months until her chick hatches, the mother penguin swims around and collects food in her craw. When she takes over the care of the new hatchling, the father penguin departs on a walk for hunting that can last for a very long time.<sup>57</sup>

The very surprising element in all this is that although penguins have fairly large bodies, their very short legs make walking difficult. Under normal conditions, this would lead to a considerable expense of energy. Penguins setting off on a long journey with only limited



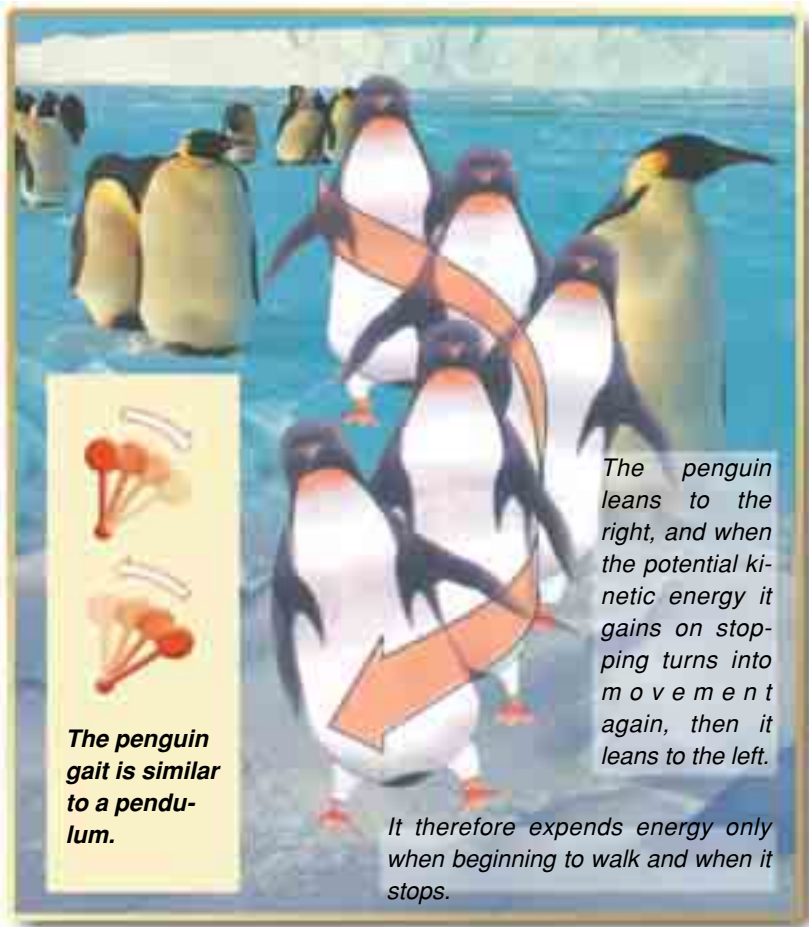

amounts of food should die of starvation.

So how is it, that in the face of such an apparent disadvantage, penguins can walk for many kilometers and reach the sea?

The answer reveals yet another miracle of creation.

Penguins walk by waddling from right to left, and back again. This pendulum-like gait allows penguins to save considerable quantities of energy. Penguins can overcome the disadvantage of exceedingly



short legs by stepping sideways, thus tiring their muscles less. Indeed, at the end of every step they have meanwhile stored sufficient energy for the next one.<sup>58</sup>

Were they to walk straight instead of side to side, penguins would have to expend twice as much energy as any animal their size. Yet thanks to this special gait, the penguin expends energy only when beginning walking, and when stopping. And its limited amount of stored nourishment is enough for it to reach the sea.

Of course, a gait that conserves energy is not something the penguin could have discovered on its own. Moreover, this is something adopted by all penguins, not just one.

From the moment they are born, penguins know how to survive under the harsh conditions of winter. Any other behavior would have serious consequences, even death. It is out of the question for a penguin in the freezing cold to experiment with what it needs to do and finally decide to adopt this particular gait, which is yet another proof of God's love and compassion for living things. It is God Who creates penguins and inspires their behavior in them, Who has shaped all living things and created them together with all their incomparably perfect features.



CONCLUSION





A

fter reading this book, your way of looking at a great many things will change. The ant you see will no longer be just any familiar insect, since now you are aware that it is an expert chemist producing formic acid. You've learned that insects and butterflies emit special scents containing signals, and that fish protect themselves with perfect sensory systems. This is all special knowledge given you by God, through the means of this book, to show you His infinite might and artistry. This knowledge will let you see the beauties and miracles around you, and to ponder about them all.

But what advantage does perceiving and thinking about these beauties and miracles provide?

You will benefit more than you can imagine.

First of all, there is an idea you'll be reminded of at every moment of your daily life: that living things were created! Seeing the signs around you that lead to faith and encountering astonishing works of art wherever you go will help you realize the falsity of the theory of evolution, which is based solely on chance.

What good will understanding that do you?

By realizing the invalidity of the theory of evolution, you will see how all the efforts made to deny creation are hollow and irrational—despite all the forces mustered to support it— and that those efforts will always be in vain.

From discovering the designs around you, you will benefit in a second way by beginning to take pleasure from the beauty laid out

before you. The time you set aside for your daily chores will grow ever lovelier as you see the perfection of the things around you assumes a new significance. As you acquire this perspective, ordinary things you pass by without really seeing will become sources of great joy and enthusiasm.

These are the blessings and beauties you will encounter initially.

Beyond all this, any single living thing you consider will bring you a gain that cannot be compared to anything else in this world. As you learn that an ant possesses an extraordinary chemical laboratory, you will actually come face to face with the hidden intelligence that reigns in the body of this creature. Pervading every part of it is a flawless perfection that human intelligence, knowledge and experience can never match. The ant has complex structures and systems whose secrets have taken thousands of years of accumulated knowledge and experience to unravel. Moreover, there are countless miracles in life that modern science and technology have not yet understood, let alone construct anything comparable. In conclusion, the more you discover examples of this perfect creation in living things, the more closely you will witness the existence of God and His infinite and superior attributes.

Also, most importantly, you will realize the truth that your own creation is not for nothing. There is a point to your existence on Earth. Since everything on Earth, yourself included, is part of this wide-ranging creation, and since you have been given a soul and understanding with which to comprehend all this, then you must owe a debt to God, Who gave them to you. This conclusion, which you can draw from pondering just a single ant, will be one of your greatest gain. From now on, you will look at the works of God on Earth and the miracles in His creation, take pleasure from all of them and seek to please God rather than those around you. You will thus be freed from the in-



fluence of worldly concerns and difficulties. You will understand destiny, believe in the Hereafter, and comprehend that the life of this world has been created solely as a test. You will understand that exalting all of this world's forms of expectation and desire,, and being seized by anger and passion, will gain you absolutely nothing. With great excitement, you will realize, that you will have true life only in the Hereafter.

Grasping this truth you will turn your life away from this world and solely towards the Hereafter. As you believe in God and seek His approval, His Paradise, with its matchless beauties and endless blessings, is promised to you. You will remain there not for a hundred years, not for 1,000 years or a million, but for all eternity. You will be given infinite beautiful things and blessings. Everything your heart desires will be yours. The most important reward awaiting you there is the great mercy of Our Lord.

Even the small example of a single ant will allow you to grasp this great truth, attain this great prize, and shape your life in light of them. Realizing these truths while still in this world brings infinite benefits. On the other hand, failing to realize them, or ignoring them and becoming arrogant, will be the beginning of a terrible course from which there can be no return, only regret.

**Every self will taste death. You will be paid your wages in full on the Day of Resurrection. Anyone who is distanced from the Fire and admitted to the Garden has triumphed. The life of this world is just the enjoyment of delusion. (Surah Al Imran: 185)**

**They said, "Glory be to You! We have no knowledge except what You have taught us. You are the All-Knowing, the All-Wise." (Surat al-Baqara: 32)**

# The Deception of Evolution



*Appendix*





arwinism, in other words the theory of evolution, was put forward with the aim of denying the fact of creation, but is in truth nothing but failed, unscientific nonsense. This theory, which claims that life emerged by chance from inanimate matter, was invalidated by the scientific evidence of miraculous order in the universe and in living things. In this way, science confirmed the fact that God created the universe and the living things in it. The propaganda carried out today in order to keep the theory of evolution alive is based solely on the distortion of the scientific facts, biased interpretation, and lies and falsehoods disguised as science.

Yet this propaganda cannot conceal the truth. The fact that the theory of evolution is the greatest deception in the history of science has been expressed more and more in the scientific world over the last 20-30 years. Research carried out after the 1980s in particular has revealed that the claims of Darwinism are totally unfounded, something that has been stated by a large number of scientists. In the United States in particular, many scientists from such different fields as biology, biochemistry and paleontology recognize the invalidity of Darwinism and employ the fact of creation to account for the origin of life.

We have examined the collapse of the theory of evolution and the proofs of creation in great scientific detail in many of our works, and are still continuing to do so. Given the enormous importance of this subject, it will be of great benefit to summarize it here.

## The Scientific Collapse of Darwinism

Although this doctrine goes back as far as ancient Greece, the theory of evolution was advanced extensively in the nineteenth century. The most important development that made it the top topic of the world of science was Charles Darwin's *The Origin of Species*, published in 1859. In this book, he denied that God created different living species on Earth separately, for he claimed that all living beings had a common ancestor and had diversified over time through small changes. Darwin's theory was not based on any concrete scientific finding; as he also accepted,



it was just an "assumption." Moreover, as *Charles Darwin* confessed in the long chapter of his book titled "Difficulties on Theory," the theory failed in the face of many critical questions.

Darwin invested all of his hopes in new scientific discoveries, which he expected to solve these difficulties. However, contrary to his expectations, scientific findings expanded the dimensions of these difficulties. The defeat of Darwinism in the face of science can be reviewed under three basic topics:

- 1) The theory cannot explain how life originated on Earth.
- 2) No scientific finding shows that the "evolutionary mechanisms" proposed by the theory have any evolutionary power at all.
- 3) The fossil record proves the exact opposite of what the theory suggests.

In this section, we will examine these three basic points in general outlines:



### **The First Insurmountable Step: The Origin of Life**

The theory of evolution posits that all living species evolved from a single living cell that emerged on the primitive Earth 3.8 billion years ago. How a single cell could generate millions of complex living species and, if such an evolution really occurred, why traces of it cannot be observed in the fossil record are some of the questions that the theory cannot answer. However, first and foremost, we need to ask: How did this "first cell" originate?

Since the theory of evolution denies creation and any kind of supernatural intervention, it maintains that the "first cell" originated coincidentally within the laws of nature, without any design, plan or arrangement. According to the theory, inanimate matter must have produced a living cell as a result of coincidences. Such a claim, however, is inconsistent with the most unassailable rules of biology.

### **"Life Comes From Life"**

In his book, Darwin never referred to the origin of life. The primitive understanding of science in his time rested on the assumption that living beings had a very simple structure. Since medieval times, spontaneous generation, which asserts that non-living materials came together to form living organisms, had been widely accepted. It was commonly believed that insects came into being from food leftovers, and mice from wheat. Interesting experiments were conducted to prove this theory. Some wheat was placed on a dirty piece of cloth, and it was believed that mice would originate from it after a while.

Similarly, maggots developing in rotting meat was assumed to be evidence of spontaneous generation. However, it was later understood that worms did not appear on meat spontaneously, but were

carried there by flies in the form of larvae, invisible to the naked eye.

Even when Darwin wrote *The Origin of Species*, the belief that bacteria could come into existence from non-living matter was widely accepted in the world of science.

However, five years after the publication of Darwin's book, Louis Pasteur announced his results after long studies and experiments, that disproved spontaneous generation, a cornerstone of Darwin's theory. In his triumphal lecture at the Sorbonne in 1864, Pasteur said: "Never will the doctrine of spontaneous generation recover from the mortal blow struck by this simple experiment."<sup>59</sup>

For a long time, advocates of the theory of evolution resisted these findings. However, as the development of science unraveled the complex structure of the cell of a living being, the idea that life could come into being coincidentally faced an even greater impasse.

### **Inconclusive Efforts of the Twentieth Century**

The first evolutionist who took up the subject of the origin of life in the twentieth century was the renowned Russian biologist Alexander Oparin. With various theses he advanced in the 1930s, he tried to prove that a living cell could originate by coincidence. These studies, however, were doomed to failure, and Oparin had to make the following confession:

Unfortunately, however, the problem of the origin of the cell is perhaps the most obscure point in the whole study of the evolution of organisms.<sup>60</sup>

Evolutionist followers of Oparin tried to carry

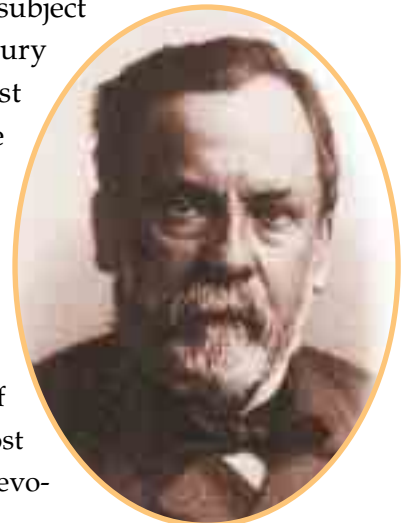

*Louis Pasteur*



out experiments to solve this problem. The best known experiment was carried out by the American chemist Stanley Miller in 1953. Combining the gases he alleged to have existed in the primordial Earth's atmosphere in an experiment set-up, and adding energy to the mixture, Miller synthesized several organic molecules (amino acids) present in the structure of proteins.

Barely a few years had passed before it was revealed that this experiment, which was then presented as an important step in the name of evolution, was invalid, for the atmosphere used in the experiment was very different from the real Earth conditions.<sup>61</sup>

After a long silence, Miller confessed that the atmosphere medium he used was unrealistic.<sup>62</sup>

All the evolutionists' efforts throughout the twentieth century to explain the origin of life ended in failure. The geochemist Jeffrey Bada, from the San Diego Scripps Institute accepts this fact in an article published in *Earth* magazine in 1998:

Today as we leave the twentieth century, we still face the biggest unsolved problem that we had when we entered the twentieth century: How did life originate on Earth?<sup>63</sup>

### **The Complex Structure of Life**

The primary reason why the theory of evolution ended up in such a great impasse regarding the origin of life is that even those living organisms deemed to be the simplest have incredibly complex structures. The cell of a living thing is more complex than all of our man-made technological products. Today, even in the most developed laboratories of the world, a living cell cannot be produced by bringing organic chemicals together.

The conditions required for the formation of a cell are too great in quantity to be explained away by coincidences. The probability of proteins, the building blocks of a cell, being synthesized coincidentally, is 1 in  $10^{950}$  for an average protein made up of 500 amino acids. In mathematics, a probability smaller than 1 over  $10^{50}$  is considered to be impossible in practical terms.

The DNA molecule, which is located in the nucleus of a cell and which stores genetic information, is an incredible databank. If the information coded in DNA were written down, it would make a giant library consisting of an estimated 900 volumes of encyclopedias consisting of 500 pages each.



*Alexander Oparin*



*One of the evolutionists' gravest deceptions is the way they imagine that life could have emerged spontaneously on what they refer to as the primitive earth, represented in the picture above. They tried to prove these claims with such studies as the Miller experiment. Yet they again suffered defeat in the face of the scientific facts: The results obtained in the 1970s proved that the atmosphere on what they describe as the primitive earth was totally unsuited to life.*



Harun Yahya

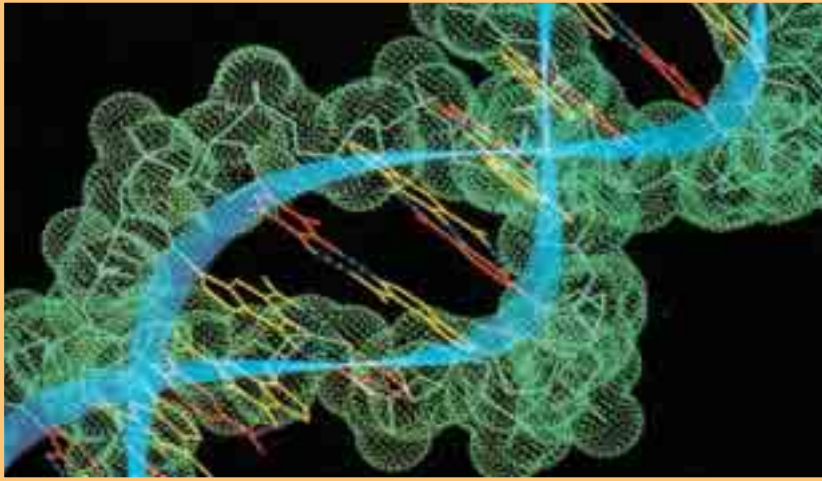

*One of the facts nullifying the theory of evolution is the incredibly complex structure of life. The DNA molecule, located in the nucleus of cells of living beings, is a sort of databank formed of the arrangement of four different molecules in different sequences. It contains the codes of all the physical traits of that living being. When the human DNA is put into writing, it is calculated that this would result in an encyclopedia made up of 900 volumes. Unquestionably, such extraordinary information definitively refutes the concept of coincidence.*

A very interesting dilemma emerges at this point: DNA can replicate itself only with the help of some specialized proteins (enzymes). However, the synthesis of these enzymes can be realized only by the information coded in DNA. As they both depend on each other, they have to exist at the same time for replication. This brings the scenario that life originated by itself to a deadlock. Prof. Leslie Orgel, an evolutionist of repute from the University of San Diego, California, confesses this fact in the September 1994 issue of the *Scientific American* magazine:

It is extremely improbable that proteins and nucleic acids, both of which are structurally complex, arose spontaneously in the same

Adnan Oktar

place at the same time. Yet it also seems impossible to have one without the other. And so, at first glance, one might have to conclude that life could never, in fact, have originated by chemical means.<sup>64</sup>

No doubt, if it is impossible for life to have originated from natural causes, then it has to be accepted that life was "created" in a supernatural way. This fact explicitly invalidates the theory of evolution, whose main purpose is to deny creation.

### **Imaginary Mechanism of Evolution**

The second important point that negates Darwin's theory is that both concepts put forward by the theory as "evolutionary mechanisms" were understood to have, in reality, no evolutionary power.

Darwin based his evolution allegation entirely on the mechanism of "natural selection." The importance he placed on this mechanism was evident in the name of his book: *The Origin of Species, By Means of Natural Selection...*

Natural selection holds that those living things that are stronger and more suited to the natural conditions of their habitats will survive in the struggle for life. For example, in a deer herd under the threat of attack by wild animals, those that can run faster will survive. Therefore, the deer herd will be comprised of faster and stronger individuals. However, unquestionably, this mechanism will not cause deer to evolve and transform themselves into another living species, for instance, horses.

Therefore, the mechanism of natural selection has no evolutionary power. Darwin was also aware of this fact and had to state this in his book *The Origin of Species*:

Natural selection can do nothing until favourable individual differences or variations occur.<sup>65</sup>



### Lamarck's Impact

So, how could these "favorable variations" occur? Darwin tried to answer this question from the standpoint of the primitive understanding of science at that time. According to the French biologist Chevalier de Lamarck (1744-1829), who lived before Darwin, living creatures passed on the traits they acquired during their lifetime to the next generation. He asserted that these traits, which accumulated from one generation to another, caused new species to be formed. For instance, he claimed that giraffes evolved from antelopes; as they struggled to eat the leaves of high trees, their necks were extended from generation to generation.

Darwin also gave similar examples. In his book *The Origin of Species*, for instance, he said that some bears going into water to find food transformed themselves into whales over time.<sup>66</sup>

However, the laws of inheritance discovered by Gregor Mendel (1822-84) and verified by the science of genetics, which flourished in the twentieth century, utterly demolished the legend that acquired traits were passed on to subsequent generations. Thus, natural selection fell out of favor as an evolutionary mechanism.



*Lamarck believed that giraffes evolved from such animals as antelopes. In his view, the necks of these grass-eating animals gradually grew longer, and they eventually turned into giraffes. The laws of inheritance discovered by Mendel in 1865 proved that it was impossible for properties acquired during life to be handed on to subsequent generations. Lamarck's giraffe fairy tale was thus consigned to the wastebin of history.*

### **Neo-Darwinism and Mutations**

In order to find a solution, Darwinists advanced the "Modern Synthetic Theory," or as it is more commonly known, Neo-Darwinism, at the end of the 1930s. Neo-Darwinism added mutations, which are distortions formed in the genes of living beings due to such external factors as radiation or replication errors, as the "cause of favorable variations" in addition to natural mutation.

Today, the model that stands for evolution in the world is Neo-Darwinism. The theory maintains that millions of living beings formed as a result of a process whereby numerous complex organs of these organisms (e.g., ears, eyes, lungs, and wings) underwent "mutations," that is, genetic disorders. Yet, there is an outright scientific fact that totally undermines this theory: Mutations do not cause living beings to develop; on the contrary, they are always harmful.

The reason for this is very simple: DNA has a very complex structure, and random effects can only harm it. The American geneticist B. G. Ranganathan explains this as follows:

First, genuine mutations are very rare in nature. Secondly, most mutations are harmful since they are random, rather than orderly changes in the structure of genes; any random change in a highly ordered system will be for the worse, not for the better. For example, if an earthquake were to shake a highly ordered structure such as a building, there would be a random change in the framework of the building which, in all probability, would not be an improvement.<sup>67</sup>

Not surprisingly, no mutation example, which is useful, that is, which is observed to develop the genetic code, has been observed so far. All mutations have proved to be harmful. It was understood that mutation, which is presented as an "evolutionary mechanism," is actually a genetic occurrence that harms living things, and leaves them





*Accidental mutations develop into defects in humans as well as other living beings, as seen in this picture.*

disabled. (The most common effect of mutation on human beings is cancer.) Of course, a destructive mechanism cannot be an "evolutionary mechanism." Natural selection, on the other hand, "can do nothing by itself," as Darwin also accepted. This fact shows us that there is no "evolutionary mechanism" in nature. Since no evolutionary mechanism exists, no such any imaginary process called "evolution" could have taken place.

### **The Fossil Record: No Sign of Intermediate Forms**

The clearest evidence that the scenario suggested by the theory of evolution did not take place is the fossil record.

According to this theory, every living species has sprung from a predecessor. A previously existing species turned into something else over time and all species have come into being in this way. In other words, this transformation proceeds gradually over millions of years.

Had this been the case, numerous intermediary species should have existed and lived within this long transformation period.

For instance, some half-fish/half-reptiles should have lived in the

## LIVING FOSSILS REFUTE EVOLUTION

---



150- to 100-million-year-old starfish fossil  
(L. Cretaceous period)



450-million-year-old horseshoe crab from the Ordovician period



200- to 150-million-year-old dragonfly fossil from the recent Jurassic period



150- to 100-million-year-old fossil shrimp from the L. Cretaceous period

Different groups of living things suddenly emerged with no similar ancestors behind them, and remained static for millions of years, undergoing no changes at all.



past which had acquired some reptilian traits in addition to the fish traits they already had. Or there should have existed some reptile-birds, which acquired some bird traits in addition to the reptilian traits they already had. Since these would be in a transitional phase, they should be disabled, defective, crippled living beings. Evolutionists refer to these imaginary creatures, which they believe to have lived in the past, as "transitional forms."

If such animals ever really existed, there should be millions and even billions of them in number and variety. More importantly, the remains of these strange creatures should be present in the fossil record. In *The Origin of Species*, Darwin explained:

If my theory be true, numberless intermediate varieties, linking most closely all of the species of the same group together must assuredly have existed... Consequently, evidence of their former existence could be found only amongst fossil remains.<sup>68</sup>

### **Darwin's Hopes Shattered**

However, although evolutionists have been making strenuous efforts to find fossils since the middle of the nineteenth century all over the world, no transitional forms have yet been uncovered. All of the fossils, contrary to the evolutionists' expectations, show that life appeared on Earth all of a sudden and fully-formed.

One famous British paleontologist, Derek V. Ager, admits this fact, even though he is an evolutionist:

The point emerges that if we examine the fossil record in detail, whether at the level of orders or of species, we find – over and over again – not gradual evolution, but the sudden explosion of one group at the expense of another.<sup>69</sup>

This means that in the fossil record, all living species suddenly emerge as fully formed, without any intermediate forms in between. This is just the opposite of Darwin's assumptions. Also, this is very strong evidence that all living things are created. The only explanation of a living species emerging suddenly and complete in every detail without any evolutionary ancestor is that it was created. This fact is admitted also by the widely known evolutionist biologist Douglas Futuyma:

Creation and evolution, between them, exhaust the possible explanations for the origin of living things. Organisms either appeared on the earth fully developed or they did not. If they did not, they must have developed from pre-existing species by some process of modification. If they did appear in a fully developed state, they must indeed have been created by some omnipotent intelligence.<sup>70</sup>

Fossils show that living beings emerged fully developed and in a perfect state on the Earth. That means that "the origin of species," contrary to Darwin's supposition, is not evolution, but creation.

### **The Tale of Human Evolution**

The subject most often brought up by advocates of the theory of evolution is the subject of the origin of man. The Darwinist claim holds that modern man evolved from ape-like creatures. During this alleged evolutionary process, which is supposed to have started 4-5 million years ago, some "transitional forms" between modern man and his ancestors are supposed to have existed. According to this completely imaginary scenario, four basic "categories" are listed:

1. *Australopithecus*
2. *Homo habilis*
3. *Homo erectus*
4. *Homo sapiens*



Harun Yahya

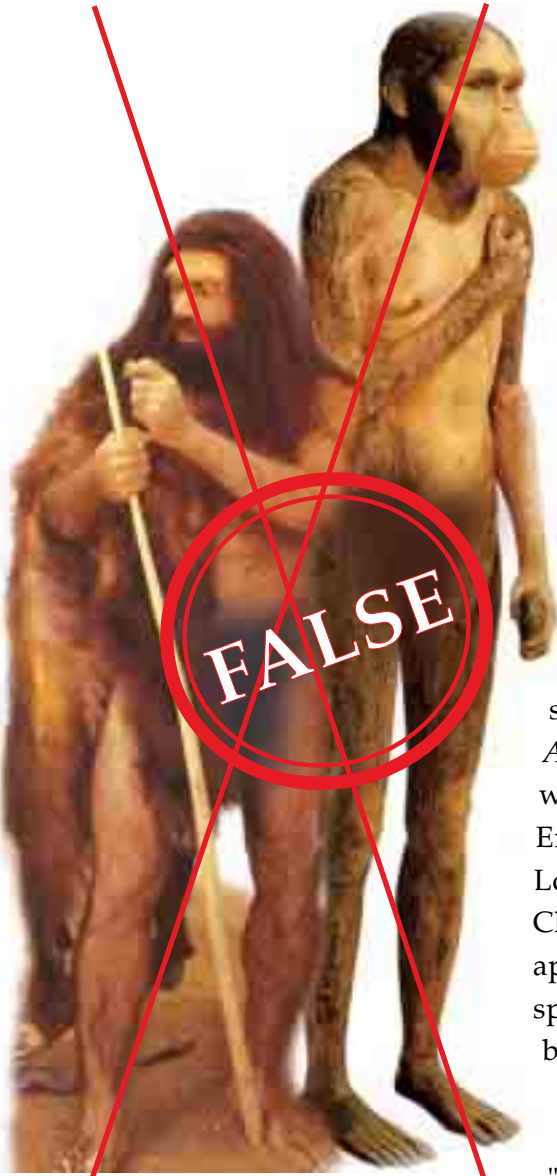

Evolutionist newspapers and magazines often print pictures of primitive man. The only available source for these pictures is the imagination of the artist. Evolutionary theory has been so dented by scientific data that today we see less and less of it in the serious press.

Evolutionists call man's so-called first ape-like ancestors *Australopithecus*, which means "South African ape." These living beings are actually nothing but an old ape species that has become extinct. Extensive research done on various *Australopithecus* specimens by two world famous anatomists from England and the USA, namely, Lord Solly Zuckerman and Prof. Charles Oxnard, shows that these apes belonged to an ordinary ape species that became extinct and bore no resemblance to humans.<sup>71</sup>

Evolutionists classify the next stage of human evolution as "homo," that is "man." According

Adnan Oktar

to their claim, the living beings in the Homo series are more developed than *Australopithecus*. Evolutionists devise a fanciful evolution scheme by arranging different fossils of these creatures in a particular order. This scheme is imaginary because it has never been proved that there is an evolutionary relation between these different classes. Ernst Mayr, one of the twentieth century's most important evolutionists, contends in his book *One Long Argument* that "particularly historical [puzzles] such as the origin of life or of Homo sapiens, are extremely difficult and may even resist a final, satisfying explanation."<sup>72</sup>

By outlining the link chain as *Australopithecus* > *Homo habilis* > *Homo erectus* > *Homo sapiens*, evolutionists imply that each of these species is one another's ancestor. However, recent findings of paleo-anthropologists have revealed that *Australopithecus*, *Homo habilis*, and *Homo erectus* lived at different parts of the world at the same time.<sup>73</sup>

Moreover, a certain segment of humans classified as *Homo erectus* have lived up until very modern times. *Homo sapiens neandarthalensis* and *Homo sapiens sapiens* (modern man) co-existed in the same region.<sup>74</sup>

This situation apparently indicates the invalidity of the claim that they are ancestors of one another. Stephen Jay Gould explained this deadlock of the theory of evolution, although he was himself one of the leading advocates of evolution in the twentieth century:

What has become of our ladder if there are three coexisting lineages of hominids (*A. africanus*, the robust australopithecines, and *H. habilis*), none clearly derived from another? Moreover, none of the three display any evolutionary trends during their tenure on earth.<sup>75</sup>

Put briefly, the scenario of human evolution, which is "upheld" with the help of various drawings of some "half ape, half human" creatures appearing in the media and course books, that is, frankly, by means of propaganda, is nothing but a tale with no scientific founda-



tion.

Lord Solly Zuckerman, one of the most famous and respected scientists in the U.K., who carried out research on this subject for years and studied *Australopithecus* fossils for 15 years, finally concluded, despite being an evolutionist himself, that there is, in fact, no such family tree branching out from ape-like creatures to man.

Zuckerman also made an interesting "spectrum of science" ranging from those he considered scientific to those he considered unscientific. According to Zuckerman's spectrum, the most "scientific"—that is, depending on concrete data—fields of science are chemistry and physics. After them come the biological sciences and then the social sciences. At the far end of the spectrum, which is the part considered to be most "unscientific," are "extra-sensory perception"—concepts such as telepathy and sixth sense—and finally "human evolution." Zuckerman explains his reasoning:

We then move right off the register of objective truth into those fields of presumed biological science, like extrasensory perception or the interpretation of man's fossil history, where to the faithful [evolutionist] anything is possible – and where the ardent believer [in evolution] is sometimes able to believe several contradictory things at the same time.<sup>76</sup>

The tale of human evolution boils down to nothing but the prejudiced interpretations of some fossils unearthed by certain people, who blindly adhere to their theory.

### **Darwinian Formula!**

Besides all the technical evidence we have dealt with so far, let us now for once, examine what kind of a superstition the evolutionists

have with an example so simple as to be understood even by children:

The theory of evolution asserts that life is formed by chance. According to this claim, lifeless and unconscious atoms came together to form the cell and then they somehow formed other living things, including man. Let us think about that. When we bring together the elements that are the building-blocks of life such as carbon, phosphorus, nitrogen and potassium, only a heap is formed. No matter what treatments it undergoes, this atomic heap cannot form even a single living being. If you like, let us formulate an "experiment" on this subject and let us examine on the behalf of evolutionists what they really claim without pronouncing loudly under the name "Darwinian formula":

Let evolutionists put plenty of materials present in the composition of living things such as phosphorus, nitrogen, carbon, oxygen, iron, and magnesium into big barrels. Moreover, let them add in these barrels any material that does not exist under normal conditions, but they think as necessary. Let them add in this mixture as many amino acids and as many proteins—a single one of which has a formation probability of 1 over  $10^{950}$ —as they like. Let them expose these mixtures to as much heat and moisture as they like. Let them stir these with whatever technologically developed device they like. Let them put the foremost scientists beside these barrels. Let these experts wait in turn beside these barrels for billions, and even trillions of years. Let them be free to use all kinds of conditions they believe to be necessary for a human's formation. No matter what they do, they cannot produce from these barrels a human, say a professor that examines his cell structure under the electron microscope. They cannot produce giraffes, lions, bees, canaries, horses, dolphins, roses, orchids, lilies, carnations, bananas, oranges, apples, dates, tomatoes, melons, watermelons, figs, olives, grapes, peaches, peafowls, pheasants, mul-



ticoloured butterflies, or millions of other living beings such as these. Indeed, they could not obtain even a single cell of any one of them.

Briefly, unconscious atoms cannot form the cell by coming together. They cannot take a new decision and divide this cell into two, then take other decisions and create the professors who first invent the electron microscope and then examine their own cell structure under that microscope. Matter is an unconscious, lifeless heap, and it comes to life with God's superior creation.

The theory of evolution, which claims the opposite, is a total fallacy completely contrary to reason. Thinking even a little bit on the claims of evolutionists discloses this reality, just as in the above example.

### **Technology in the Eye and the Ear**

Another subject that remains unanswered by evolutionary theory is the excellent quality of perception in the eye and the ear.

Before passing on to the subject of the eye, let us briefly answer the question of how we see. Light rays coming from an object fall oppositely on the eye's retina. Here, these light rays are transmitted into electric signals by cells and reach a tiny spot at the back of the brain, the "center of vision." These electric signals are perceived in this center as an image after a series of processes. With this technical background, let us do some thinking.

The brain is insulated from light. That means that its inside is completely dark, and that no light reaches the place where it is located. Thus, the "center of vision" is never touched by light and may even be the darkest place you have ever known. However, you observe a luminous, bright world in this pitch darkness.

The image formed in the eye is so sharp and distinct that even the technology of the twentieth century has not been able to attain it. For instance, look at the book you are reading, your hands with which you are holding it, and then lift your head and look around you. Have you ever seen such a sharp and distinct image as this one at any other place? Even the most developed television screen produced by the greatest television producer in the world cannot provide such a sharp image for you. This is a three-dimensional, colored, and extremely sharp image. For more than 100 years, thousands of engineers have been trying to achieve this sharpness. Factories, huge premises were established, much research has been done, plans and designs have been made for this purpose. Again, look at a TV screen and the book you hold in your hands. You will see that there is a big difference in sharpness and distinction. Moreover, the TV screen shows you a two-dimensional image, whereas with your eyes, you watch a three-dimensional perspective with depth.

For many years, tens of thousands of engineers have tried to make a three-dimensional TV and achieve the vision quality of the eye. Yes, they have made a three-dimensional television system, but it is not possible to watch it without putting on special 3-D glasses; moreover, it is only an artificial three-dimension. The background is more blurred, the foreground appears like a paper setting. Never has it been possible to produce a sharp and distinct vision like that of the eye. In both the camera and the television, there is a loss of image quality.

Evolutionists claim that the mechanism producing this sharp and distinct image has been formed by chance. Now, if somebody told you that the television in your room was formed as a result of chance, that all of its atoms just happened to come together and make up this device that produces an image, what would you think? How can





*Compared to cameras and sound recording devices, the eye and ear are much more complex, much more successful and possess far superior features to these products of high technology.*

atoms do what thousands of people cannot?

If a device producing a more primitive image than the eye could not have been formed by chance, then it is very evident that the eye and the image seen by the eye could not have been formed by chance. The same situation applies to the ear. The outer ear picks up the available sounds by the auricle and directs them to the middle ear, the middle ear transmits the sound vibrations by intensifying them, and the inner ear sends these vibrations to the brain by translating them into electric signals. Just as with the eye, the act of hearing finalizes in the center of hearing in the brain.

The situation in the eye is also true for the ear. That is, the brain is insulated from sound just as it is from light. It does not let any sound

in. Therefore, no matter how noisy is the outside, the inside of the brain is completely silent. Nevertheless, the sharpest sounds are perceived in the brain. In your completely silent brain, you listen to symphonies, and hear all of the noises in a crowded place. However, were the sound level in your brain measured by a precise device at that moment, complete silence would be found to be prevailing there.

As is the case with imagery, decades of effort have been spent in trying to generate and reproduce sound that is faithful to the original. The results of these efforts are sound recorders, high-fidelity systems, and systems for sensing sound. Despite all of this technology and the thousands of engineers and experts who have been working on this endeavor, no sound has yet been obtained that has the same sharpness and clarity as the sound perceived by the ear. Think of the highest-quality hi-fi systems produced by the largest company in the music industry. Even in these devices, when sound is recorded some of it is lost; or when you turn on a hi-fi you always hear a hissing sound before the music starts. However, the sounds that are the products of the human body's technology are extremely sharp and clear. A human ear never perceives a sound accompanied by a hissing sound or with atmospherics as does a hi-fi; rather, it perceives sound exactly as it is, sharp and clear. This is the way it has been since the creation of man.

So far, no man-made visual or recording apparatus has been as sensitive and successful in perceiving sensory data as are the eye and the ear. However, as far as seeing and hearing are concerned, a far greater truth lies beyond all this.

### **To Whom Does the Consciousness that Sees and Hears within the Brain Belong?**

Who watches an alluring world in the brain, listens to symphonies and the twittering of birds, and smells the rose?



The stimulations coming from a person's eyes, ears, and nose travel to the brain as electro-chemical nerve impulses. In biology, physiology, and biochemistry books, you can find many details about how this image forms in the brain. However, you will never come across the most important fact: Who perceives these electro-chemical nerve impulses as images, sounds, odors, and sensory events in the brain? There is a consciousness in the brain that perceives all this without feeling any need for an eye, an ear, and a nose. To whom does this consciousness belong? Of course it does not belong to the nerves, the fat layer, and neurons comprising the brain. This is why Darwinist-materialists, who believe that everything is comprised of matter, cannot answer these questions.

For this consciousness is the spirit created by God, which needs neither the eye to watch the images nor the ear to hear the sounds. Furthermore, it does not need the brain to think.

Everyone who reads this explicit and scientific fact should ponder on Almighty God, and fear and seek refuge in Him, for He squeezes the entire universe in a pitch-dark place of a few cubic centimeters in a three-dimensional, colored, shadowy, and luminous form.

### **A Materialist Faith**

The information we have presented so far shows us that the theory of evolution is incompatible with scientific findings. The theory's claim regarding the origin of life is inconsistent with science, the evolutionary mechanisms it proposes have no evolutionary power, and fossils demonstrate that the required intermediate forms have never existed. So, it certainly follows that the theory of evolution should be pushed aside as an unscientific idea. This is how many ideas, such as the Earth-centered universe model, have been taken out of the agenda of science through-

out history.

However, the theory of evolution is kept on the agenda of science. Some people even try to represent criticisms directed against it as an "attack on science." Why?

The reason is that this theory is an indispensable dogmatic belief for some circles. These circles are blindly devoted to materialist philosophy and adopt Darwinism because it is the only materialist explanation that can be put forward to explain the workings of nature.

Interestingly enough, they also confess this fact from time to time. A well-known geneticist and an outspoken evolutionist, Richard C. Lewontin from Harvard University, confesses that he is "first and foremost a materialist and then a scientist":

It is not that the methods and institutions of science somehow compel us accept a material explanation of the phenomenal world, but, on the contrary, that we are forced by our a priori adherence to material causes to create an apparatus of investigation and a set of concepts that produce material explanations, no matter how counter-intuitive, no matter how mystifying to the uninitiated. Moreover, that materialism is absolute, so we cannot allow a Divine Foot in the door.<sup>77</sup>

These are explicit statements that Darwinism is a dogma kept alive just for the sake of adherence to materialism. This dogma maintains that there is no being save matter. Therefore, it argues that inanimate, unconscious matter created life. It insists that millions of different living species (e.g., birds, fish, giraffes, tigers, insects, trees, flowers, whales, and human beings) originated as a result of the interactions between matter such as pouring rain, lightning flashes, and so on, out of inanimate matter. This is a precept contrary both to reason and science. Yet Darwinists continue to defend it just so as "not to allow a Divine Foot in the door."



Harun Yahya

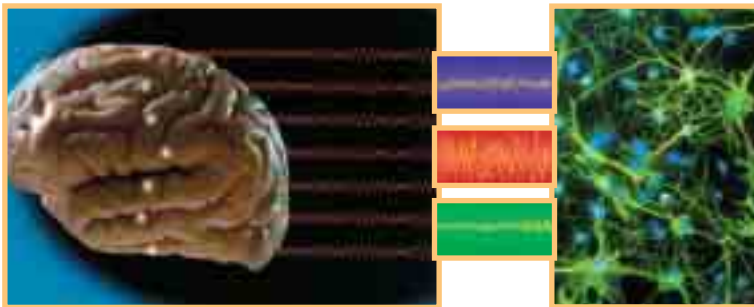

*We live our whole life in our brains. People we see, flowers we smell, music we hear, fruit we taste, the moisture we feel with our hands-all these are impressions that become "reality" in the brain. But no colors, voices or pictures exist there. We live in an environment of electrical impulses. This is no theory, but the scientific explanation of how we perceive the outside world.*

Adnan Oktar

Anyone who does not look at the origin of living beings with a materialist prejudice will see this evident truth: All living beings are works of a Creator, Who is All-Powerful, All-Wise, and All-Knowing. This Creator is God, Who created the whole universe from non-existence, designed it in the most perfect form, and fashioned all living beings.

### **The Theory of Evolution: The Most Potent Spell in the World**

Anyone free of prejudice and the influence of any particular ideology, who uses only his or her reason and logic, will clearly understand that belief in the theory of evolution, which brings to mind the superstitions of societies with no knowledge of science or civilization, is quite impossible.

As explained above, those who believe in the theory of evolution think that a few atoms and molecules thrown into a huge vat could produce thinking, reasoning professors and university students; such scientists as Einstein and Galileo; such artists as Humphrey Bogart, Frank Sinatra and Luciano Pavarotti; as well as antelopes, lemon trees, and carnations. Moreover, as the scientists and professors who believe in this nonsense are educated people, it is quite justifiable to speak of this theory as "the most potent spell in history." Never before has any other belief or idea so taken away peoples' powers of reason, refused to allow them to think intelligently and logically and hidden the truth from them as if they had been blindfolded. This is an even worse and unbelievable blindness than the totem worship in some parts of Africa, the people of Saba worshipping the Sun, the tribe of Prophet Abraham (pbuh) worshipping idols they had made with their own hands, or the people of Prophet Moses (pbuh) worshipping the Golden Calf.





*In the same way that the beliefs of people who worshipped crocodiles now seem odd and unbelievable, so the beliefs of Darwinists are just as incredible. Darwinists regard chance and lifeless, unconscious atoms as a creative force, and are as devoted to that belief as if to a religion.*

In fact, God has pointed to this lack of reason in the Qur'an. In many verses, He reveals that some peoples' minds will be closed and that they will be powerless to see the truth. Some of these verses are as follows:

**As for those who do not believe, it makes no difference to them whether you warn them or do not warn them, they will not believe. God has sealed up their hearts and hearing and over their eyes is a blindfold. They will have a terrible punishment. (Surat al-Baqara: 6-7)**

**They have hearts with which they do not understand. They have eyes with which they do not see. They have ears with which**

**they do not hear. Such people are like cattle. No, they are even further astray! They are the unaware. (Surat al-A'raf: 179)**

**Even if We opened up to them a door into heaven, and they spent the day ascending through it, they would only say: "Our eyesight is befuddled! Or rather we have been put under a spell!" (Surat al-Hijr: 14-15)**

Words cannot express just how astonishing it is that this spell should hold such a wide community in thrall, keep people from the truth, and not be broken for 150 years. It is understandable that one or a few people might believe in impossible scenarios and claims full of stupidity and illogicality. However, "magic" is the only possible explanation for people from all over the world believing that unconscious and lifeless atoms suddenly decided to come together and form a universe that functions with a flawless system of organization, discipline, reason, and consciousness; a planet named Earth with all of its features so perfectly suited to life; and living things full of countless complex systems.

In fact, the Qur'an relates the incident of Prophet Moses (pbuh) and Pharaoh to show that some people who support atheistic philosophies actually influence others by magic. When Pharaoh was told about the true religion, he told Prophet Moses (pbuh) to meet with his own magicians. When Prophet Moses (pbuh) did so, he told them to demonstrate their abilities first. The verses continue:

**He said: "You throw." And when they threw, they cast a spell on the people's eyes and caused them to feel great fear of them. They produced an extremely powerful magic. (Surat al-A'raf: 116)**

As we have seen, Pharaoh's magicians were able to deceive everyone, apart from Prophet Moses (pbuh) and those who believed in



him. However, his evidence broke the spell, or "swallowed up what they had forged," as the verse puts it:

**We revealed to Moses: "Throw down your staff." And it immediately swallowed up what they had forged. So the Truth took place and what they did was shown to be false. (Surat al-A'raf: 117-118)**

As we can see, when people realized that a spell had been cast upon them and that what they saw was just an illusion, Pharaoh's magicians lost all credibility. In the present day too, unless those who, under the influence of a similar spell, believe in these ridiculous claims under their scientific disguise and spend their lives defending them, abandon their superstitious beliefs, they also will be humiliated when the full truth emerges and the spell is broken. In fact, world-renowned British writer and philosopher Malcolm Muggeridge, who was an atheist defending evolution for some 60 years, but who subsequently realized the truth, reveals the position in which the theory of evolution would find itself in the near future in these terms:

I myself am convinced that the theory of evolution, especially the extent to which it's been applied, will be one of the great jokes in the history books in the future. Posterity will marvel that so very flimsy and dubious an hypothesis could be accepted with the incredible credulity that it has.<sup>78</sup>

That future is not far off: On the contrary, people will soon see that "chance" is not a deity, and will look back on the theory of evolution as the worst deceit and the most terrible spell in the world. That spell is already rapidly beginning to be lifted from the shoulders of people all over the world. Many people who see its true face are wondering with amazement how they could ever have been taken in by it.

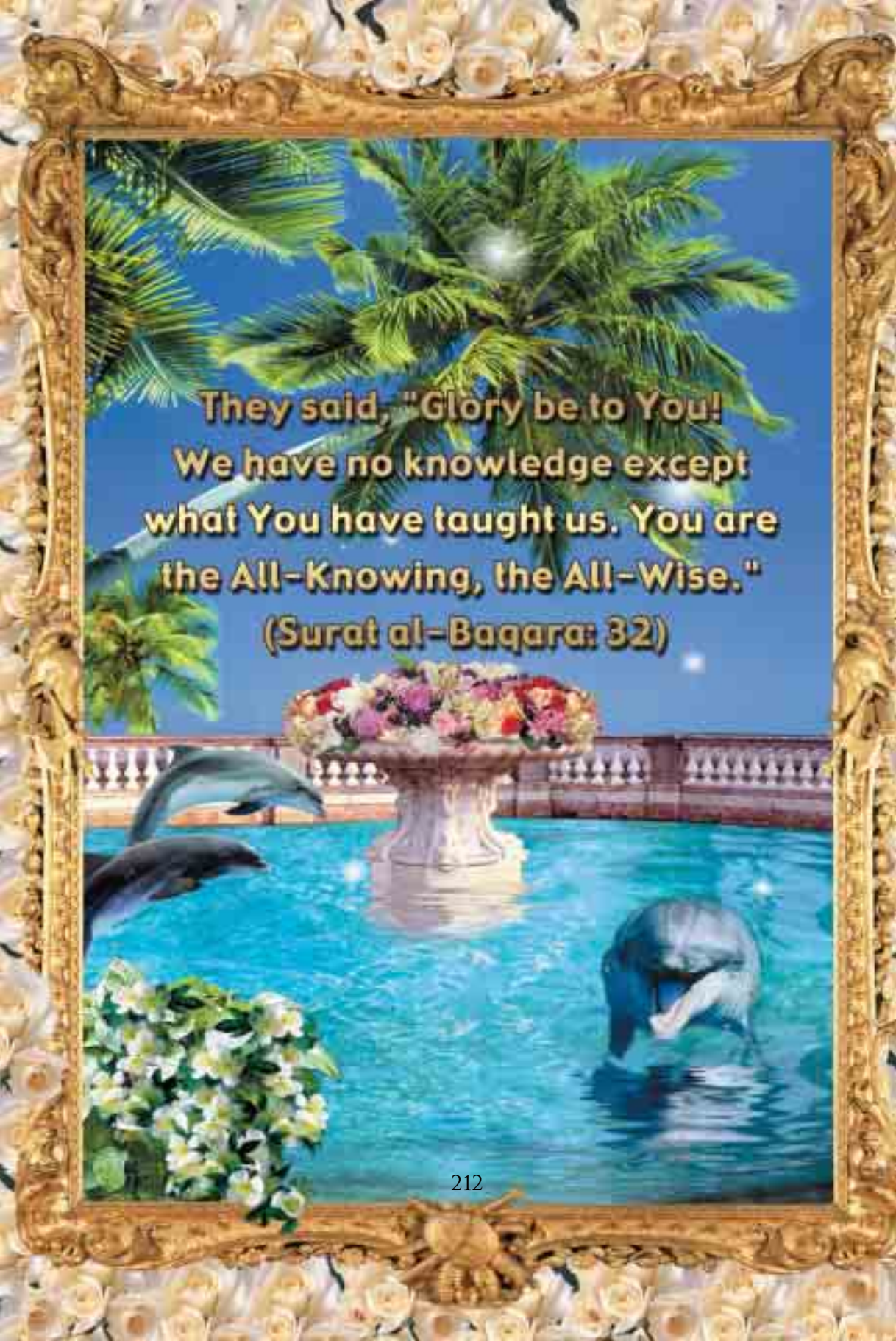

**They said, "Glory be to You!  
We have no knowledge except  
what You have taught us. You are  
the All-Knowing, the All-Wise."  
(Surat al-Baqara: 32)**



## NOTES

1. "Owls Teach Scientists to Fly Silently," *CNN.com*; <http://www.cnn.com/NATURE/9903/05/owls.enn/index.html>
2. John Brackenbury, *Insect in Flight*, Distributed in the US by Sterling; annotation copyright by Book News, Inc. Portland, March 1996, p. 11.
3. "Iste Doga" (This is Nature), *Bilim ve Teknik* (Science and Technology Magazine), TUBITAK, January 1992, no. 25, vol.290, p. 49.
4. "Fighting an enemy until the enemy dies;" [http://ant.edb.miyakyou.ac.jp/INTRODUCTION/Gakken79E/Page\\_10.html](http://ant.edb.miyakyou.ac.jp/INTRODUCTION/Gakken79E/Page_10.html)
5. "Feromonlar" (Pheromones), *Bilim ve Teknik* (Science and Technology Magazine), Zuhul Ozer, TUBITAK, August 1996, p. 45.
6. "Feromonlar" (Pheromones), *Bilim ve Teknik*, p.45.
7. "Bagworms on Landscape Plants", M.F. Potter and L.H. Townsend, <http://www.uky.edu/Agriculture/Entomology/entfacts/pdfs/entfa440.pdf>
8. Thomas C. Emmel, Brian Ph. Kenney (Editor), *Florida's Fabulous Butterflies & Moths* (Florida's Fabulous Series vol. 2), p. 9.
9. *Ibid.*, p. 76.
- 10 Christopher O'Toole, Anthony Raw, *Bees of The World*, ISBN 0-8160-1992-4, 1992, 101
11. "Feromonlar" (Pheromones), *Bilim ve Teknik*, p. 47.
12. *Ibid.*
13. "Alphabet of the Ants", James W Keefer; <http://www.frontiernet.net/~jlkeefer/ants.htm>; Tumlinson, J. H., R. M. Silverstein, J. C. Moser, R. G. Brownlee, and J. M. Ruth. 1971. Identification of the trail pheromone of a leaf-cutting ant, *Atta texana*. *Nature*, 234:pp. 348-349.
14. Katie Aust, "Non-renewable energy sources and their effect on the environment;" <http://www.annesley.sa.edu.au/amep/energyconservation/katie.htm>
15. "Hasta hayvanlar nasıl sifa bulur?" (How do sick animals find remedies?), Sinan Erten, *Bilim ve Teknik*, TUBITAK, January 1996, p.99.
16. I. D. Hume (1999), *Marsupial nutrition*, Cambridge: Cambridge University Press; <http://www.biology.iastate.edu/intop/1Australia/Australia%20papers/DigestionKoala.htm>
17. James L. Gould & Carol Grant Gould, *Olagan Dısı Yasamlar*, TUBITAK, 2.nd edition, Ankara: February 1997, p.140.
18. "Pacific Salmon", Denis Dreves,

- Creation*, June-August 1996, 18:3, pp. 26-28;  
<http://www.answersingenesis.org/creation/v18/i3/salmon.asp>
19. "Why Atlantic Salmon are Special," Atlantic Salmon Federation;  
<http://www.asf.ca/Overall/asfbrochure.pdf>
20. Donald Griffin, *Animal Engineering*, Readings from Scientific American with Introduction, The Rockefeller University W. H. Freeman Com., San Francisco, p. 55.
21. *Ibid.*, 55; Lisa Stiffler, "Research suggests pesticides disrupt how salmon smell," *Seattle Post*;  
<http://seattlepi.nwsourc.com/local/salm013.shtml>
22. *Ibid.*, p. 55.
23. For Men Of Understanding 1, Documentary Film, Okur Production.
24. "Moths and ultrasound", Kenneth D. Roeder, April 1965, *Animal Engineering*, p. 78.
25. *Ibid.*,
26. *Ibid.*, pp. 78-86.
27. Charles Darwin, *The Origin of Species: A Fascimile of the First Edition*, Harvard University Press, 1964, p. 189.
28. "The Infrared receptors of snakes", R. Igor Gamow and John F. Harris, May 1973, *Animal Engineering*, pp. 68-69.
29. *Ibid.*, p. 69.
30. "Akrebin Silahlı: Fizik" (Physics: The Scorpion's Secret Weapon), *Bilim ve Teknik*, September 2000, p. 16.; Physics World, July 2000.
31. W. Stürzl, R. Kempter and J. L. Van Hemmen, "Theory of arachnid prey localization;" <http://itb.biologie.hu-berlin.de/~kempter/Publications/2000/PhysRevLett/abstract.html>
32. Watt, W. B. 1968. Adaptive significance of pigment polymorphisms in *Colias* butterflies. I. Variation of melanin pigment in relation to thermoregulation. *Evolution* 22: pp. 437-458;  
[http://www.stanford.edu/group/CCB/Pubs/Boggs\\_pdfs/2002\\_Ellers\\_Boggs\\_Coliaswingcolor.pdf](http://www.stanford.edu/group/CCB/Pubs/Boggs_pdfs/2002_Ellers_Boggs_Coliaswingcolor.pdf)
33. "Gunes Kolektoru Gibi Kelebek" (The Solar Collector Butterfly), *Bilim ve Teknik*, April 1991, p. 49.
34. Paul A. Zahl, "The Four-eyed Fish Sees All", *National Geographic*, March 1978, vol.137, No.1, pp. 390-395.
35. Charles Darwin, *The Origin of Species: A Fascimile of the First Edition*, Harvard University Press, 1964, p. 189
36. H. S. Lipson, "A Physicist's View of Darwin's Theory", *Evolution Trends in Plants*, vol. 2, no. 1, 1988, p. 6.
37. "Hayvanlarda yon bulma" (Direction Location in Animals), *Bilim ve Teknik*, May 1995, no.330, p. 69.
38. James L. Gould & Carol Grant Gould, *Olagan Dısı Yasamlar*, TUBITAK, 5.th edition, p. 114.
39. *Ibid.*, p. 122.
40. *Ibid.*, p. 125.
41. *Ibid.*, pp/ 117-118.
42. Voet, D. Ve J.G. (1995) *Biochemistry*, 2nd edition., John Wiley and Sons, New York, pp. 1253-1259.
43. "Boceklere Ziyafet" (A Feast for Insects), *Bilim ve Teknik*, October 1997, p. 63.
44. *Ibid.*
45. "Geckos Climb by the Hairs of Their Toes", Elizabeth Pennisi, *Science* maga-



- zine, June 30, 2000.
46. "Robo-Geckos", Fenella Saunders, *Discover*, vol. 21, no. 9, September 2000; "Sticky Secrets of the Gecko Researchers have finally unlocked the mystery of the small lizard's remarkable climbing ability", Carl T. Hall, *San Fransico Chronicle Science Writer*, Monday, June 19, 2000; <http://www.sfgate.com/cgi-bin/article.cgi?file=/chronicle/archive/2000/06/19/MNC1005.DTL>
47. "Bonding", [www.ider.herts.ac.uk/school/courseware/materials/bonding.html](http://www.ider.herts.ac.uk/school/courseware/materials/bonding.html)
48. "Biomechanics: Gripping feat", Henry Gee, *Nature*, June 8, 2000; "Adhesive Force of a single gecko foot-hair", Kellar Autumn, *Nature*, June 8, 2000.
49. "Adhesive Force of a single gecko foot-hair", Kellar Autumn, *Nature*, June 8, 2000.
50. "How Fishes Swim", Sir James Gray, August 1957, *Animal Engineering*, p. 30.
51. "Hircin Erkekleri, Bariscil Disileri ile Kemikli Balıklar" (Aggressive Males, Peacable Females and Boned Fish), Gülgün Akbaba, *Bilim ve Teknik*, October 1995, no. 335, p. 75.
52. Keratin: fibrous protein: a fibrous insoluble protein that is the main structural element in hair, nails, feathers, and hooves.
53. "Hircin Erkekleri, Bariscil Disileri ile Kemikli Balıklar" (Aggressive Males, Peacable Females and Boned Fish), p. 75.
54. John Downer, *Supernature*, p. 29.
55. *Ibid.*, p. 32.
56. *Ibid.*
57. For more information: Harun Yahya, *For Men of Understanding*, Ta-Ha Publishers Ltd, January 2001.
58. "Vay bacaksiz vay" (Woe to the legless), *Sabah*, December 23, 2000
59. Sidney Fox, Klaus Dose, *Molecular Evolution and The Origin of Life*, W. H. Freeman and Company, San Francisco, 1972, p.4
60. Alexander I. Oparin, *Origin of Life*, Dover Publications, New York, 1936, 1953 (reprint), p.196
61. "New Evidence on Evolution of Early Atmosphere and Life," *Bulletin of the American Meteorological Society*, vol 63, November 1982, 1328-1330
62. Stanley Miller, *Molecular Evolution of Life: Current Status of the Prebiotic Synthesis of Small Molecules*, 1986, p.7
63. Jeffrey Bada, *Earth*, February 1998, p.40
64. Leslie E. Orgel, "The Origin of Life on Earth," *Scientific American*, vol. 271, October 1994, p.78
65. Charles Darwin, *The Origin of Species by Means of Natural Selection*, The Modern Library, New York, p.127
66. Charles Darwin, *The Origin of Species: A Facsimile of the First Edition*, Harvard University Press, 1964, p.184
67. B. G. Ranganathan, *Origins?*, Pennsylvania: The Banner of Truth Trust, 1988, p.7
68. Charles Darwin, *The Origin of Species: A Facsimile of the First Edition*, p.179

Engineering in Nature

69. Derek A. Ager, "The Nature of the Fossil Record," *Proceedings of the British Geological Association*, vol 87, 1976, p.133
70. Douglas J. Futuyma, *Science on Trial*, Pantheon Books, New York, 1983, p.197
71. Solly Zuckerman, *Beyond The Ivory Tower*, Toplinger Publications, New York, 1970, 75-14; Charles E. Oxnard, "The Place of Australopithecines in Human Evolution: Grounds for Doubt", *Nature*, vol 258, 389
72. "Could science be brought to an end by scientists' belief that they have final answers or by society's reluctance to pay the bills?" *Scientific American*, December 1992, p.20
73. Alan Walker, *Science*, vol. 207, 7 March 1980, p.1103; A. J. Kelso, *Physical Anthropology*, 1st ed., J. B. Lipincott Co., New York, 1970, p.221; M. D. Leakey, *Olduvai Gorge*, vol. 3, Cambridge University Press, Cambridge, 1971, p.272
74. Jeffrey Kluger, "Not So Extinct After All: The Primitive Homo Erectus May Have Survived Long Enough To Coexist With Modern Humans," *Time*, 23 December 1996
75. S. J. Gould, *Natural History*, vol. 85, 1976, p.30
76. Solly Zuckerman, *Beyond The Ivory Tower*, p.19
77. Richard Lewontin, "The Demon-Haunted World," *The New York Review of Books*, January 9, 1997, p.28
78. Malcolm Muggeridge, *The End of Christendom*, Grand Rapids: Eerdmans, 1980, p.43